

Best solution  
Better integration

# BIPV BUS STOP

## PV Bus Stops

### MATERIALS

- 5 mm tempered glass  
high-transparency
- 0.76 mm PVB layer
- 0.21 mm PhotoVoltaic cells
- 0.76 mm PVB layer
- 5 mm tempered glass

### Composition:



### 60 CELLS PV PANEL

#### SI-ESF-M-BIPV-CT-M156-60

Size: 1050 x 1650 x 12 mm

Weight: 47.7 kg

Matrix: 6 x 10

Transparency: 14.9 %

Power: 325 Wp

Connectors: Type 3

### CONFIGURATIONS

#### CHARACTERISTICS

	Simple	Double
N° Modules	2	4
Width (m)	1,65	1,65
Long (m)	2,25	4,40
Area (m <sup>2</sup> )	3,7	7,3
Height (m)	2,77	2,77
Max Power (Wp)	650	1300

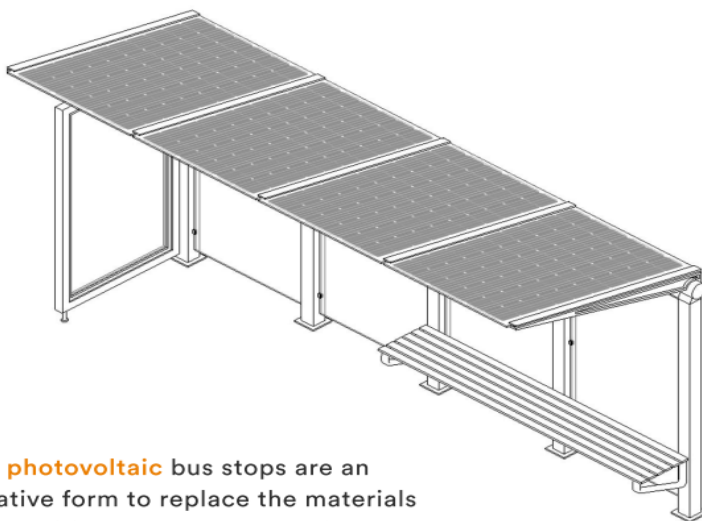
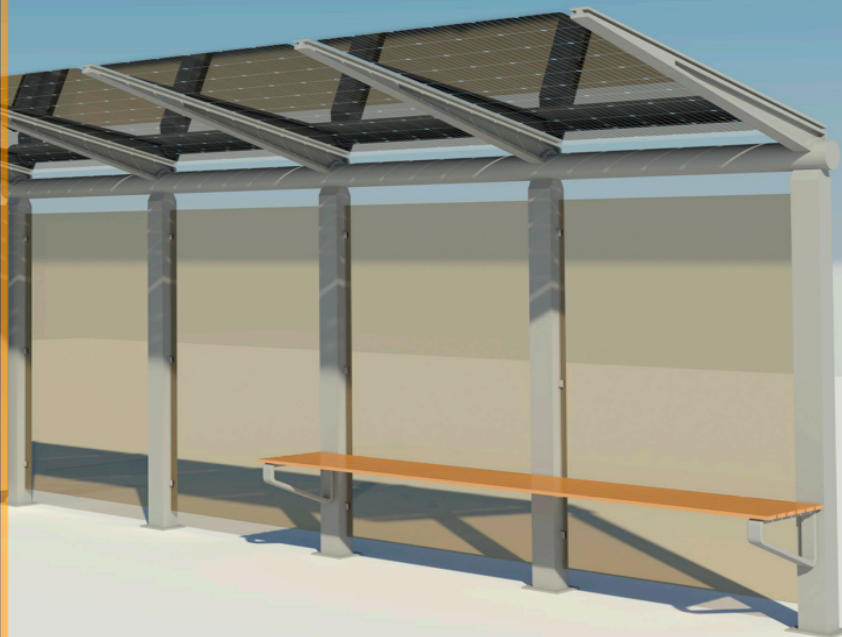

**T**he **photovoltaic** bus stops are an alternative form to replace the materials which traditionally are only used in the construction to generate **shades**.

AGS-TECH, Inc., Ph: +1 (505) 550-6501, Fx:+1 (505) 814-5778, Em: sales@agstech.net,

Web: <http://www.agstech.net>

# BIPV

One of the great advantages of Solar architectural integration **photovoltaic** glasses is that they act as a filter for ultraviolet and infrared radiation, both harmful to health, in addition to generating clean and **free energy** thanks to the sun.

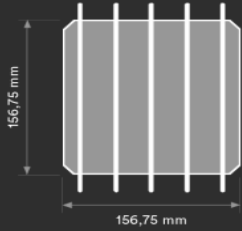

Monocrystalline  
 • sc-Si PV  
 • 5bb connection  
 • high efficiency

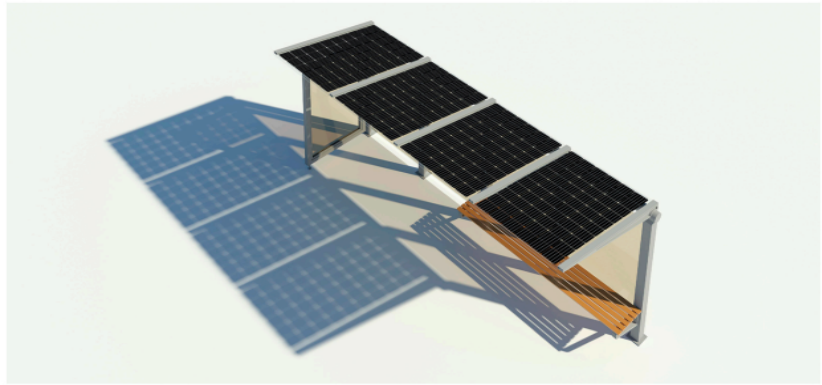
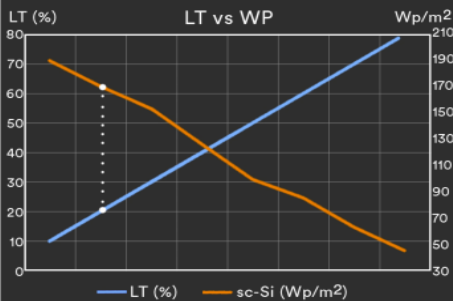
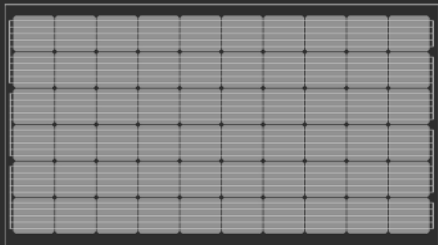

## Integrated Photovoltaic

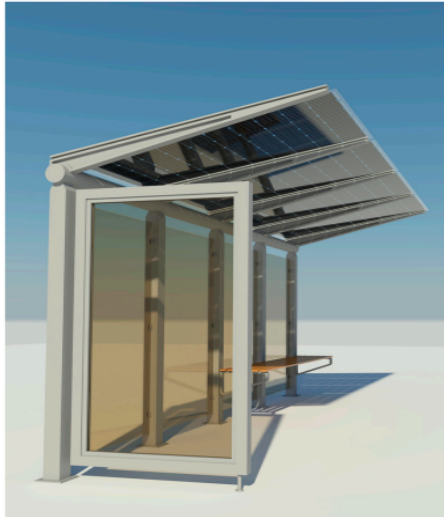

Model	SIMPLE	DOUBLE
N° modules	2 uds	4 uds
Max power	660 Wp	1300 Wp
Battery	2x45 Ah /12 Vccr/DC LiOn	2x80 Ah /12 Vccr/DC LiOn

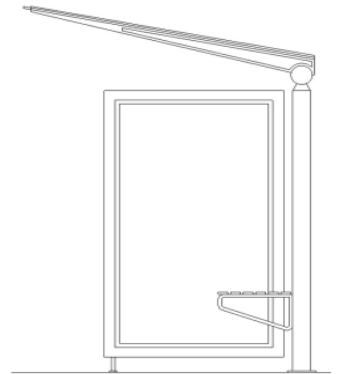

**+ Energy + Saving - Outlay - CO2**

**CE** 2014/35/EU  
EN 50583-1

**ISO** ISO 9001  
ISO 14001  
ISO 45001

**IEC** IEC/EN 61215  
IEC/EN 61730  
IEC/EN 63092

nZEB Nearly Zero Energy Buildings

ISO 1064 Protocolo GHG

WEEE 2002/96/CE

Fast Return Of Investment material

12/25 years guarantee

Photovoltaic Architecture

High satisfaction

High resistance

Low deterioration

