



***CATALOG FOR FIBER OPTIC
PASSIVE COMPONENTS***

AGS-TECH Inc.

Phone: +1-505-5506501 & +1-505-5655102

Fax: +1-505-8145778, Skype: agstech1

Email: sales@agstech.net

Website: <http://www.agstech.net>

Product Contents

Preliminary Products

CCWDM	3
Mini CWDM	4
Athermal AWG	5
Tap Photo Detector Array	7

PLC Products

Fiber Array	8
PM Fiber Array	9
PLC Splitter	10
PM PLC Splitter	13

Micro Optical Products

CWDM Mux/Demux Module	14
CWDM OADM	16
High-Isolation FWDM	18
DWDM Mux/Demux Module	19
100G DWDM OADM	21
Polarization Insensitive Fiber Isolator	22
Polarization Sensitive Free Space Isolator	23
WDM-Isolator Hybrid	24
MVOA	25

Polarization Maintaining Product Series

In-line Polarizer	26
PBC/PBS	27
PM Filter Coupler	28
PM Isolator	29
PM FWDM	30
PM Optical Circulator	31
PM MVOA	32
PM Fiber Patch-cord	33
PM Hybrid Device	34

High Power Product Series

High Power Collimator	37
High Power Isolator	38
HP PMI	39
HP MVOA	41
HP PMVOA	42

Couplers

Single Mode Single Window Coupler	43
Single Mode Dual Window Coupler	44
Dual Window Coupler Module	45

Other Products

MEMS VOA	47
Faraday Rotator Mirror	49
TAP Photo Detector	50

Compact Coarse Wavelength Division Multiplexer

1. Features

- Low Insertion Loss
- High Isolation
- Low PDL
- Compact Design
- Good channel-to-channel uniformity
- Wide Operating Wavelength:
 - From 1260nm to 1620nm
- Wide Operating Temperature:
 - From -40 °C to 85 °C
- High Reliability and Stability



2. Applications

- CWDM System
- PON Networks
- CATV Links

3. Compliance

- Telcordia GR-1209-CORE-2001
- Telcordia GR-1221-CORE-1999
- RoHS

4. Specifications

1×N CWDM Mux/Demux Module

Parameters		1x4	1x8
Center Wavelength (nm)		ITU, ITU+1	
Passband (nm)		ITU±6.5	
Operating Wavelength (nm)		1460~1620 or 1260~1620	
Channel Space (nm)		20	
Fiber Type		SMF-28e with 0.9mm Loose tube	
IL (dB)		1.0	1.5
Isolation (dB)	Adjacent Channel	30	
	Non-Adjacent Channel	40	
Ripple (dB)		0.3	
PDL (dB)		0.2	
PMD (ps)		0.1	
RL (dB)		45	
Directivity (dB)		50	
Maximum Optical Power (mw)		500	
Operating Temperature (°C)		0~70	
Storage Temperature (°C)		-40~85	
BOX Package (mm)		58×30×8	

Notes:

1. Specified without connectors.
2. Add an additional 0.2dB loss per connector.

Mini Coarse Wavelength Division Multiplexing Device

1. Features

- Low Insertion Loss
- High Isolation
- Low PDL
- Compact Design
- Good channel-to-channel uniformity
- Wide Operating Wavelength:
From 1260nm to 1620nm
- Wide Operating Temperature:
From -40°C to 85°C
- High Reliability and Stability

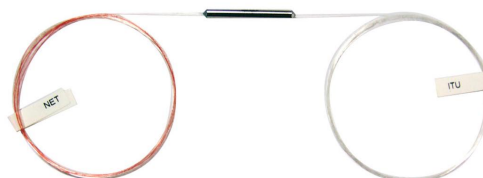

2. Applications

- CWDM System
- PON Networks
- CATV Links

3. Compliance

- Telcordia GR-1209-CORE-2001
- Telcordia GR-1221-CORE-1999
- ITU-T G.694.2
- RoHS

4. Specifications

1×2 CWDM Devices

Parameters		Values
Center wavelength (nm)		ITU, ITU+1
Passband (nm)		ITU±6.5
Operating wavelength (nm)		1460~1620 or 1260~1620
Channel Space (nm)		20
Fiber Type		SMF-28e or customer specified
IL (dB)	Transmission band	0.6
	Reflection band	0.4
Isolation (dB)	Transmission band	30
	Reflection band	12
Ripple (dB)		0.3
PDL (dB)		0.1
PMD (ps)		0.1
RL (dB)		45
Directivity (dB)		50
Maximum Optical Power (mw)		500
Operating Temperature (°C)		0~70
Storage Temperature (°C)		-40~85
Package Dimension (mm) (Φ×L)		Φ3.8*L36

Notes:

1. Specified without connectors.
2. Add an additional 0.2dB loss per connector.

Athermal Arrayed Waveguide Grating (AWG)

Athermal AWGs have equivalent performance to standard AWGs but require no electrical power for stabilization. They can be used as direct replacements for Thin Film Filters for cases where no power is available, also suitable for outdoor applications over -30°C to +70°C in access networks.

Gigalight' Athermal AWGs provide excellent optical performance, high reliability, ease of fiber handling and power saving solution in a compact package

1. Features:

- Based on proven PLC technology
- Stable & accurate wavelength response
- Low insertion loss & high isolation
- Low power consumption
- Complete passive packaging
- Gaussian or wideband passband
- 32/40/44 channel plan
- Compact size

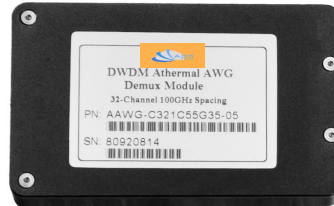

2. Applications:

- MUX/DMUX in DWDM systems
- Long haul/Metro/Access networks
- ROADM

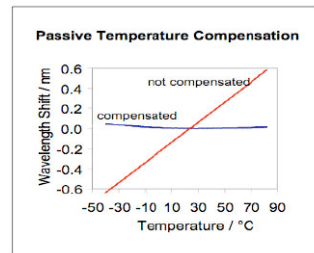

3. Compliance:

- Telcordia GR-1209-CORE
- Telcordia GR-1221-CORE
- RoHS

4. Specifications:

Optical Specification

Gaussian AAWG

Parameters	Condition	Specs			Units
		Min	Typ	Max	
Number of Channels		40			
Number Channel Spacing	100GHz	100			GHz
Cha. Center Wavelength	ITU frequency.	C -band			nm
Clear Channel Passband		±12.5			GHz
Wavelength Stability	Maximum range of the wavelength error of all channels and temperatures in average polarization.	±0.05			nm
-1 dB Channel Bandwidth	Clear channel bandwidth defined by passband shape. For each channel	0.24			nm
-3 dB Channel Bandwidth	Clear channel bandwidth defined by passband shape. For each channel	0.43			nm
Optical Insertion Loss at ITU grid	Defined as the minimum transmission at ITU wavelength for all channels. For each channel, at all temperatures and polarizations.		4.5	6.0	dB

Adjacent Channel Isolation	Insertion loss difference from the mean transmission at the ITU grid wavelength to the highest power, all polarizations, within the ITU band of the adjacent channels.	25			dB
Non-Adjacent, Channel Isolation	Insertion loss difference from the mean transmission at the ITU grid wavelength to the highest power, all polarizations, within the ITU band of the nonadjacent channels.	29			dB
Total Channel Isolation	Total cumulative insertion loss difference from the mean transmission at the ITU grid wavelength to the highest power, all polarizations, within the ITU band of all other channels, including adjacent channels.	22			dB
Insertion Loss Uniformity	Maximum range of the insertion loss variation within ITU across all channels, polarizations and temperatures.			1.5	dB
Directivity(Mux Only)	Ratio of reflected power out of any channel(other than channel n)to power in from the input channel n	40			dB
Insertion Loss Ripple	Any maxima and any minima of optical loss across ITU band, excluding boundary points, for each channel at each port			1.5	dB
Optical Return loss	Input & output ports	40			dB
PDL/Polarization Dependent Loss in Clear Channel Band	Worst-case value measured in ITU band		0.3	0.5	dB
Polarization Mode Dispersion				0.5	ps
Maximum Optical Power				24	dBm
MUX/DEMUX input/ output Monitoring range		-35		+23	dBm

- 1L Represents the worst case over a +/-0.08nm window around the ITU wavelength :
2. PDL was measured on average polarization over a +/- 0.08nm window around the ITU wavelength.

Absolute Maximum Ratings

Parameters	Specifications		Units
	Min.	Max.	
Operating Temperature	-5	65	°C
Operating Humidity	5	95	%RH
Storage Temperature	-40	+85	°C
Storage Humidity	5	95	%RH

5. Product Ordering information:

AAWG	—	□	□□	□	□□□	□	□	□
<u>Band</u>	<u>Channel</u>	<u>Spacing</u>	<u>Start wavelength</u>	<u>Filter shape</u>	<u>Fiber length</u>	<u>Connector</u>		
C : C-band	16 : 16ch	1 : 100GHz	C60 : 1529.55	G : Gaussian	1 : 0.5m	0 : None		
L : L-band	32 : 32ch	2 : 200GHz	H59 : 1529.94	B : BroadGaussian	2 : 1.0m	1 : SC/UPC		
D : C&L	40 : 40ch	X : Customize	C59 : 1530.33	F : Flat-top	3 : 1.5m	2 : SC/APC		
X : Customize	48 : 48ch		H58 : 1530.72		4 : 2.0m	3 : FC/UPC		
	xx : Customize		. . . : ITU grid		5 : 2.5m	4 : FC/APC		
					6 : 3.0m	5 : LC/UPC		
					A : 1.25m	6 : LC/APC		
					B : 1.75m	7 : ST/UPC		
					C : 2.25m	8 : MU		
					X : Customize	X : Customize		

Tap Photo Detector Array

1. Description

Our Tap Photo Detector Array(Tap PD Array) is a hybrid module that integrates thin-film tap filter, fiber array, lens array and high sensitivity PIN photodiode. The Tap PD Array is packaged array of detectors with ribbon fiber pigtailed, includes an arrays of 2~12 tap detectors, and all detectors ports are functionally independent and identical.

The products adopt a new design solution that offers very high responsibility, low dark current, compact size with wide band-width, high reliability and low cost. We can provide customized designs to meet specialized feature applications.

2. Features

- High responsibility
- Low dark current
- Low WDL and PDL
- Compact design
- Multi-channels Array

3. Applications

- Channel monitoring in DWDM systems
- Optical line protection monitoring
- ROADM Multiplexers
- Gain monitoring in Amplifier

4. Compliance

- Telcordia GR-1221-CORE
- RoHS

5. Performance specifications

Parameter	Unit	Specification			Note
Wavelength Range	nm	1530 - 1570			C band
		1570 - 1610			L band
Tap ratio		1:99	3:97	5:95	
Maximum Input Power	dBm	25	22	18	
Responsibility	mA/W	7~12	14~24	40~60	
Insertion Loss	dB	0.5	0.5	0.6	Excluding Connectors
Wavelength Dependent Loss	dB	≤0.3			
Polarization Dependent Loss	dB	≤0.1			
Return Loss	dB	≥45			
Dark Current	nA	≤5.0 (1.0 Typical)			Vr=5V, 25℃
Reverse Voltage	V	≤20			
Forward Current	mA	≤10			
Capacitance	pF	≤8.0 (5.0 Typical)			Vr=5V, f=1MHz
Bandwidth	GHz	2			RL=50Ω, -3dB
Operating Temperature	℃	-5 to 70			
Storage Temperature Range	℃	-40 to 85			

6. Optical configuration

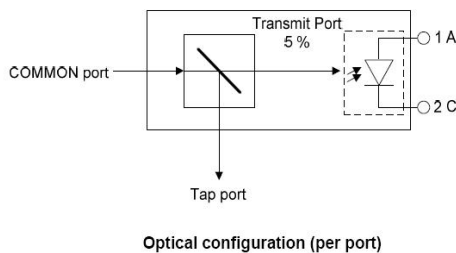

7. Pin configuration

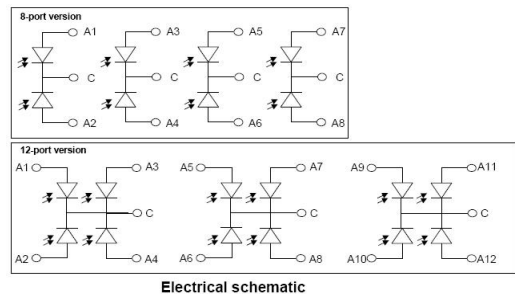

Fiber Array

1. Features

- High precise fiber core-to-core accuracy
- Low insertion loss and high reliability
- High precise angle polish and customer product available
- Wide Operating Temperature : From -40°C to 85°C

2. Applications

- Planner lightwave circuit splitter devices
- Array waveguide grating (AWG)
- Arrayed active and passive fiber devices
- MEMS devices
- Multi-channel micro-optics modules



3. Compliance

- Telcordia GR-1209-CORE
- Telcordia GR-1221-CORE
- RoHS

4. Specifications

Number of channels		1	4	8	16	32	64
Material		Quartz					
V-groove core pitch	μm	250/127(±0.5)					
Polishing angle	degree	8°(±0.3°)					
Pigtail type		250/900μm	4ribbon	8ribbon	2x8ribbon	4x8ribbon	8x8ribbon
Channel spacing	μm		250	250	127	127	127
Package (L)X(W)X(H)	mm	6 x2.5x2.5	9.5x2.5x2.5	8x3.0x2.5	11.5x3.2x2.5	11.5x5.6x2.5	11.5x10x2.5
Operating Temperature (°C)		-40~85					
Storage Temperature (°C)		-40~85					

5. Ordering information

Single Fiber Pigtail

SFA-	XX-	X-	XX-	X-	X-	X
S=Single	Form	Materials	Fiber Length	Fiber Type	Fiber Color	Polishing Angle
F=Fiber	01=D type capillary	Q=Quartz	12=1.2m	B=250μm bare fiber	C=Clear	A=+8°
A=Array	02=Quadrat capillary	X=Customized	15=1.5m	L=900μm Loose tube	W=White	V=-8°
	03=V-groove		T=900μm tight buffer	B=Blue	N=0°
					X=Customized	X=Customized

Multi-channel Fiber Array

GFA-	XX-	X-	XX-	XX-	X-	X
G	Channel Count	Materials	Core Pitch	Ribbon Fiber Length	Ribbon Fiber Color	Polishing Angle
F=Fiber	02=2 channels	Q=Quartz	25=250μm	12=minimum 1.2m	S= Standard	A=+8°
A=Array	04=4 channels	X=Customized	12=127μm	15=minimum 1.5m	X=Customized	V=-8°
	08=8 channels				N=0°
					X=Customized
	64=64 channels					

PM Fiber Array

1. Applications

- PM photonic waveguide devices
- PM-collimator arrays [PM combiner]
- Multi-PM fiber collimators
- Different laser sources

2. PM Fiber Alignment

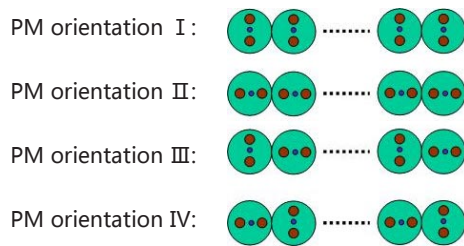

3. Specifications

Number of channels		1	4	8	16	32	64
Material		Quartz					
V-groove core pitch	μm	250/127(±0.5)					
Polishing angle	degree	8°(±0.3°)					
Fiber type		250um Panda PM fiber					
Channel spacing	μm		250	250	127	127	127
Package (L)X(W)X(H)	mm	6 x2.5x2.5	9.5x2.5x2.5	8x2.5x2.5	11.5x3.0x2.5	11.5x5.5x2.5	12X11X2.5
Operating Temperature (°C)		-40~85					
Storage Temperature (°C)		-40~85					

4. Ordering information

PMFA-	XX-	X-	XX-	XX-	X-	X
PM=PM fiber	Channel Count	Materials	Core Pitch	Fiber Length	PM orientation	Polishing Angle
F=Fiber	01=1channels	Q=Quartz	25=250μm	12=minimum 1.2m	1	A=+8°
A=Array	04=4 channels		12=127um	15=minimum 1.5m	2	V=-8°
	08=8 channels			X=Customized	3	N=0°
	16=16channels				4	X=Customized
	32=32 channels				X=Customized	

Planar Lightwave Circuit Splitter

1. Features

- Low Insertion loss
- Low PDL
- Compact Design
- Good channel-to-channel uniformity
- Wide Operating Wavelength:
From 1260nm to 1650nm
- Wide Operating Temperature:
From -40°C to 85°C
- High Reliability and Stability



2. Applications

- FTTX Systems
- PON Networks
- CATV Links
- Optical Signal Distribution



3. Compliance

- Telcordia GR-1209-CORE-2001
- Telcordia GR-1221-CORE-1999
- RoHS

4. Specifications

Table 1 – 1×N PLC Splitter

Parameters	1×2	1×4	1×8	1×16	1×32	1×64	1×128
Operating Wavelength (nm)	1260~1650						
Fiber Type	G657A1 or customer specified						
Insertion Loss (dB) (P/S Grade)	3.8/4.0	7.1/7.3	10.2/10.5	13.5/13.7	16.5/16.9	20.5/21	23.8/24.2
Loss Uniformity (dB)	0.4	0.6	0.8	1.2	1.5	2.0	2.5
Polarization Dependent Loss(dB)	0.2	0.2	0.2	0.25	0.3	0.35	0.4
Return Loss (dB)	55	55	55	55	55	55	55
Directivity (dB)	55	55	55	55	55	55	55
Wavelength Dependent Loss (dB)	0.5	0.5	0.5	0.5	0.5	0.5	0.5
Temperature Stability (-40~85 °C)(dB)	0.4	0.4	0.4	0.5	0.5	0.5	0.5
Operating Temperature (°C)	-40~85						
Storage Temperature (°C)	-40~85						
Device Dimension (mm)	40×4×4	40×4×4	40×4×4	50×4×4	50×7×4	60×12×4	N/A

Module Dimension (mm)	100×80×10	100×80×10	100×80×10	120×80×18	140×115×18	140×115×18	140×115×18
Mini-Module Dimension (mm)	60×7×4	60×7×4	60×7×4	60×12×4	80×20×6	100×40×6	N/A

Table 2 – 2×N PLC Splitter

Parameters	2×2	2×4	2×8	2×16	2×32	2×64	2×128
Operating Wavelength (nm)	1260~1650						
Fiber Type	G657A1 or customer specified						
Insertion Loss (dB) (P/S Grade)	4.2	7.6	11.0	14.4	17.5	21	24.5
Loss Uniformity (dB)	0.9	1.1	1.2	1.5	1.8	2.2	2.5
Polarization Dependent Loss(dB)	0.2	0.2	0.3	0.3	0.35	0.4	0.4
Return Loss (dB)	55	55	55	55	55	55	55
Directivity (dB)	55	55	55	55	55	55	55
Wavelength Dependent Loss (dB)	0.5	0.5	0.5	0.5	0.5	0.5	0.5
Temperature Stability (-40~85 °C)(dB)	0.4	0.4	0.4	0.5	0.5	0.5	0.5
Operating Temperature (°C)	-40~85						
Storage Temperature (°C)	-40~85						
Device Dimension (mm)	40×4×4	50×4×4	50×4×4	50×7×4	60×7×4	N/A	N/A
Module Dimension (mm)	100×80×10	100×80×10	100×80×10	120×80×18	140×115×18	140×115×18	140×115×18
Mini-Module Dimension (mm)	60×7×4	60×7×4	60×7×4	60×12×4	100×20×6	100×40×6	N/A

Notes:

1. Specified without connectors.
2. Add an additional 0.15dB loss per connector.

5. Ordering information
PLC Splitter

GPS-	-	XXX	-	X	XX	-	X	XX	-	X	X
		Port Configuration		Input fiber type	Input fiber length		Output fiber type	Output fiber length		Input connector	Output connector
G		102=1×2		B=250μm bare fiber	10=1.0m		B=250μm bare fiber	10=1.0m		0=None	0=None
P=PLC		104=1×4		L=900μm loose tube	15=1.5m		R=ribbon fiber	15=1.5m		1=FC/UPC	1=FC/UPC

S=Splitter		108=1×8		T=900µm tight buffer	20=2.0m		F=Fan out box with 900µm loose tube	20=2.0m		2=FC/APC	2=FC/APC
			3=SC/UPC	3=SC/UPC
		164=1×64								4=SC/APC	4=SC/APC
		202=2×2								5=LC/UPC	5=LC/UPC
									6=LC/APC	6=LC/APC
		232=2×32								X=Customized	X=Customized

PLC Splitter Module

GPM	-	XXX	-	XX	-	XX	-	XX	-	X	X
		Port Configuration		Modules type		Cable type		Fiber length		Input connector	Output connector
G		102=1×2		PL=140X115X18,plastic		09=0.9 C mm		10=1.0m		0=None	0=None
P=PLC splitter		104=1×4		PM=120X80X18,plastic		20=2.0 C mm		15=1.5m		1=FC/UPC	1=FC/UPC
M=Module		108=1×8		PS=100X80X10,plastic		30=3.0 C mm		20=2.0m		2=FC/APC	2=FC/APC
			MM=Mini-Module					3=SC/UPC	3=SC/UPC
		164=1×64		XX=Customized						4=SC/APC	4=SC/APC
		202=2×2								5=LC/UPC	5=LC/UPC
									6=LC/APC	6=LC/APC
		264=2×64								X=Customized	X=Customized

PLC Splitter Box

GPB	-	XXX	-	XX	-	X	X
		Port Configuration		Box type		Input connector	Output connector
G		102=1×2		LX=LGX box, metal		0=None	0=None
P=PLC splitter		104=1×4		19=19' 1U Rack-Mount Box		1=FC/UPC	1=FC/UPC
B=Box		108=1×8		TP=ODF Box		2=FC/APC	2=FC/APC
			WM=Wall-Mount Box		3=SC/UPC	3=SC/UPC
		164=1×64		XX=Customized		4=SC/APC	4=SC/APC
		202=2×2				5=LC/UPC	5=LC/UPC
					6=LC/APC	6=LC/APC
		264=2×64				X=Customized	X=Customized

PM PLC Splitter

1. Features

- Low Insertion loss
- High Extinction Ratio
- Good Splitting Uniformity

2. Applications

- Fiber Sensor System
- Fiber Optic Gyro
- Aerospace and Military Application

3. Compliance

- Telcordia GR-1209-CORE-2001
- Telcordia GR-1221-CORE-1999
- YD/T 2000.1-2009
- RoHS

4. Specifications

Table 1 1×N PLC Splitter

Parameters	1×2	1×4	1×8	1×16	1×32	1×64
Operating Wavelength (nm)	1550					
Fiber Type	Polarization Maintaining fiber or customer specified					
Insertion Loss (dB)(P/S Grade)	3.8/4.0	7.1/7.3	10.2/10.5	13.5/13.7	16.5/16.9	20.5/21.0
Loss Uniformity (dB)	0.4	0.6	0.8	1.2	1.5	2
Return Loss (dB) (P/S Grade)	55/50	55/50	55/50	55/50	55/50	55/50
Extinction Ratio (dB)	21	21	21	20	20	19
Directivity (dB)	55	55	55	55	55	55
Temperature Stability(-40~85 °C) (dB)	0.4	0.4	0.4	0.5	0.5	0.5
Operating Temperature (°C)	-40~85					
Storage Temperature (°C)	-40~85					
Module Dimension (mm) (L×W×H)	100×80×10	100×80×10	100×80×10	120×80×18	140×115×18	140×115×18

Notes:

1. Specified without connectors.
2. Add an additional 0.15dB loss per connector.
3. Bring down 2.0dB extinction ratio per connector.

5. Ordering information

PM PLC Splitter Module

GPM	-	PMXXX	-	XX	-	XX	-	XX	-	X	X
		Splitter Type		Plastic Box Dimension		Fiber Type		Fiber Length		Input Connector	Output Connector
G		PM102=1X2		PL=140X115X18mm		09= Ø 0.9mm		10=1.0m		0=None	0=None
P = P L C splitter		PM104=1X4		PM=120X80X18mm		20= Ø 2.0mm		15=1.5m		1=FC/UPC	1=FC/UPC
M=Module		PM108=1X8		PS=100X80X10mm		30= Ø 3.0mm		20=2.0m		2=FC/APC	2=FC/APC
			MM=Mini Module					3=SC/UPC	3=SC/UPC
		PM164=1X64		XX=Customize						4=SC/APC	4=SC/APC
										5=LC/UPC	5=LC/UPC
										6=LC/APC	6=LC/APC
										X= customize	X= customize

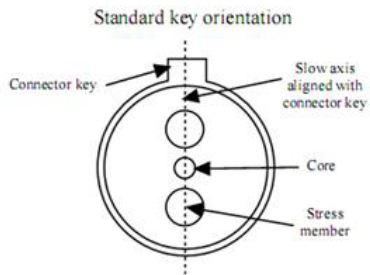

CWDM Mux/Demux Module

1. Features

- Low Insertion Loss
- High Isolation
- Low PDL
- Compact Design
- Good channel-to-channel uniformity
- Wide Operating Wavelength:
From 1260nm to 1620nm
- Wide Operating Temperature:
From -40°C to 85°C
- High Reliability and Stability



2. Applications

- CWDM System
- PON Networks
- CATV Links

3. Compliance

- Telcordia GR-1209-CORE-2001
- Telcordia GR-1221-CORE-1999
- RoHS

4. Specifications

1×N CWDM Mux/Demux Module

Parameters		1x2	1x4	1x8	1x16
Center Wavelength (nm)		ITU, ITU+1			
Passband (nm)		ITU±6.5			
Operating Wavelength (nm)		1460~1620 or 1260~1620			
Channel Space (nm)		20			
Fiber Type		SMF-28e or customer specified			
IL (dB) (P/A Grade)		0.7/1.0	1.4/1.7	2.0/2.5	3.5/4.0
Isolation (dB)	Adjacent Channel	30			
	Non-Adjacent Channel	50			
Ripple (dB)		0.3	0.4	0.5	0.5
PDL (dB)		0.2			
PMD (ps)		0.1			
RL (dB)		45			
Directivity (dB)		50			
Maximum Optical Power (mw)		500			

Operating Temperature (°C)	-40~85	
Storage Temperature (°C)	-40~85	
BOX Package (mm)	100*80*10	140*115*18
LGX Package	1U, 2U	
19" Rack mount Package	1U	

Notes:

1. Specified without connectors.
2. Add an additional 0.2dB loss per connector.

5. Ordering information

CWDM Mux/Demux Module

GWM	-	XX	X	X	XX	XX	XX	XX	-	X	X
		Port Configuration	WDM type	Module Type	Initial Wavelength	Package type	Fiber type	Output fiber length		Input	Output
G		01=1*1	C=CWDM 1460~1620	M=Mux	47=1470/1471	PL=140×115×18,plastic	09=0.9mm loose tube	10=1.0m		0=None	0=None
W=WDM		02=1*2	Q=CWDM 1260~1620	D=DEMUX	PM=120×80×18,plastic	20=2.0mm loose tube	12=1.2m		1=FC/UPC	1=FC/UPC
M=Module		X=100G DWDM	1=Mux&1310nm port	61=1610/1611	PS=100×80×10,plastic	30=3.0mm loose tube	15=1.5m		2=FC/APC	2=FC/APC
		16=1*6	Y=200G DWDM	2=Demux&1310nm port	21=21CH	LX=LG×box, mental		XX=Customized		3=SC/UPC	3=SC/UPC
				3=Mux&Upgrade	19=19' 1U Rack-Mount				4=SC/APC	4=SC/APC
				4=Demux&Upgrade	49=49CH	XX=Customized				5=LC/UPC	5=LC/UPC
				5=Mux&1310nm port&Upgrade						6=LC/APC	6=LC/APC
				6=Demux&1310nm port&Upgrade						X=Customized	X=Customized
				7=Mux1310nm port&Monitor							
				8=Demux&1310nm port&Monitor							

6. Mechanical Dimensions

CWDM Mux/Demux Module

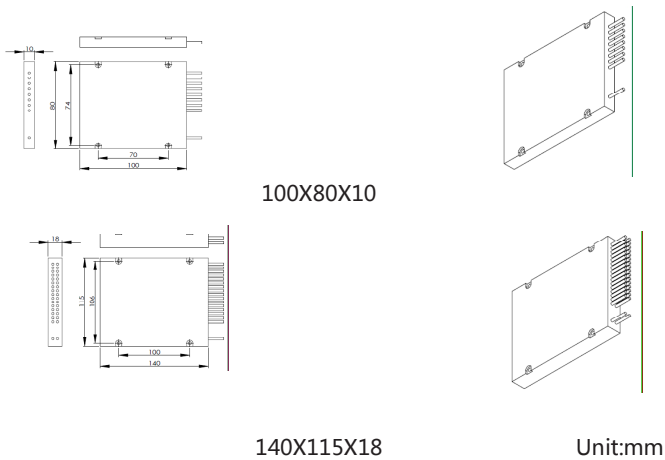

CWDM Optical Add/Drop Module

1. Features

- Low Insertion Loss
- High Isolation
- Low PDL
- Compact Design
- Good channel-to-channel uniformity
- Wide Operating Wavelength:
From 1260nm to 1620nm
- Wide Operating Temperature:
From -40°C to 85°C
- High Reliability and Stability



2. Applications

- CWDM System
- PON Networks
- CATV Links

3. Compliance

- Telcordia GR-1209-CORE-2001
- Telcordia GR-1221-CORE-1999
- RoHS

4. Specifications

NCH CWDM Optical Add/Drop Module

Parameters		1CH	2CH	4CH	8CH
Center Wavelength (nm)		ITU, ITU+1			
Passband (nm)		ITU±6.5			
Operating Wavelength (nm)		1460~1620 or 1260~1620			
Channel Space (nm)		20			
Fiber Type		SMF-28e or customer specified			
IL(dB) (P/A Grade)	Add&Drop Channel	0.5/0.6	0.7/1.0	1.4/1.7	2.0/2.5
	Express Channel	0.6/0.8	1.2/1.4	1.8/2.0	3.6/3.8
Isolation(dB)	Add&Drop Adjacent Channel	30			
	Add&Drop Non-Adjacent Channel	50			
	Express Channel	25			

Ripple(dB)	0.3	0.3	0.4	0.5
PDL(dB)	0.1			
PMD(ps)	0.1			
RL(dB)	45			
Directivity(dB)	50			
Maximum Optical Power (mw)	500			
Operating Temperature (°C)	-40~85			
Storage Temperature (°C)	-40~85			
BOX Package(mm)	100*80*10			140*115*18
LGX Package	1U, 2U			
19' Rack mount Package	1U			

Notes:

1. Specified without connectors.
2. Add an additional 0.2dB loss per connector.

5. Ordering information

CWDM Optical Add/Drop Module

GADM	-	X	XX	XX	XX	XX	-	X	X	X
		Channel Number	Initial Wavelength	Modules Type	Fiber type	Fiber length		Input connector	Add/Drop port connector	Express port connector
G		1=1CH	47=1470	PL=140×115×18, plastic	09=0.9mm loose tube	10=1.0m		0=None	0=None	0=None
AD=Optical Add/Drop		2=2CH	55=1550	PM=120×80×18, plastic	20=2.0mm loose tube	12=1.2m		1=FC/UPC	1=FC/UPC	1=FC/UPC
M=Module		4=4CH		PS=100×80×10, plastic	30=3.0mm loose tube	15=1.5m		2=FC/APC	2=FC/APC	2=FC/APC
		8=8CH		LX=LG×box, metal		XX= Customized		3=SC/UPC	3=SC/UPC	3=SC/UPC
				19=19' 1U Rack-Mount				4=SC/APC	4=SC/APC	4=SC/APC
				XX=Customized				5=LC/UPC	5=LC/UPC	5=LC/UPC
								6=LC/APC	6=LC/APC	6=LC/APC
								X= Customized	X=Customized	X=Customized

High-Isolation Filter Wavelength Division Multiplexing

1. Features

- Low Insertion Loss
- High Tx&Rx Isolation
- Low PDL
- Compact Design
- Good channel-to-channel uniformity
- Wide Operating Wavelength:
From 1260nm to 1620nm
- Wide Operating Temperature:
From -40°C to 85°C
- High Reliability and Stability



2. Applications

- CWDM System
- PON Networks
- CATV Links

3. Compliance

- Telcordia GR-1209-CORE
- Telcordia GR-1221-CORE
- RoHS

4. Specifications

1×2 FWDM Device

Parameters	Specification
Pass Band (nm)	1550+/-40
Reflection Band (nm)	1310+/-40
Pass Channel Insertion Loss @PB (nm)	<0.8
Reflection Channel Insertion Loss @RB (nm)	<0.6
Pass Channel Isolation @RB (dB)	>35
Reflection Channel Isolation @PB (dB)	>35
Ripple	<0.3
PDL (dB)	0.1
PMD (ps)	0.1
RL (dB)	45
Directivity (dB)	50
Fiber Type	Corning SMF-28e
Maximum Optical Power (mw)	500
Operating Temperature (°C)	-40~85
Storage Temperature (°C)	-40~85
Package Dimension (mm) (Φ×L)	Φ5.5*L34 250um Fiber Φ5.5*L38 900um Fiber

Notes:

1. Specified without connectors.
2. Add an additional 0.2dB loss per connector.

DWDM Mux/Demux Module

1. Features

- Low Insertion Loss
- High Isolation
- Low PDL
- Compact Design
- Good channel-to-channel uniformity
- Wide Operating Wavelength:
From 1460nm to 1620nm
- Wide Operating Temperature:
From -40°C to 85°C
- High Reliability and Stability

2. Applications

- DWDM System
- PON Networks
- CATV Links

3. Compliance

- Telcordia GR-1209-CORE-2001
- Telcordia GR-1221-CORE-1999
- ITU-T G.694.1
- RoHS

4. Specifications

1×N DWDM Mux/Demux Module



Parameters		Values					
Channel Space (GHz)		100			200		
Channel Number		1*4	1*8	1*16	1*4	1*8	1*16
Center Wavelength (nm)		ITU Grid					
Channel Passband (@-0.5dB) (nm)		0.22			0.5		
Fiber Type		SMF-28e with 900um loose tube or customer specified					
IL (dB)		1.8	3.0	4.0	1.7	2.9	3.8
Passband Ripple (dB)		0.35	0.4	0.5	0.35	0.4	0.5
Isolation (dB)	Adjacent Channel	25			28		
	Non-Adjacent Channel	40					
PDL (dB)		0.2					
PMD (ps)		0.1					
RL (dB)		45					
Directivity (dB)		50					

Maximum Optical Power (mw)	300
Operating Temperature (°C)	-40~85
Storage Temperature (°C)	-40~85
BOX Package (mm)	100*80*10 or 140*115*18
LGX Package	1U,2U
19' Rack mount Package	1U

Notes:

1. Specified without connectors.
2. Add an additional 0.2dB loss per connector.

5. Ordering information

GWM	-	XX	X	X	XX	XX	XX	XX	-	X	X
		Port Configuration	WDM type	Module Type	Initial Wavelength	Package type	Fiber type	Output fiber length		Input	Output
G		01=1*1	C=CWDM 1460~1620	M=Mux	47=1470/1471	PL=140×115×18,plastic	09=0.9mm loose tube	10=1.0m		0=None	0=None
W=WDM		02=1*2	Q=CWDM 1260~1620	D=DEMUX	PM=120×80×18,plastic	20=2.0mm loose tube	12=1.2m		1=FC/UPC	1=FC/UPC
M=Module		X=100G DWDM	1=Mux&1310nm port	61=1610/1611	PS=100×80×10,plastic	30=3.0mm loose tube	15=1.5m		2=FC/APC	2=FC/APC
		16=1*6	Y=200G DWDM	2=Demux&1310nm port	21=21CH	LX=LG×box, mental		XX=Customized		3=SC/UPC	3=SC/UPC
				3=Mux&Upgrade	19=19' 1U Rack-Mount				4=SC/APC	4=SC/APC
				4=Demux&Upgrade	49=49CH	XX=Customized				5=LC/UPC	5=LC/UPC
				5=Mux&1310nm port&Upgrade						6=LC/APC	6=LC/APC
				6=Demux&1310nm port&Upgrade						X=Customized	X=Customized
				7=Mux1310nm port&Monitor							
				8=Demux&1310nm port&Monitor							

6.Mechanical Dimensions

DWDM Mux/Demux Module

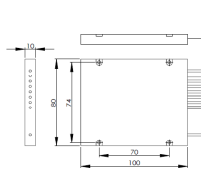

100X80X10

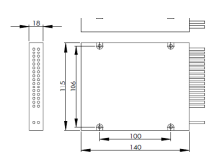
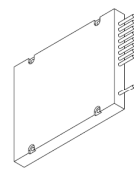

140X115X18

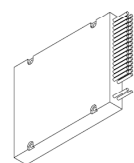

Unit:mm

100G DWDM Optical Add/Drop Module

1. Features

- Low Insertion Loss
- High Isolation
- Low PDL
- Compact Design
- Good channel-to-channel uniformity
- Wide Operating Wavelength:
From 1460nm to 1620nm
- Wide Operating Temperature:
From -40°C to 85°C
- High Reliability and Stability



2. Applications

- DWDM System
- PON Networks
- CATV Links

3. Compliance

- Telcordia GR-1209-CORE-2001
- Telcordia GR-1221-CORE-1999
- ITU-T G.694.1
- RoHS

4. Specifications

NCH DWDM Optical Add/Drop Module

Parameters		1CH	2CH	4CH	8CH
Center Wavelength (nm)		ITU			
Channel Passband (@-0.5dB) (nm)		ITU±0.11			
Operating Wavelength (nm)		1460~1620			
Channel Space (GHz)		100			
Fiber Type		SMF-28e or customer specified			
IL(dB)	Add&Drop Channel	1.0	1.5	1.8	3.0
	Express Channel	1.2	1.7	2.5	4.0
Isolation(dB)	Add&Drop Adjacent Channel	25			
	Add&Drop Non-Adjacent Channel	40			
	Express Channel	13			
Ripple(dB)		0.3	0.3	0.4	0.5
PDL(dB)		0.2			
PMD(ps)		0.1			
RL(dB)		45			
Directivity(dB)		50			
Maximum Optical Power (mw)		300			
Operating Temperature (°C)		-40~85			
Storage Temperature (°C)		-40~85			
BOX Package(mm)		100*80*10			140*115*18
LGX Package		1U, 2U			
19" Rack mount Package		1U			

Notes:

1. Specified without connectors.
2. Add an additional 0.2dB loss per connector.

Polarization Insensitive Fiber Isolator

1. Features

- Low Insertion Loss
- High Isolation
- Low PDL
- Compact Design
- Wide Operating Wavelength
- Wide Operating Temperature
- High Reliability and Stability



2. Applications

- CWDM System
- PON Networks
- CATV Links
- Fiber-optics Instruments
- Transmitters & Fiber Laser

3. Compliance

- Telcordia GR-1209-CORE-2001
- Telcordia GR-1221-CORE-1999
- RoHS

4. Specifications

Polarization Insensitive Fiber Isolator

Parameters		Single Stage		Dual Stage	
Grade		P	A	P	A
Central Wavelength (nm)		1550			
Minimum Isolation (@25°C, CW±15nm) (dB)		32	30	46	45
Insertion loss (dB)	Typ.	0.35	0.40	0.40	0.50
	Max.	0.40	0.50	0.50	0.60
PDL (dB)		0.05	0.10	0.05	0.10
PMD (ps)		0.20		0.07	
RL (dB)		55/55			
Maximum Optical Power (mw)		500			
Operating Temperature (°C)		-40~85			
Storage Temperature (°C)		-40~85			
Package Dimension (mm) (Φ×L)		Φ5.5*L34			

Notes:

1. Specified without connectors.
2. Add an additional 0.2dB loss per connector.
3. 1310, 1480, 1590 are optional.

Polarization Sensitive Free Space Isolator

1. Features

- High Isolation & Low Insertion
- Polarization Dependent
- Compact Size
- Exceptional reliability and stability
- Wide operating temperature range
- RoHS Compliant



2. Applications

- Laser Diode Packaging
- Optical Transmitter

3. Compliance

- Telcordia GR-1209-CORE-2001
- Telcordia GR-1221-CORE-1999
- RoHS

4. Specifications

Polarization Sensitive Free Space Isolator

Parameters	Single Stage		Dual Stage	
	P	A	P	A
Grade	P	A	P	A
Central Wavelength (nm)	1310/1490/1550			
Minimum Isolation (@25°C, CW±15nm) (dB)	32	30	45	45
Insertion loss (dB)	0.20	0.25	0.30	0.35
Clear Aperture (mm)	≥0.7			
Maximum Optical Power (mw)	500			
Operating Temperature (°C)	-40~85			
Storage Temperature (°C)	-40~85			
Package Dimension (mm) (Φ×L)	Φ2.5×1.4/Φ2.5×1.1			

5. Ordering information

FSI.	X	X	XX	X	XX
F=Free	Product type	Grade	Central Wavelength	Aperture	Size
S=Space	S=Single stage	P	31=1310	1=0.7mm	01=Φ2.5×1.1
I=Isolator	D=Dual stage	A	49=1490	2=0.8mm	02=Φ2.5×1.4
			55=1550	3=0.9mm	03=Other
			XX=Other	4=Other	

WDM-Isolator Hybrid (Hybrid)

1. Features

- Low Insertion Loss
- High Isolation
- Low PDL
- Compact Design
- Wide Operating Wavelength
- Wide Operating Temperature
- High Reliability and Stability

2. Applications

- CWDM System
- PON Networks
- CATV Links

3. Compliance

- Telcordia GR-1209-CORE
- Telcordia GR-1221-CORE
- RoHS

4. Specifications

WDM-Isolator Hybrid

Parameters		Values
Signal channel wavelength range (λ_s) (nm)		1550+/-20
Pump channel wavelength range (λ_p) (nm)		1480+/-20
Signal channel isolation (dB)	@ λ_p	30
	@ λ_s Signal channel→COM	30
Pump channel isolation (dB)		15
Insertion loss (dB)	Pump channel	0.4
	Signal channel	0.7
Ripple (dB)		0.3
PDL (dB)		0.1
PMD (ps)		0.1
RL (dB)		45
Directivity (dB)		50
Maximum Optical Power (mw)		500
Operating Temperature (°C)		-40~85
Storage Temperature (°C)		-40~85
Package Dimension (mm) ($\Phi \times L$)		$\Phi 5.5 \times L38$

Notes:

1. Specified without connectors.
2. Add an additional 0.2dB loss per connector.



Mechanical Variable Optical Attenuator (MVOA)

1. Features

- Low Insertion Loss
- High Precision
- Wide Attenuation range :
From 1260nm to 1620nm
- Compact Design
From 1260nm to 1620nm
- Wide Operating Temperature:
From -40°C to 85°C

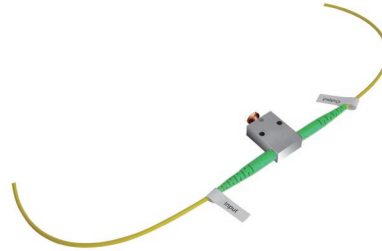

2. Applications

- Fiber Communication on system test
- Optical Passive component test
- Optics lab use

3. Compliance

- Telcordia GR-1209-CORE-2001
- Telcordia GR-1221-CORE-1999
- RoHS

4. Specifications

1×1 Mechanical Variable Optical Attenuator

Parameters	Values	
Operating wavelength (nm)	1260~1620	850/1310
Attenuation range (dB)	0.6~60	0.8~40
Original loss (dB)	0.6	0.8
Adjustment Precision (dB)	0.02	
PDL (dB)	0.15	
Fiber Type	SMF-28e	50/125 Or 62.5/125 Multi-Mode
Maximum Optical Power (mw)	500	
Operating Temperature (°C)	-40~85	
Storage Temperature (°C)	-40~85	
Dimension (mm)	26x18x8	

Notes:

1. Specified without connectors.
2. Add an additional 0.2dB loss per connector.

In-line Polarizer

1. Features:

- Low insertion loss
- High extinction ratio
- High Return Loss
- Excellent environmental stability and reliability

2. Applications:

- Fiber Laser
- Fiber Sensor
- Communication System
- Test Instrumentations
- Polarization maintaining optical system

3. Compliance:

- Telcordia GR-1209-CORE
- Telcordia GR-1221-CORE
- RoHS

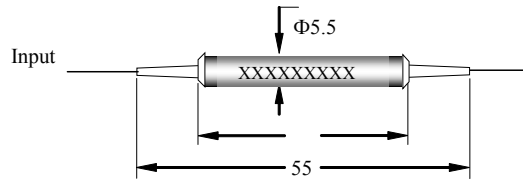

Unit:mm



4. Specifications:

Parameter	Unit	Values	
Operating wavelength	nm	1060±30	1310±40, 1550±40
Typ. Insertion Loss at 23℃	dB	≤0.4	≤0.3
Insertion Loss at -5℃~50℃	dB	≤0.7	≤0.5
Typ. Extinction Ratio	dB	30	30
Extinction Ratio	dB	≥28	≥28
Return Loss (Input/Output)	dB	≥50/50	≥50/50
Fiber type (Input-output)	—	Option1: PM980-PM980 Option2: HI1060-PM980 Option3: HI1060-HI1060	Option1: PMF-PMF Option2: SMF-28e-PMF Option3: SMF-28e - SMF-28e
Operating temperature	℃	-5~70	-5~70
Storage temperature	℃	-40~85	-40~85
Input power	mw	≤300	≤300
Dimensions	mm	Φ5.5×L34	Φ5.5×L34

*The specifications are w/o connector.

* For devices with connectors, 0.3dB higher for IL, 5dB lower for RL and 2dB lower for ER.

* For device with connector, key aligned to slow axis.

5. Product Ordering information:

ILP-XXXX-X-X-XX/XXX-XX*XX

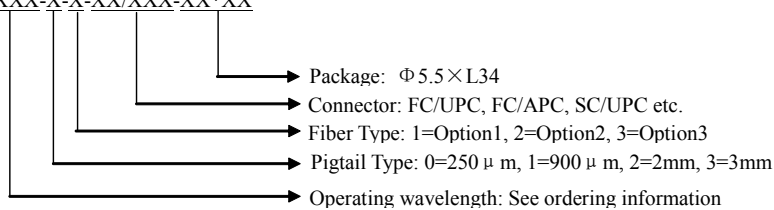

Polarization Beam Combiner/Splitter

1. Features:

- Low insertion loss
- High extinction ratio
- High Directivity
- Excellent environmental stability and reliability

2. Applications:

- Fiber Laser
- Fiber Sensor
- EDFA & Raman Amplifier
- PMD Compensator

3. Compliance:

- Telcordia GR-1209-CORE
- Telcordia GR-1221-CORE
- RoHS

4. Specifications:

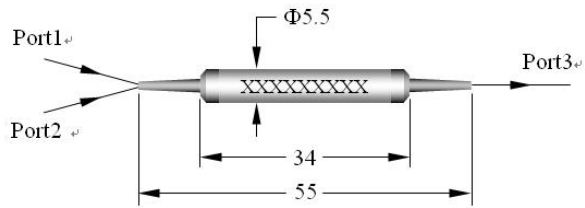

Unit:mm



Parameter	Type	Unit	Values							
			Grade P		Grade A		Grade P		Grade A	
Grade			Grade P	Grade A	Grade P	Grade A	Grade P	Grade A	Grade P	Grade A
Center Wavelength		nm	980 or 1060		1310,1480 or 1550		1260~1620nm			
Operating Wavelength Range		nm	±30		±40		-		-	
Typ. Insertion loss		dB	0.6	0.7	0.35	0.45	0.35	0.45	0.35	0.45
Insertion loss		dB	≤0.8	≤0.9	0.5	≤0.6	0.55	≤0.65	0.55	≤0.65
Return Loss		dB	≥50		≥50		≥50			
Extinction Ratio (for Splitter only)		dB	≥22	≥20	≥22	≥20	≥22	≥20	≥22	≥20
Directivity		dB	≥50		≥50		≥50			
Power Handling		mW	≤500		≤500		≤500			
Tensile Load		N	≤5		≤5		≤5			
Fiber Type (Port1&2)	/		SM98-PS-U25A		SM13-PS-U25A or SM15-PS-U25A		SM13-PS-U25A or SM15-PS-U25A			
Fiber Type (Port3)	/		See ordering information		See ordering information		See ordering information			
Operating Temperature		°C	-5 to +70		-5 to +70		-5 to +70			
Storage Temperature		°C	-40 to +85		-40 to +85		-40 to +85			

*The specifications are w/o connector.

* For devices with connectors, 0.3dB higher for IL, 5dB lower for RL and 2dB lower for ER.

* For device with connector, key aligned to slow axis.

5. Product ordering information:

PBC/S-1x2-X-XXXX-X-X-XX/XXX-XX*XX

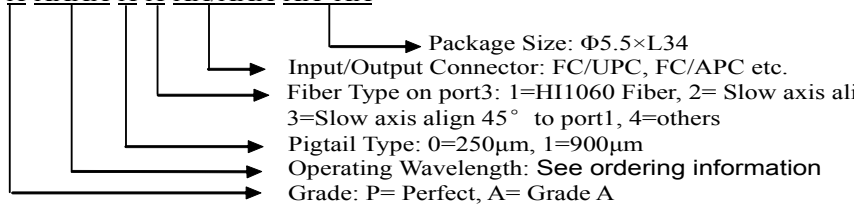

Polarization Maintaining Filter Coupler

1. Features:

- Low Insertion Loss
- High Extinction Ratio
- High Return Loss
- Excellent environmental stability and reliability

2. Applications:

- Fiber Laser
- Fiber Sensor
- Telecommunications
- Testing Systems

3. Compliance:

- Telcordia GR-1209-CORE
- Telcordia GR-1221-CORE
- RoHS

4. Specifications:

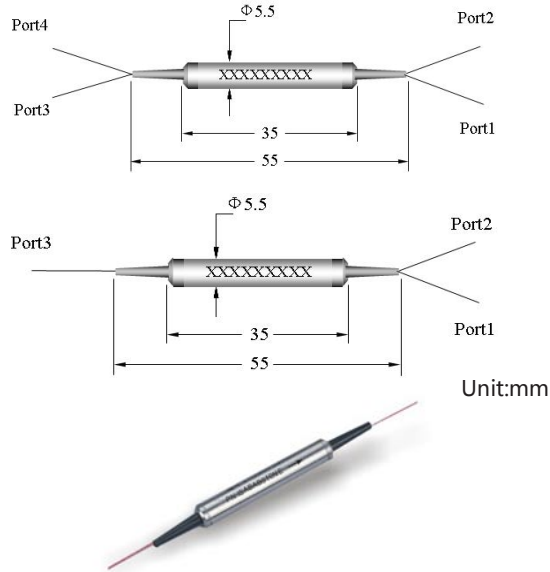

Parameters	Type	Unit	Values			
			1X2	2X2	1X2	2X2
Port Type			1X2	2X2	1X2	2X2
Operating Wavelength Range		nm	1064±20		1310±40 & 1550±40	
Excess Loss		dB	≤0.8	≤1.0	≤0.7	≤1.0
Uniformity (only for 50/50)		dB	≤0.6	≤0.8	≤0.5	≤0.7
Extinction Ratio for F type & (B type)		dB	≥22 & (20)	≥22 & (18)	≥22 & (20)	≥22 & (18)
Tap Ratio (Port 2/4)		%	1±0.2%, 2±0.4%, 5±1%, 10±2%, and 50%		1±0.2%, 2±0.4%, 5±1%, 10±2%, and 50%	
Return Loss		dB	≥50		≥50	
Handling Power		mW	≤500 (only for Splitter)		≤500 (only for Splitter)	
Tensile Load		N	≤5		≤5	
Fiber Type		-	SMF-28e or PM Panda Fiber on Tap Port		SMF-28e or PM Panda Fiber on Tap Port	
		-	PM Panda Fiber on input & Output Port		PM Panda Fiber on input & Output Port	
Operating Temperature		℃	-5 to +70		-5 to +70	
Storage Temperature		℃	-40 to +85		-40 to +85	
Light Path Explanation						
1x2	B Type		Port1 to Port2 & 3, Port2 is tap port.		Port1 to Port2 & 3, Port2 is tap port.	
	F Type		Port3 to Port1 & 2, Port2 is tap port.		Port3 to Port1 & 2, Port2 is tap port.	
2x2	B Type		Port1 to Port2 & 3, Port2 is tap port. Port3 to Port1 & 4, Port4 is tap port.		Port1 to Port2 & 3, Port2 is tap port. Port3 to Port1 & 4, Port4 is tap port.	
	F Type		Port1 to Port3 & 4, Port4 is tap port. Port3 to Port1 & 2, Port2 is tap port.		Port1 to Port3 & 4, Port4 is tap port. Port3 to Port1 & 2, Port2 is tap port.	
"B" for Both axis working, "F" for Fast axis blocking.						

*The specifications are w/o connector.

* For devices with connectors, 0.3dB higher for IL, 5dB lower for RL and 2dB lower for ER.

* For device with connector, key aligned to slow axis.

5. Product Ordering information:

PMFC-XXX-XXXX-XXXX-X-X-X-XX/XXX-XX

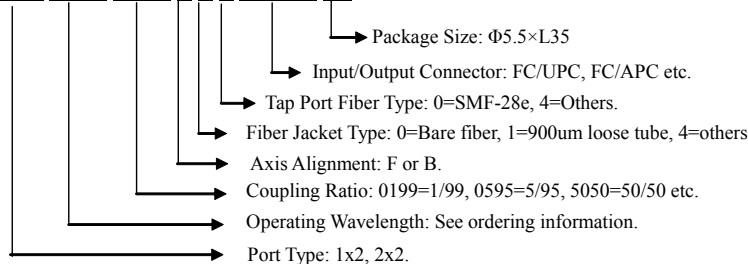

Polarization Maintaining Isolator

1. Features:

- High Isolation
- High Extinction Ratio
- Low Insertion Loss
- Excellent environmental stability and reliability

2. Applications:

- Fiber Laser
- Fiber Sensor
- Fiber Amplifiers
- Optical Transmitters & Transceivers

3. Compliance:

- Telcordia GR-1209-CORE
- Telcordia GR-1221-CORE
- RoHS

4. Specifications:

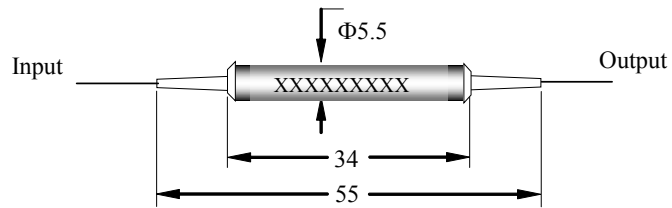

Unit:mm



Parameter \ Type	Single Stage		Dual Stage		Single Stage		Dual Stage	
	P	A	P	A	P	A	P	A
Operating wavelength (nm)	1064 ± 5				1310 ± 15 or 1550 ± 15			
Typ. Insertion Loss(dB)& 23℃	1.5	1.6	2.4	2.6	0.4	0.5	0.5	0.6
Insertion loss (dB) & -5℃~50℃	≤1.8	≤2.2	≤3.2	≤3.4	≤0.5	≤0.65	≤0.65	≤0.8
Typ. Peak isolation (dB)	40	38	55	52	42	40	58	55
Isolation at (dB) (23℃)	≥35	≥32	≥45	≥42	≥32	≥30	≥50	≥48
Extinction ratio Type B (dB)	≥20	≥18	≥20	≥18	≥22	≥20	≥22	≥20
Extinction ratio Type F (dB)	≥23	≥20	≥23	≥20	≥23	≥20	≥23	≥20
Return loss (input/output)	≥55/50	≥55/50	≥55/50	≥55/50	≥55/50	≥55/50	≥55/50	≥55/50
Fiber Type	SM98-PS-U25A				SM13-PS-U25A or SM15-PS-U25A			
Operating temperature (℃)	-5℃ ~ + 50℃				-5℃ ~ + 70℃			
Storage temperature (℃)	-40℃ ~ + 85℃				-40℃ ~ + 85℃			
Input power (mw)	≤300				≤500			
Dimensions (mm)	Φ5.5× L34				Φ5.5× L34			
“B” for Both axis working, “F” for Fast axis blocking.								

*The specifications are w/o connector.

* For devices with connectors, 0.3dB higher for IL, 5dB lower for RL and 2dB lower for ER.

* For device with connector, key aligned to slow axis.

5. Product Ordering information:

PMISO-X-X-X XXXX-X-X-XX/XXX-XX*XX

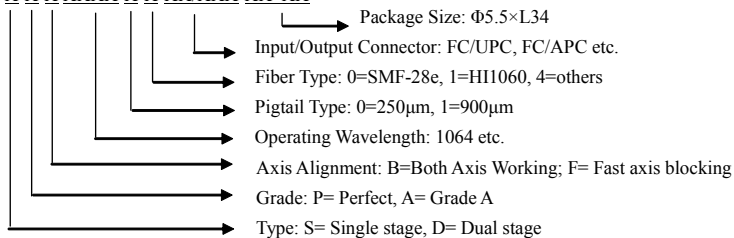

Polarization Maintaining Filter WDM-1X2

1. Features:

- Low Insertion Loss
- High Extinction Ratio
- Wide Pass Band
- Excellent environmental stability and reliability

2. Applications:

- Fiber Lasers
- Fiber Sensors
- Fiber Amplifiers

3. Compliance:

- Telcordia GR-1209-CORE
- Telcordia GR-1221-CORE
- RoHS

4. Specifications:

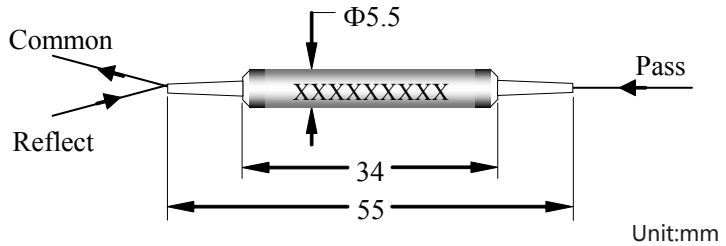

Parameter	Type	Units	Values		
Pass Band Wavelength Range		Nm	1530~1580	1550±10	1030~1080
IL over Pass Band		dB	≤0.7	≤0.7	≤0.8
Pass band Isolation@ 980+/-20nm		dB	≥30	≥30	≥25
Reflection Band Wavelength Range		Nm	980+/-20	1310±40&1490±10	960`990
IL over Reflection Band (Input2→Output)		dB	≤0.5	≤0.5	≤0.5
Reflection Band Isolation @ 1530~1580nm		dB	≥13	≥13	≥12
Extinct Ratio		dB	≥20	≥20	≥20
Optical Return Loss		dB	≥50	≥50	≥50
Power Handling (Max)		mW	≤500	≤500	≤300
Thermal Stability		dB/°C	≤0.005	≤0.005	≤0.005
Tensile Load		N	≤5	≤5	≤5
Operating Temperature Range		°C	-5 to 70	-5 to 70	-5 to 70
Storage Temperature Range		°C	-40 to 85	-40 to 85	-40 to 85
Fiber type		---	1550 Panda fiber, for Com and Pass 980 Panda&H11060 fiber for Reflect.	1550 Panda fiber or 1310 Panda fiber	PM 980 Panda Fiber
Fiber length		m	>0.75	---	---

*The specifications are w/o connector.

* For devices with connectors, 0.3dB higher for IL, 5dB lower for RL and 2dB lower for ER.

* For device with connector, key aligned to slow axis.

5. Product ordering information:

PMFWDM-1x2-XXXX-X-X-XX/XXX-XX*XX

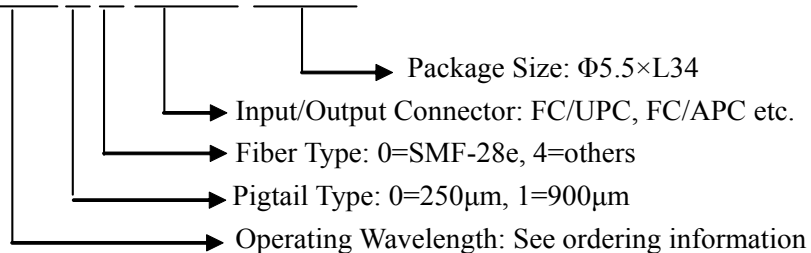

Polarization Maintaining Optical Circulator

1. Features:

- Low Insertion Loss
- High Extinction Ratio
- Excellent environmental stability and reliability

2. Applications:

- Fiber Optic instruments
- Fiber Sensors
- Coherent Detecting
- Research

3. Compliance:

- Telcordia GR-1209-CORE
- Telcordia GR-1221-CORE
- RoHS

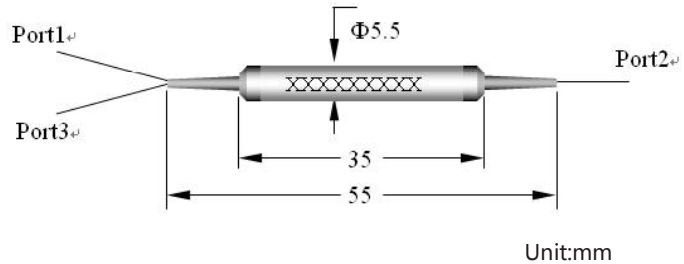

4. Specifications:

Parameter	Type	Unit	Values							
			Dual stage		Single stage		Dual stage		Single stage	
Port Type			1×2		2×2		1×2		2×2	
Center Wavelength		nm	1064±5		1064±5		1310±20 or 1550±20		1310±20 or 1550±20	
Typ. Insertion Loss		dB	3.0	1.8	3.2	2.2	0.7	0.5	0.8	0.7
Insertion Loss		dB	≤3.5	≤2.2	≤3.7	≤2.8	≤0.9	≤0.7	≤1.1	≤1.0
Peak Isolation		dB	45	38	45	35	52	40	55	40
Typ. Isolation		dB	40	30	40	28	46	35	50	30
Isolation		dB	≥35	≥22	≥35	≥20	≥40	≥28	≥40	≥20
Extinction Ratio		dB	≥22	≥20	≥20	≥20	≥22	≥20	≥20	≥20
Return Loss		dB	≥55	≥55	≥55		≥55	≥55	≥55	≥55
Cross Talk		dB	≥50		≥50		≥50		≥50	
Power Handling		mW	≤300		≤500		≤500		≤500	
Tensile Load		N	≤5		≤5		≤5		≤5	
Fiber Type			SM98-PS-U25A		SM13-PS-U25A or SM15-PS-U25A		SM13-PS-U25A or SM15-PS-U25A or SM15-PS-U25A		SM13-PS-U25A	
Operating Temperature		℃	-5 to +70		-5 to +70		-5 to +70		-5 to +70	
Storage Temperature		℃	-40 to +85		-40 to +85		-40 to +85		-40 to +85	

*The specifications are w/o connector.

* For devices with connectors, 0.3dB higher for IL, 5dB lower for RL and 2dB lower for ER.

* For device with connector, key aligned to slow axis.

5. Product ordering information:

PM CIR-1x2-X-XXXX-X-X-XX/XXX-XX*XX

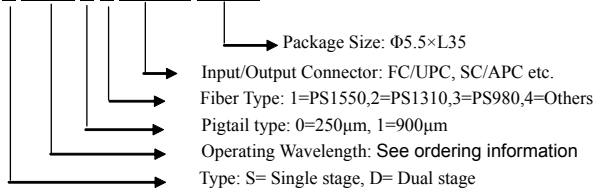

Polarization Maintaining Mechanical Variable Optical Attenuator

1. Features:

- Low Original Loss
- High Extinction Ratio
- Wide attenuation range
- Excellent environmental stability and reliability

2. Applications:

- Optical passive component test
- Optics lab use and research
- Fiber communication system test

3. Compliance:

- Telcordia GR-1209-CORE
- Telcordia GR-1221-CORE
- RoHS

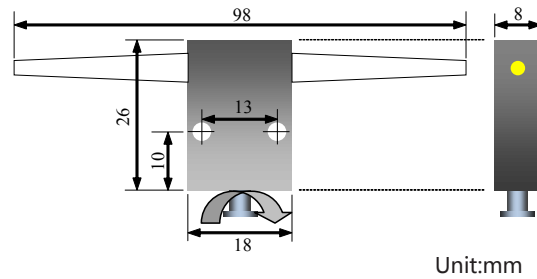
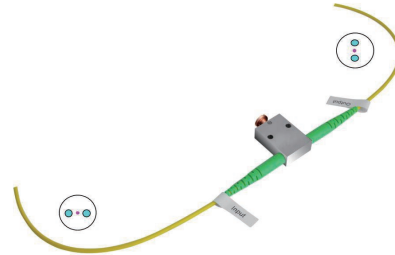

4. Specifications:

Parameter	Type	Unit	Values			
Center Wavelength		nm	1310 & 1550		980 & 1060	
Operating Wavelength Range		nm	±40		980±20 or 1060±30	
Max. Original loss		dB	0.5	0.6	0.6	0.7
Attenuation range		dB	0.5 ~ 60	0.6 ~ 50	0.6 ~ 60	0.7 ~ 50
Extinction Ratio (Typical)		dB	≥20 (22)		≥20 (22)	
Return Loss		dB	≥50		≥50	
Adjustment Precision		dB	0.02			
Power Handling		mW	≤500			
Tensile Load		N	≤5			
Fiber Type		/	SM98-PS-U25A, SM13-PS-U25A or SM15-PS-U25A			
Dimensions		mm	26× 18× 8			
Operating Temperature		°C	-5 to +70			
Storage Temperature		°C	-40 to +85			

*The specifications are w/o connector.

* For devices with connectors, 0.3dB higher for IL, 5dB lower for RL and 2dB lower for ER.

* For device with connector, key aligned to slow axis.

5. Product Ordering information:

PMMVOA-X-XXXX-X-X-XX/XXX-XX*XX

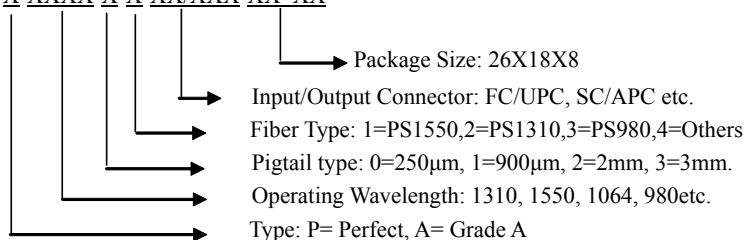

Polarization Maintaining Fiber Patch-cord

1. Features:

- High Return Loss
- High Extinction Ratio
- Low Insertion Loss
- Excellent environmental stability and reliability



2. Applications:

- Fiber Laser
- Fiber Instruments
- Fiber I/O Port
- Optical Transmitters & Transceivers

3. Compliance:

- Telcordia GR-1209-CORE
- Telcordia GR-1221-CORE
- RoHS

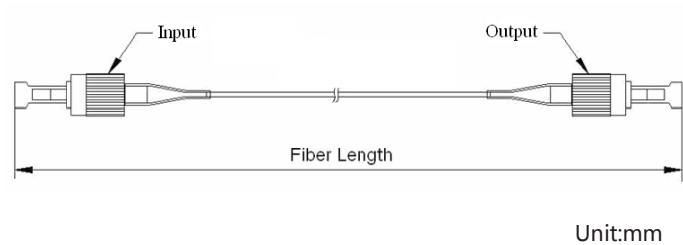

4. Specifications:

Parameter	Type			
	Values			
Single Mode Fiber				
Connector type	UPC		APC	
Operating wavelength (nm)	980, 1064, 1310, 1550			
Grade	P	A	P	A
Insertion loss (dB)	≤0.3	≤0.4	≤0.4	≤0.5
Extinction ratio (dB)	≥25	≥23	≥25	≥23
Return loss (dB)	≥55	≥50	≥65	≥60
Repeatability (dB)	≤0.1			
Changeability (dB)	≤0.2			
Durability (times)	≥1000			
Fiber Type	SM98-PS-U25A, SM13-PS-U25A or SM15-PS-U25A			
Storage temperature (°C)	-40°C ~ +85°C			

*The specifications are w/o connector.

* For devices with connectors, 0.3dB higher for IL, 5dB lower for RL and 2dB lower for ER.

* For device with connector, key aligned to slow axis.

5. Product Ordering information:

PMFP-X-X-X XXXX-X-X-XX*XX-XX*XX

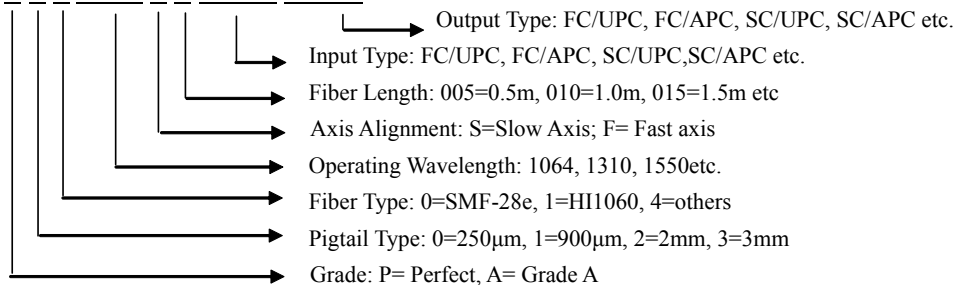

Polarization Maintaining Hybrid Device

Polarization Maintaining Isolator WDM-1X2(PMIWDM-T15/R98 & T15/R14)

1. Features:

- Low Insertion Loss
- High Extinction Ratio
- Wide Pass Band
- Excellent environmental stability and reliability

2. Applications:

- Fiber Lasers
- Fiber Sensors
- Fiber Amplifiers

3. Compliance:

- Telcordia GR-1209-CORE
- Telcordia GR-1221-CORE
- RoHS

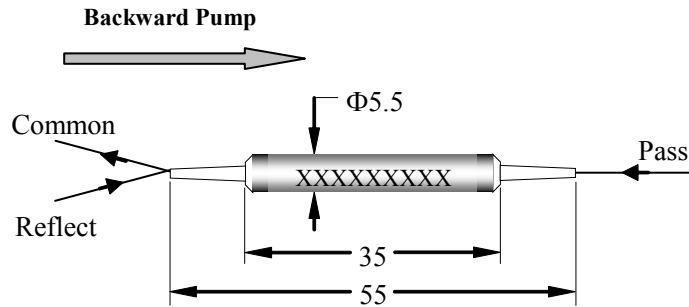

Unit:mm

4. Specifications:

Parameter	Type	Units	Values	
			Single Stage	Dual Stage
Signal Wavelength Range ($\lambda_c \pm 20\text{nm}$)		nm	1550 \pm 20	
IL over Pass Band@ λ_c (Typ.)		dB	≤ 1.0 (0.7)	≤ 1.1 (0.8)
Isolation @ ($\lambda_c \pm 15\text{nm}$) (Typ. Peek)		dB	≥ 30 (35)	≥ 48 (55)
Extinct Ratio@ λ_c for Type F(Type B)		dB	≥ 22 (20)	
Pump Wavelength Range		nm	980 \pm 20 & 1480 \pm 20	
IL over Reflection Band (Typ.)		dB	≤ 0.6 (0.35)	
Direction@ 980nm		dB	≥ 55	
Optical Return Loss		dB	≥ 50	
Thermal Stability		dB/°C	≤ 0.005	
Power Handling (Max)		mW	≤ 500	
Tensile Load		N	≤ 5	
Fiber type		---	1550 Panda fiber@Common & Pass 980 Panda, Hi1060 or SM-28e fiber @ Reflect	
Operating Temperature Range		°C	-5 to 70	
Storage Temperature Range		°C	-40 to 85	

"B" for Both axis working, "F" for Fast axis blocking

*The specifications are w/o connector.

* For devices with connectors, 0.3dB higher for IL, 5dB lower for RL and 2dB lower for ER.

* For device with connector, key aligned to slow axis.

5. Product ordering information:

PMIWDM-1X2-X-X-XXXX-X-X-XX/XXX-XX*XX

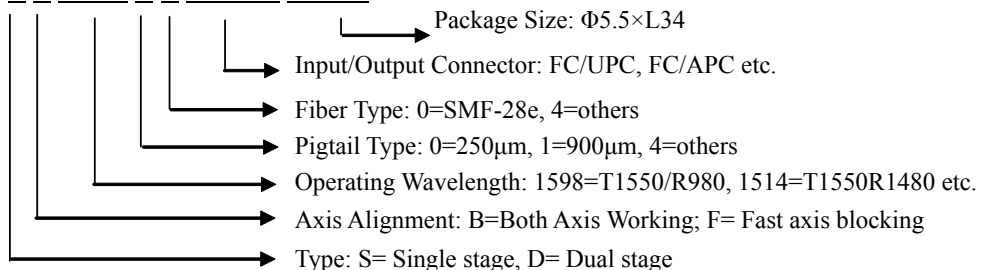

Polarization Maintaining Tap Isolator WDM

(PMTIWDM-2X2-T15R98 & T15R14)

1. Features:

- High Isolation
- High Extinction Ratio
- Low Insertion Loss
- Excellent stability and reliability

2. Applications:

- Fiber Laser
- Fiber Sensor
- Fiber Amplifiers
- Testing Systems

3. Compliance:

- Telcordia GR-1209-CORE
- Telcordia GR-1221-CORE
- RoHS

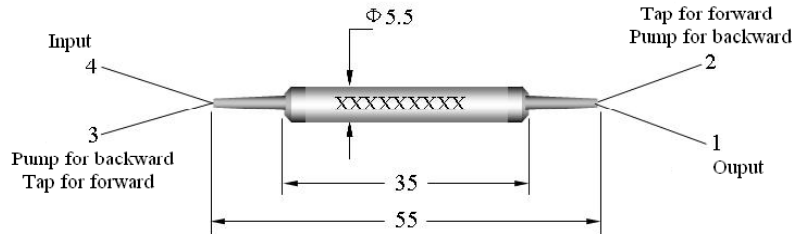

Unit:mm



4. Specifications:

Parameter	Type	Units	Values	
			Single Stage	Dual Stage
Signal Wavelength Range ($\lambda_c \pm 20\text{nm}$)		nm	1550 \pm 20	
Max.IL over Pass Band@ λ_c (input to output)		dB	1.1 (1%), 1.2 (2%), 1.3 (5%), 1.5 (10%), 4.2 (50%)	1.2 (1%), 1.3 (2%), 1.4 (5%), 1.6 (10%), 4.3 (50%)
Isolation @ ($\lambda_c \pm 15\text{nm}$) (Typ. Peek)		dB	≥ 30 (40)	≥ 48 (55)
Extinct Ratio@ λ_c for Type F(Type B)		dB	≥ 22 (20)	
Pump Wavelength Range		nm	980 \pm 20 & 1480 \pm 20	
IL over Reflection Band		dB	≤ 0.6	
Tap Ratio		%	1 \pm 0.2%, 2 \pm 0.4%, 4 \pm 0.8%, 5 \pm 1.0%, 10 \pm 2.0% and 50%	
Optical Return Loss		dB	≥ 50	
Thermal Stability		dB/°C	≤ 0.005	
Power Handling (Max)		mW	≤ 500	
Tensile Load		N	≤ 5	
Fiber type		---	1550 Panda fiber@ Input & Output, SM-28e fiber@ Tap, 980 Panda ,Hi1060 or SM-28e fiber @ Pump Port	
Operating Temperature Range		°C	-5 to 70	
Storage Temperature Range		°C	-40 to 85	

"B" for Both axis working, "F" for Fast axis blocking

*The specifications are w/o connector.

* For devices with connectors, 0.3dB higher for IL, 5dB lower for RL and 2dB lower for ER.

* For device with connector, key aligned to slow axis.

5. Product Ordering information:

PMTIWDM-1X2-X- X- XXXX-XXXX-X-X-XX/XXX-XX*XX

Package Size: $\Phi 5.5 \times L34$

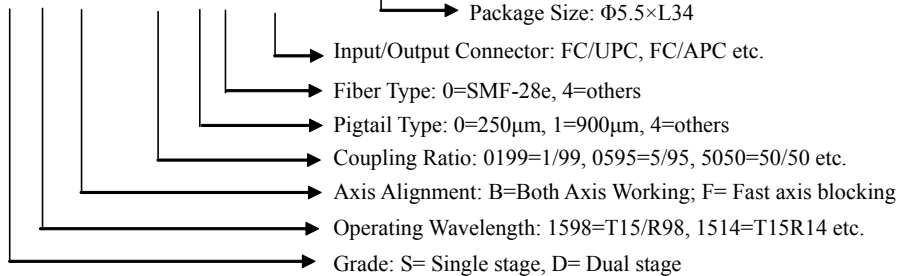

Polarization Maintaining Tap Isolator

(PMTAPI-1X2-1315)

1. Features:

- High Isolation
- High Extinction Ratio
- Low Insertion Loss
- Excellent environmental stability and reliability

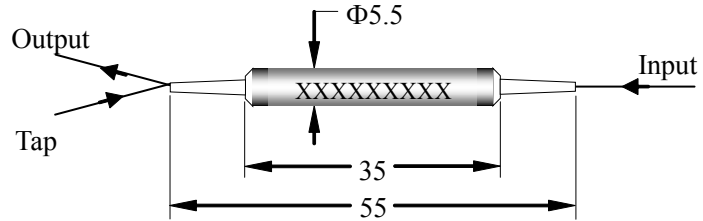

Unit:mm

2. Applications:

- Fiber Laser
- Fiber Sensor
- Fiber Amplifiers
- Testing Systems



3. Compliance:

- Telcordia GR-1209-CORE
- Telcordia GR-1221-CORE
- RoHS

4. Specifications:

Parameters	Type	Unit	Values	
			Single Stage	Dual Stage
Grade	-	-	Single Stage	Dual Stage
Operating Wavelength Range	-	nm	1550±20&1310±20	
Port Type	-	-	1X2	
Excess Loss	-	dB	≤0.8	≤0.9
Isolation@23℃	-	dB	≥30	≥45
Extinction Ratio (only for F type)	-	dB	≥22	≥22
Tap Ratio	-	%	1 ± 0.2%, 2 ± 0.4%, 4 ± 0.8%, 5 ± 1.0%, 10 ± 2.0% and 50%	
Return Loss	-	dB	≥50	
Handling Power	-	mW	≤500	
Tensile Load	-	N	≤5	
Fiber Type	-	-	SMF-28e or PM Panda Fiber on Tap Port	
	-	-	PM Panda Fiber on Input & Output Port	
Operating Temperature	-	℃	-5 to +70	
Storage Temperature	-	℃	-40 to +85	

“B” for Both axis working, “F” for Fast axis blocking.

*The specifications are w/o connector.

* For devices with connectors, 0.3dB higher for IL, 5dB lower for RL and 2dB lower for ER.

* For device with connector, key aligned to slow axis.

5. Product Ordering information:

PMTAPI-X-X-XX-XXXX-X-X-XX/XXX-XX*XX

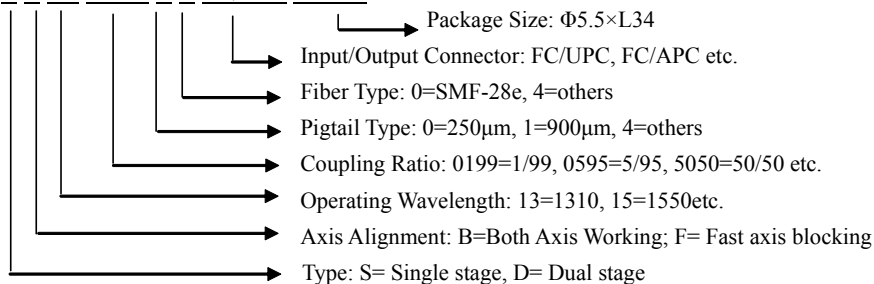

High Power Collimator

1. Features

- Low Insertion Loss
- High Power Handling
- Wide Operating Wavelength
- High Reliability and Stability

2. Applications

- Isolators
- Circulators
- Switches
- WDM

3. Compliance

- Telcordia GR-1209-CORE-2001
- Telcordia GR-1221-CORE-1999
- RoHS

4. Specifications

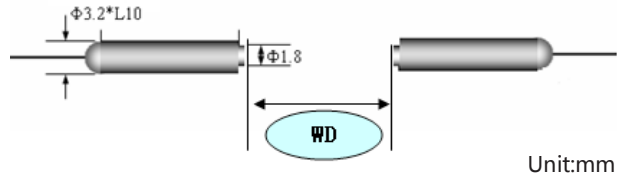

Parameters		Values		
		Standard		Long working distance
Working Distance (mm)		<20		<100
Grade		P	A	A
Insertion Loss($\lambda_c, 23^\circ\text{C}$) (dB) (λ_c @1310&1550nm)	Typ.	0.20	0.25	0.35
	Max.	0.25	0.30	0.40
Insertion Loss($\lambda_c, 23^\circ\text{C}$) (dB) (λ_c @980&1064nm)	Typ.	0.23	0.28	0.35
	Max.	0.28	0.35	0.45
Return Loss (dB)		60	55	
Housing Diameter(O.D.) (mm)		2.8 without metal tube		
		3.2 with metal tube		
Housing Length(L) (mm)		9 or10		
Fiber Type		SM-28e or HI1060		
Fiber Length (m)		1.5		
Input Power (w)&Continuous		1, 3, 5		
Operating Temperature ($^\circ\text{C}$)		-40~85		
Storage Temperature ($^\circ\text{C}$)		-40~85		

*The specifications are w/o connector.

* For devices with connectors, 0.3dB higher for IL, 5dB lower for RL and 2dB lower for ER.

* For device with connector, key aligned to slow axis.

5. Ordering information

HPCOLL-XXXX-X-X-XW-X-X-XX*XX

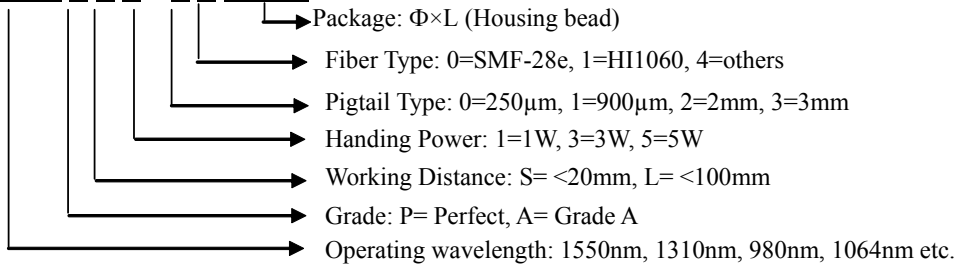

High Power Isolator 980&1064 nm

1. Features:

- High Power Handling
- High Isolation
- Low Insertion Loss
- Excellent environmental stability and reliability

2. Applications:

- Fiber Laser
- Fiber Sensor
- Fiber Amplifiers
- Optical Transmitters & Transceivers

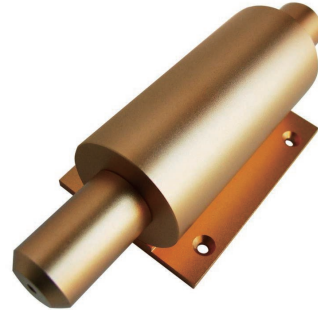

3. Specifications:

Parameter	Type	Specification (Grade P)	
Operating wavelength	nm	980 ± 10 / 1064 ± 10	
Typ. Insertion Loss & 23 °C	dB	0.8	
Insertion loss & 23 °C	dB	≤1.2	
Typ. Peak isolation	dB	30~40	
Isolation & 23 °C	dB	≥25	
Polarization Dependent Loss	dB	≤0.15	
Return loss (input/output)	dB	≥50/50	
Fiber Type	/	Hi1060	
Input power & Continuous	w	1, 3, 5,10 or Specify	
Operating temperature	°C	-5 ~ + 50	
Storage temperature	°C	-20 ~ + 75	
Dimensions	mm	126*50*34	

*The specifications are w/o connector.

* For devices with connectors, 0.3dB higher for IL, 5dB lower for RL and 2dB lower for ER.

* For device with connector, key aligned to slow axis.

4. Product Ordering information:

HPISO-X-X XXXX-X-X-XX/XXX-XX*XX

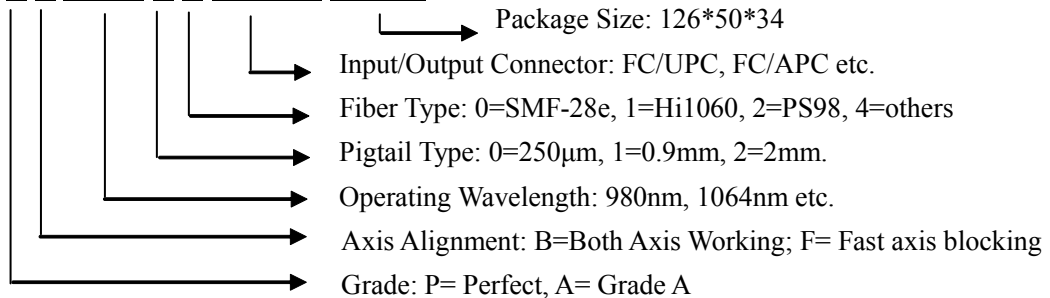

High Power Isolator 1310&1550 nm

1. Features:

- High Isolation
- High Power Handling
- Low Insertion Loss
- Excellent environmental stability and reliability

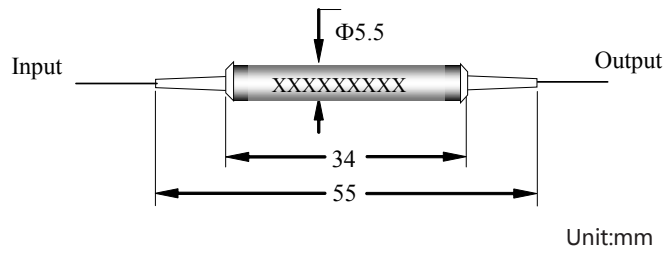

2. Applications:

- Fiber Laser
- Fiber Sensor
- Fiber Amplifiers
- Optical Transmitters & Transceivers

3. Compliance:

- Telcordia GR-1209-CORE
- Telcordia GR-1221-CORE
- RoHS



4. Specifications:

Parameter	Type	Single Stage		Dual Stage	
		P	A	P	A
Operating wavelength (nm)		1310 ± 15 or 1550 ± 15			
Typ. Insertion Loss(dB)& 23℃		0.45	0.55	0.60	0.70
Insertion loss (dB)& -5℃~50℃		≤0.55	≤0.70	≤0.80	≤1.0
Typ. Peak isolation (dB)		42	40	58	55
Isolation at (dB) (23℃)		≥32	≥30	≥50	≥48
Polarization Dependent Loss (dB)		≤0.05	≤0.10	≤0.05	≤0.10
Return loss (input/output)		≥55/50	≥55/50	≥55/50	≥55/50
Fiber Type		SMF-28e			
Operating temperature (℃)		-5℃ ~ +70℃			
Storage temperature (℃)		-40℃ ~ +85℃			
Input power (w) & Continuous		1, 3, 5			
Dimensions (mm)		Φ5.5×L34			

“B” for Both axis working, “F” for Fast axis blocking.

*The specifications are w/o connector.

* For devices with connectors, 0.3dB higher for IL, 5dB lower for RL and 2dB lower for ER.

* For device with connector, key aligned to slow axis.

5. Product Ordering information:

HPISO-X-X-X XXXX-X-X-XX/XXX-XX*XX

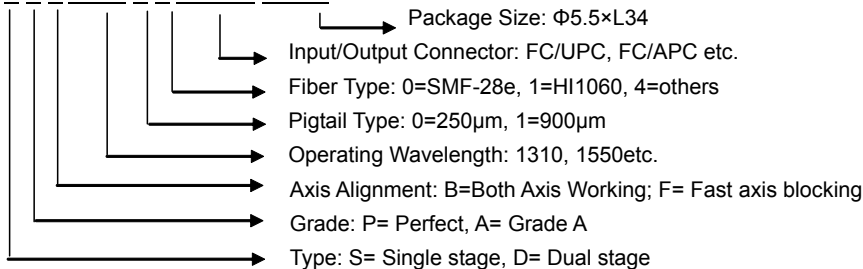

High Power Polarization Maintaining Isolator 1310&1550 nm

1. Features:

- High Isolation
- High Extinction Ratio
- Low Insertion Loss
- High Power Handling

2. Applications:

- Fiber Laser
- Fiber Sensor
- Fiber Amplifiers
- Optical Transmitters & Transceivers

3. Compliance:

- Telcordia GR-1209-CORE
- Telcordia GR-1221-CORE
- RoHS

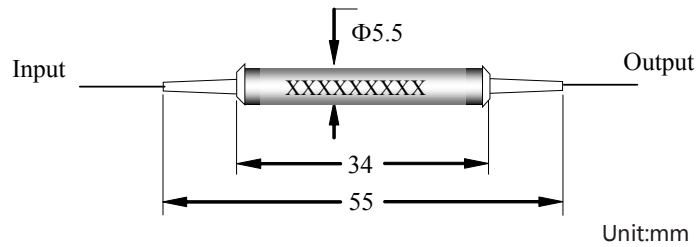

4. Specifications:

Parameter	Type	Single Stage		Dual Stage	
		P	A	P	A
Operating wavelength (nm)		1310 ± 15 or 1550 ± 15			
Typ. Insertion Loss(dB)& 23℃		0.45	0.55	0.60	0.70
Insertion loss (dB)& -5℃~50℃		≤0.55	≤0.70	≤0.80	≤1.0
Typ. Peak isolation (dB)		42	40	58	55
Isolation at (dB) (23℃)		≥32	≥30	≥50	≥48
Extinction ratio Type B (dB)		≥22	≥20	≥22	≥20
Extinction ratio Type F (dB)		≥23	≥20	≥23	≥20
Return loss (input/output)		≥55/50	≥55/50	≥55/50	≥55/50
Fiber Type		SM13-PS-U25A or SM15-PS-U25A			
Operating temperature (℃)		-5℃ ~ +70℃			
Storage temperature (℃)		-40℃ ~ +85℃			
Input power (w)		1, 3, 5			
Dimensions (mm)		Φ5.5×L34			
“B” for Both axis working, “F” for Fast axis blocking.					

*The specifications are w/o connector.

* For devices with connectors, 0.3dB higher for IL, 5dB lower for RL and 2dB lower for ER.

* For device with connector, key aligned to slow axis.

5. Product Ordering information:

HPPMI-X-X-X XXXX-X-X-XX/XXX-XX*XX

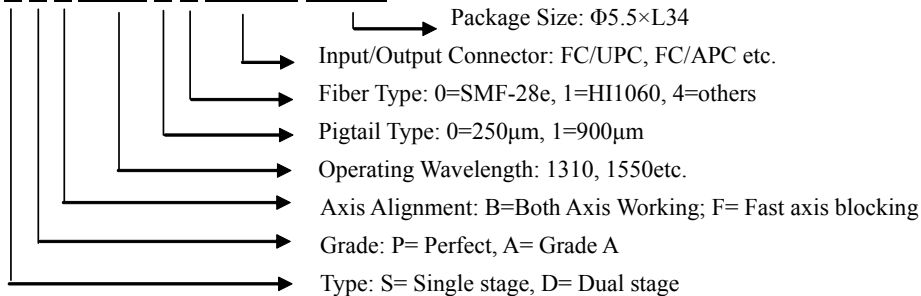

High Power Mechanical Variable Optical Attenuator

1. Features:

- Low Original Loss
- High Extinction Ratio
- Wide attenuation range
- Excellent environmental stability and reliability



2. Applications:

- Optical passive component test
- Optics lab use and research
- Fiber communication system test

3. Compliance:

- Telcordia GR-1209-CORE
- Telcordia GR-1221-CORE
- RoHS

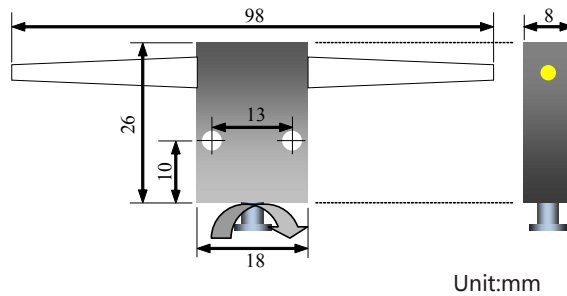

4. Specifications:

Parameter	Type	Unit	Values			
			P		A	
Center Wavelength		nm	1310 & 1550		980 & 1060	
Operating Wavelength Range		nm	±40		980±20 or 1060±30	
Max. Original loss		dB	0.5	0.6	0.6	0.7
Attenuation range		dB	0.5 ~ 60	0.6 ~ 50	0.6 ~ 60	0.7 ~ 50
Return Loss		dB	≥50		≥50	
Adjustment Precision		dB	0.02			
Power Handling (Continuous)		mW	500			
Tensile Load		N	≤5			
Fiber Type		/	SMF-28e			
Dimensions		mm	26×18×8			
Operating Temperature		℃	-5 to +70			
Storage Temperature		℃	-40 to +85			

*The specifications are w/o connector.

* For devices with connectors, 0.3dB higher for IL, 5dB lower for RL and 2dB lower for ER.

* For device with connector, key aligned to slow axis.

5. Product Ordering information:

MVOA-X-XXXX-X-X-XX/XXX-XX*XX

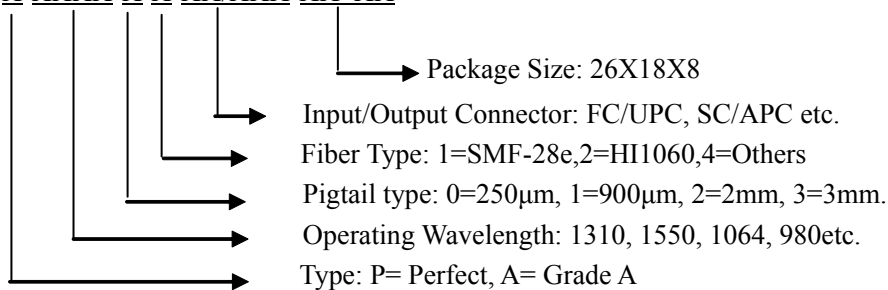

High Power Polarization Maintaining Mechanical VOA

1. Features:

- Low Original Loss
- High Extinction Ratio
- Wide attenuation range
- Excellent environmental stability and reliability

2. Applications:

- Optical passive component test
- Optics lab use and research
- Fiber communication system test

3. Compliance:

- Telcordia GR-1209-CORE
- Telcordia GR-1221-CORE
- RoHS

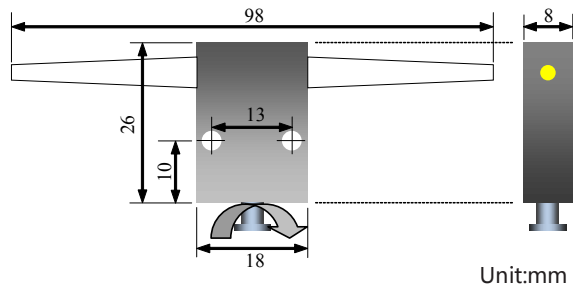
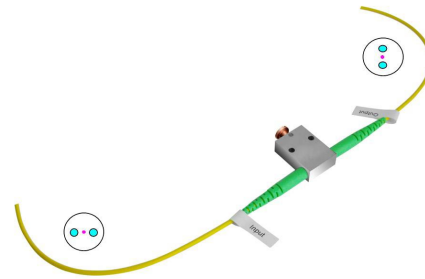

4. Specifications:

Parameter	Type	Unit	Values			
			P		A	
Center Wavelength		nm	1310 & 1550		980 & 1060	
Operating Wavelength Range		nm	±40		980±20 or 1060±30	
Max. Original loss		dB	0.5	0.6	0.6	0.7
Attenuation range		dB	0.5 ~ 60	0.6 ~ 50	0.6 ~ 60	0.7 ~ 50
Extinction Ratio(Typical)		dB	≥20 (22)		≥20 (22)	
Return Loss		dB	≥50		≥50	
Adjustment Precision		dB	0.02			
Power Handling (Continuous)		W	1, 3, 5, 10			
Tensile Load		N	≤5			
Fiber Type		/	SM98-PS-U25A, SM13-PS-U25A or SM15-PS-U25A			
Dimensions		mm	26× 18× 8			
Operating Temperature		℃	-5 to +70			
Storage Temperature		℃	-40 to +85			

*The specifications are w/o connector.

* For devices with connectors, 0.3dB higher for IL, 5dB lower for RL and 2dB lower for ER.

* For device with connector, key aligned to slow axis.

5. Product ordering information:

HPPMMVOA-X-XXXX-X-X-XX/XXX-XX*XX

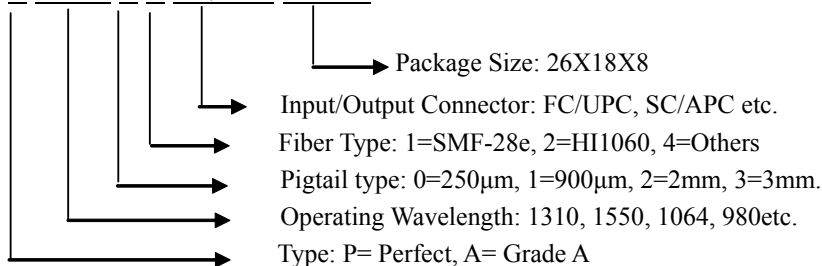

Single Mode Single Window Coupler

1. Features:

- Low excess loss
- Low PDL
- High stability and reliability
- Various coupling ratio

2. Applications:

- CATV
- Optical communication systems
- Testing instruments
- FTTH , FTTB



3. Specifications:

Parameter		P Grade	A Grade
Operating wavelength (nm)		1310, 1550, others on request	
Operating bandwidth (nm)		±40	
Insertion loss (dB)	50/50	≤3.40	≤3.60
	40/60	≤4.50/2.60	≤4.70/2.70
	30/70	≤5.70/1.90	≤6.00/1.90
	20/80	≤7.60/1.20	≤7.90/1.20
	10/90	≤11.00/0.65	≤11.30/0.65
	5/95	≤14.20/0.40	≤14.60/0.40
	2/98	≤18.40/0.25	≤18.80/0.30
	1/99	≤21.50/0.20	≤22.50/0.25
PDL (dB)		≤0.10	≤0.15
Directivity (dB)		≥50	
Operating temperature (℃)		-40 ~ +85	

4. Package Information:

Configuration	1×2 or 2×2		
Fiber lead length	1 meter, others on request		
Fiber type	250μm bare fiber	900μm loose tube	900μm/2mm/3mm loose tube
Dimensions (φ×L)	φ3.0mm×45mm	φ3.0mm×54mm	90mm×20mm×10mm
	φ3.0mm×54mm	φ3.0mm×60mm	

Single Mode Dual Window Coupler

1. Features:

- Low excess loss
- Low PDL
- High stability and reliability
- Various coupling ratio

2. Applications:

- CATV
- Optical communication systems
- Testing instruments
- FTTH, FTTB

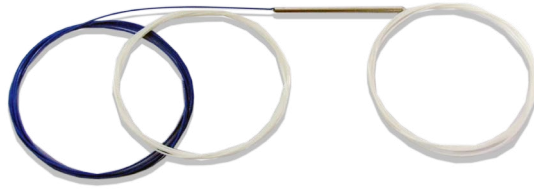

3. Specifications:

Parameter		P Grade	A Grade
Operating wavelength (nm)		1310 and 1550	
Operating bandwidth (nm)		±40	
Insertion loss (dB)	50/50	≤3.60	≤3.80
	40/60	≤4.70/2.70	≤4.90/2.90
	30/70	≤6.00/1.90	≤6.30/2.10
	20/80	≤7.90/1.20	≤8.40/1.40
	10/90	≤11.30/0.65	≤12.00/0.80
	5/95	≤14.60/0.40	≤15.50/0.50
	2/98	≤18.80/0.30	≤19.50/0.40
	1/99	≤22.50/0.25	≤23.50/0.35
PDL (dB)		≤0.15	≤0.20
Directivity (dB)		≥50	
Operating temperature (°C)		-40 ~ +85	

4. Package Information:

Configuration	1×2 or 2×2		
Fiber lead length	1 meter, others on request		
Fiber type	250μm bare fiber	900μm loose tube	900μm/2mm/3mm loose tube
Dimensions (φ×L)	φ3.0mm×45mm	φ3.0mm×54mm	90mm×20mm×10mm
	φ3.0mm×54mm	φ3.0mm×60mm	

Dual Window Coupler Module

1. Features:

- Low excess loss
- Low PDL
- High stability and reliability

2. Applications:

- CATV
- Optical communication systems
- Testing instruments
- FTTH, FTTB



3. Specifications:

Operating wavelength	nm	1310 and 1550			
Operating bandwidth	nm	±40			
Configuration		1(or2)'4	1(or2)'8	1(or2)'16	1(or2)'32
Typical Insertion loss	dB	6.30	9.50	12.70	15.90
Insertion loss	dB	7.00	10.60	14.10	17.70
Uniformity	dB	1.4	2.10	2.8	3.50
WDL	dB	0.80	1.20	1.60	2.00
PDL	dB	0.30	0.45	0.60	0.75
Thermal Stability	dB/°C	0.004	0.006	0.008	0.01
Directivity	dB	50			
Operating temperature	°C	-40 ~ +85			

4. Package Information:

Configuration	1×4 or 2×4	1×8 or 2×8	1×16 or 1×32
Fiber lead length	1 meter, others on request		
Fiber type	900µm/2mm/3mm loose tube		
Dimensions (L*W*H)	100×80×10	100×80×10	125×96×15

5. Ordering information:

GFC	XXX	XX	XX	X	XX	XX	XX	XX
	Port Configuration	Modules type	Coupling Ratio/ Attenuation (dB)	Grade	Fiber Length	Cable type	Wavelength	Input/Output connector
G F=Fused C=Coupler	102=1x2 202=2x4	A package B package C package D package E package	50=50/50 30=30/70 10=10/90 05=5/95 01=1/99	PS	10=1.0m 15=1.5m 20=2.0m	B=Bare Fiber 09=∅ 0.9 20=∅ 2.0 30=∅ 3.0	83=830nm 85=850nm 98=980nm 13=1310nm 14=1480nm 15=1550nm 16=1585nm	0=None 1=FC/PC 2=FC/APC 3=SC/PC 4=SC/APC 5=LC/PC 6=LC/APC X=Customized

Type:

M -- Multimode Fiber Coupler

PACKAGE DIMENSIONS & PIGTAIL STYLE

Package Dimensions:

Package A:

3mm x 54mm stainless steel tube



Package B:

3mm x 60mm stainless steel tube



Package C:

8.5mm x 14mm x 98mm case

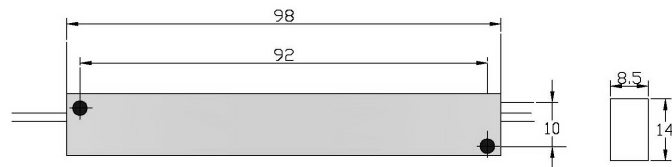

Package D:

11.6mm x 80mm x 120mm

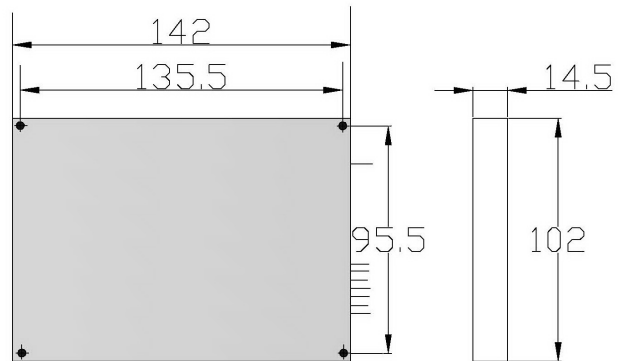

Package E:

14.5mm x 102mm x 142mm

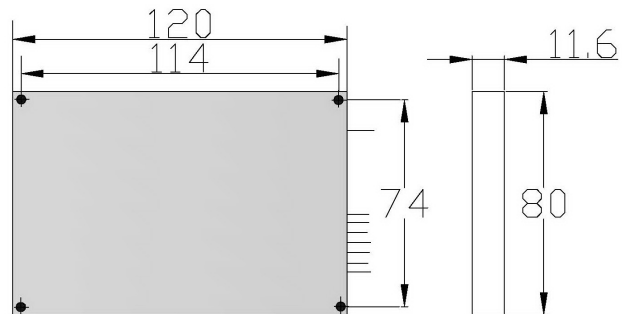

Unit:mm

Pigtail Style:

Package A: 250um bare fiber

Package B: 250um bare fiber or 900um loose tube

Package C ~ E: 3mm cable or 900um loose tube

MEMS Variable Optical Attenuator

1. Description

We design and manufacture innovative, photonic integrated circuit (PIC) based MEMS (micro electro-mechanical systems) Variable Optical Attenuator for next generation, dynamically configurable optical networks.

Our MEMS products are based on electrostatic MEMS technology. The reflective mirror MEMS technology enables the creation of products with high attenuation levels and can be configured as bright or dark devices. When combined with the advanced packaging and manufacturing capabilities, this results in a new category of MEMS components that are designed to exceed specifications for performance, compactness, manufacturability and reliability.

2. Features

- Low insertion loss
- Low polarization dependent loss
- Compact design
- Low power consumption
- Insensitive to shock and vibration

3. Applications

- Power control and equalization in multi channel systems
- Gain-tilt control in EDFAs
- Receiver protection
- Channel on/off switching
- OADM

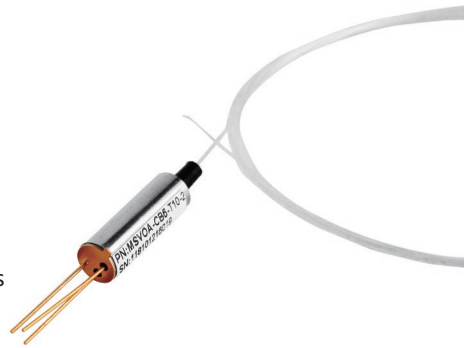

4. Compliance

- Telcordia GR-1221-CORE
- RoHS

5. Performance specifications

Parameter	Unit	Specification	Note
Wavelength Range	nm	1530 - 1570	C band
		1570 - 1610	L band
Attenuation Type		Bright or Dark	
Attenuation Range	dB	≥30	
Blocking State Attenuation	dB	≥40	Dark type
Insertion Loss	dB	≤0.7 (0.5 Typical)	Excluding Connectors
Attenuation Resolution		Continuous	
Wavelength Dependent Loss	dB	≤0.3	@<0dB Att.
		≤0.7	@<20dB Att.

Other Products

Ripple	dB	≤ 0.05	Within 0.4nm window @20dB
Polarization Dependent Loss	dB	≤ 0.1	@<0dB Att.
		≤ 0.3	@<20dB Att.
Temperature Dependent Loss	dB	≤ 0.7	@<0dB Att. compare with RT
		≤ 1.0	@<20dB Att. compare with RT
Return Loss	dB	≥ 45	
PMD	ps	≤ 0.1	
Response Time	ms	≤ 3	10-90% Optical Power
Optical Power Handling	mW	300	
Driving Voltage	VDC	6V or 15V	
Power Consumption	mW	≤ 2	
Operating Temperature	°C	0 to 70	
Storage Temperature Range	°C	-40 to 85	

6. Ordering information

MSVOA-	X	X-	XX-	X	XX-	X	X
MS=MEMS	Operating Wavelength	Attenuation Type	Drive Voltage	Fiber Type	Fiber Length	Connector Type	Connector Type
V=Variable	C=C Band	B=Bright	6=6V	B=250 μ m fiber	10=1.0m	0=None	0=None
O=Optical	L=L Band	D=Dark	15=15V	T=900 μ m fiber	15=1.5m	1=FC/UFC	1=FC/UFC
A=Attenuator						2=FC/APC	2=FC/APC
						3=SC/UPC	3=SC/UPC
						4=SC/APC	4=SC/APC
						5=LC/UPC	5=LC/UPC
						6=LC/APC	6=LC/APC

7. Dimensions diagram

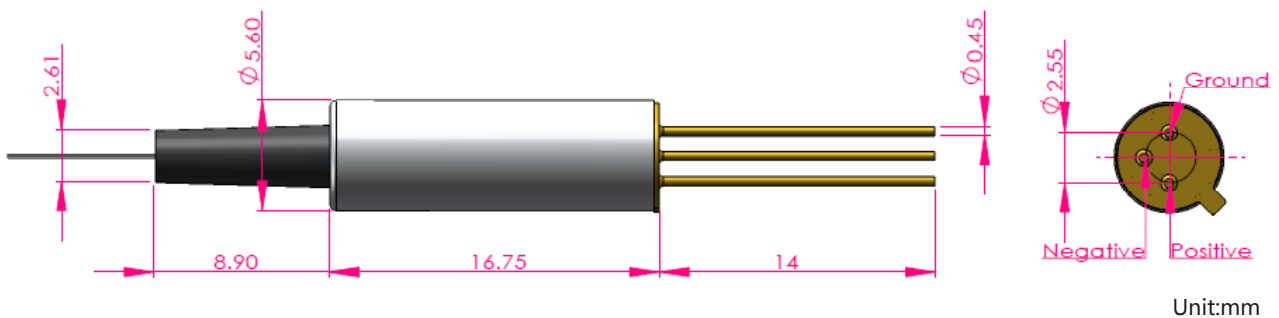

Faraday Rotator Mirror (FRM)

1. Features

- Low Insertion Loss
- Wide Operating Wavelength Range
- Compact Size
- Epoxy free on optical path
- Exceptional Stability and Reliability
- Wide Operating Temperature:
From -40°C to 85°C
- High Reliability and Stability



2. Applications

- Interference Sensor System

3. Compliance

- Telcordia GR-1209-CORE-2001
- Telcordia GR-1221-CORE-1999
- RoHS

4. Specifications

FRM Device

Parameters	
Center wavelength (nm)	1310&1550
Bandwidth (nm)	±15
Rotation Angle (degree)	45/90
Rotation Angle Tolerance Over Wavelength Range (degree)	±2
Fiber Type	SMF-28e
Fiber Length (m)	1.0
IL (dB)	0.5
TDL (dB)	0.25
PDL (dB)	0.1
Maximum Optical Power (mw)	500
Operating Temperature (°C)	-40~85
Storage Temperature (°C)	-40~85
Package Dimension (mm) (Φ×L)	Φ3.5*17

Notes:

1. Specified without connectors.
2. Add an additional 0.2dB loss per connector.

TAP Photo Detector

1. Description

Our Tap Photo Detector (Tap PD) is a hybrid device that integrates a thin-film tap collimator with a high sensitivity PIN photodiode. The products adopt a new design solution that offers very high responsivity, low dark current, compact size with wide band-width, high reliability and low cost.

We can provide customized designs to meet specialized feature applications. Also, we offer modular assemblies.

2. Features

- High responsivity
- Low dark current
- Low WDL and PDL
- Compact design
- Customized tap ratios available

3. Applications

- DWDM channel monitoring
- Optical line protection monitoring
- ROADM Multiplexers
- Gain monitoring in Amplifier

4. Compliance

- Telcordia GR-1221-CORE
- RoHS

5. Performance specifications

Parameter	Unit	Specification			Note
Wavelength Range	nm	1530 - 1570			C band
		1570 - 1610			L band
Tap ratio		1:99	3:97	5:95	
Maximum Input Power	dBm	25	22	18	
Responsibility	mA/W	7~12	14~24	40~60	
Insertion Loss	dB	0.5	0.5	0.6	Excluding Connectors
Wavelength Dependent Loss	dB	≤0.3			
Polarization Dependent Loss	dB	≤0.1			
Return Loss	dB	≥45			
Dark Current	nA	≤5.0 (1.0 Typical)			V _r =5V, 25°C
Reverse Voltage	V	≤20			
Forward Current	mA	≤10			
Capacitance	pF	≤8.0 (5.0 Typical)			V _r =5V, f=1MHz
Bandwidth	GHz	2			RL=50Ω, -3dB
Operating Temperature	°C	-5 to 70			
Storage Temperature Range	°C	-40 to 85			

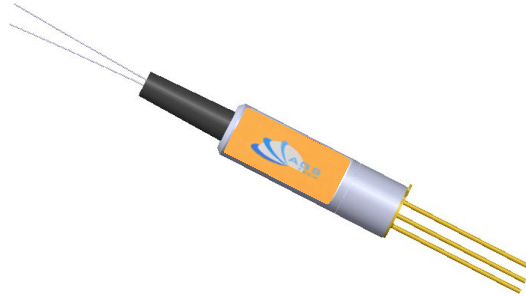

6. Ordering information

TaP PD-	X	XX-	X	XX-	X	X
	Operating Wavelength	Tap ratio	Fiber Type	Fiber Length	Connector Type	Connector Type
	C=C Band	01:1/99	B=250μm fiber	10=1.0m	0=None	0=None
	L=L Band	03:3/97	T=900μm fiber	15=1.5m	1=FC/UFC	1=FC/UFC
		05:5/95			2=FC/APC	2=FC/APC
					3=SC/UPC	3=SC/UPC
					4=SC/APC	4=SC/APC
					5=LC/UPC	5=LC/UPC
					6=LC/APC	6=LC/APC