



AGS-TECH Inc., Tel: 505-550-6501 and 505-565-5102, Fax: 505-814-5778,

Email: [sales@agstech.net](mailto:sales@agstech.net), Web: <http://www.agstech.net>

## MANUFACTURING OF TECHNICAL CERAMICS:

### Die Pressing

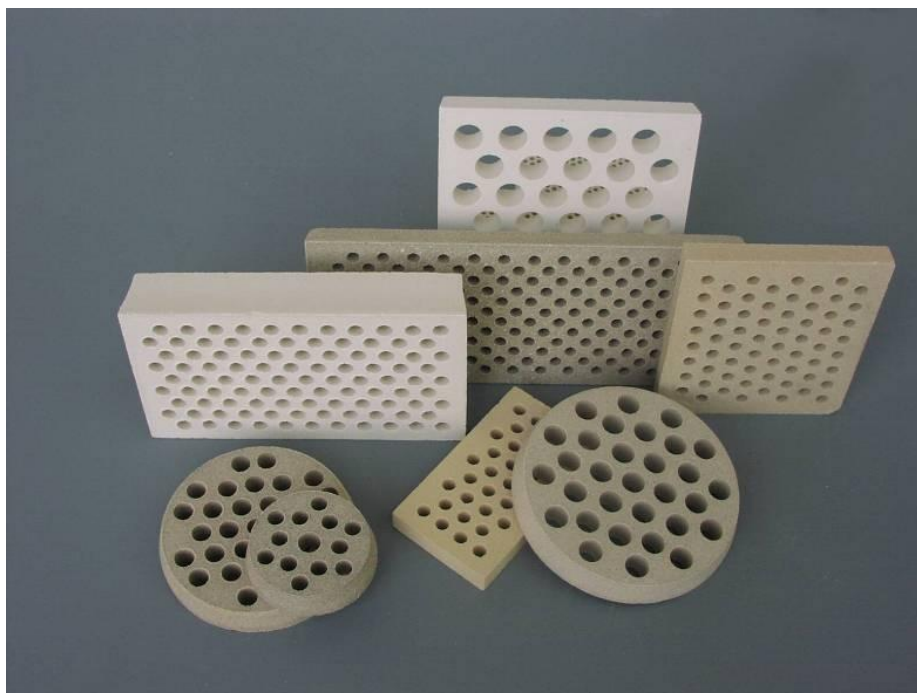
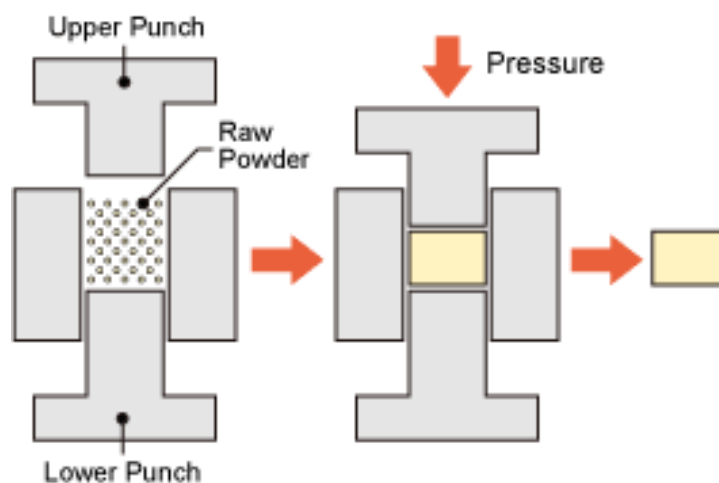

AGS-TECH Inc., Tel: 505-550-6501 and 505-565-5102, Fax: 505-814-5778, Email: [sales@agstech.net](mailto:sales@agstech.net), Web: <http://www.agstech.net>

### Hot Pressing

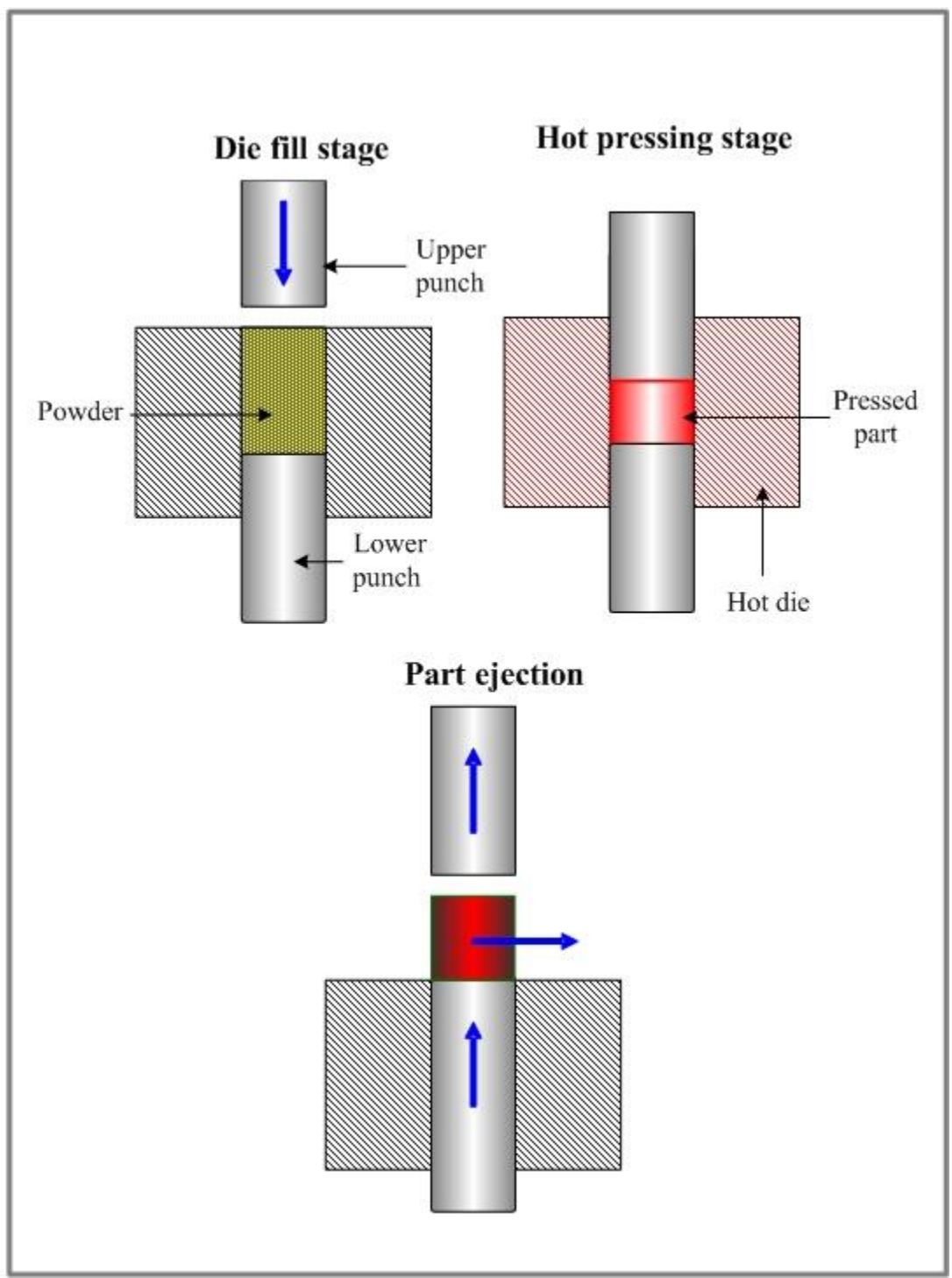

### Cold Isostatic Pressing

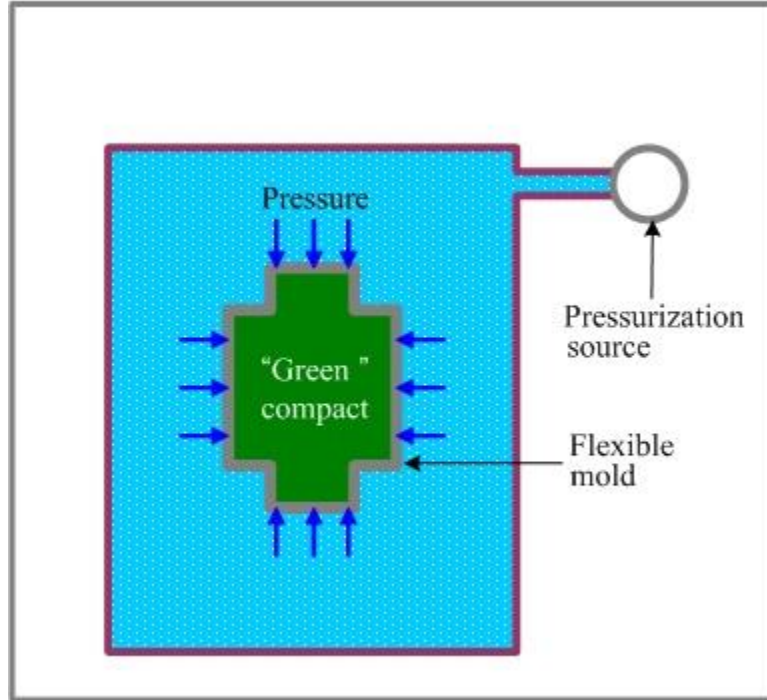

### Hot Isostatic Pressing

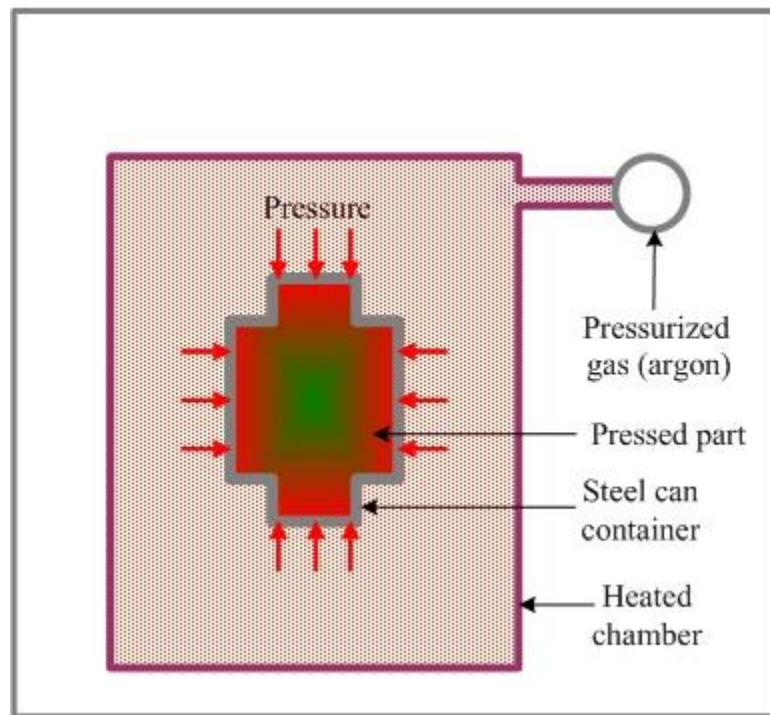



Production of 15-millimeter-diameter samples of transparent ceramic yttrium– aluminum–garnet. A sample exhibits excellent optical qualities after hot isostatic pressing (right).

## Slip Casting Process

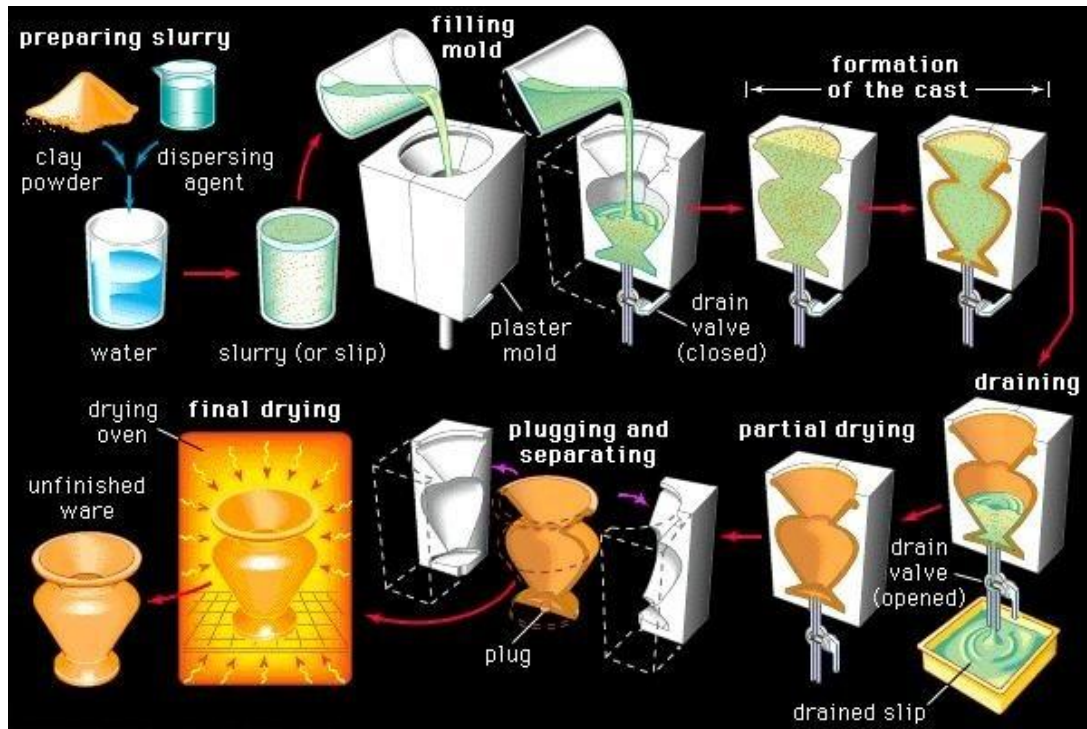

## Tape Casting of Ceramic

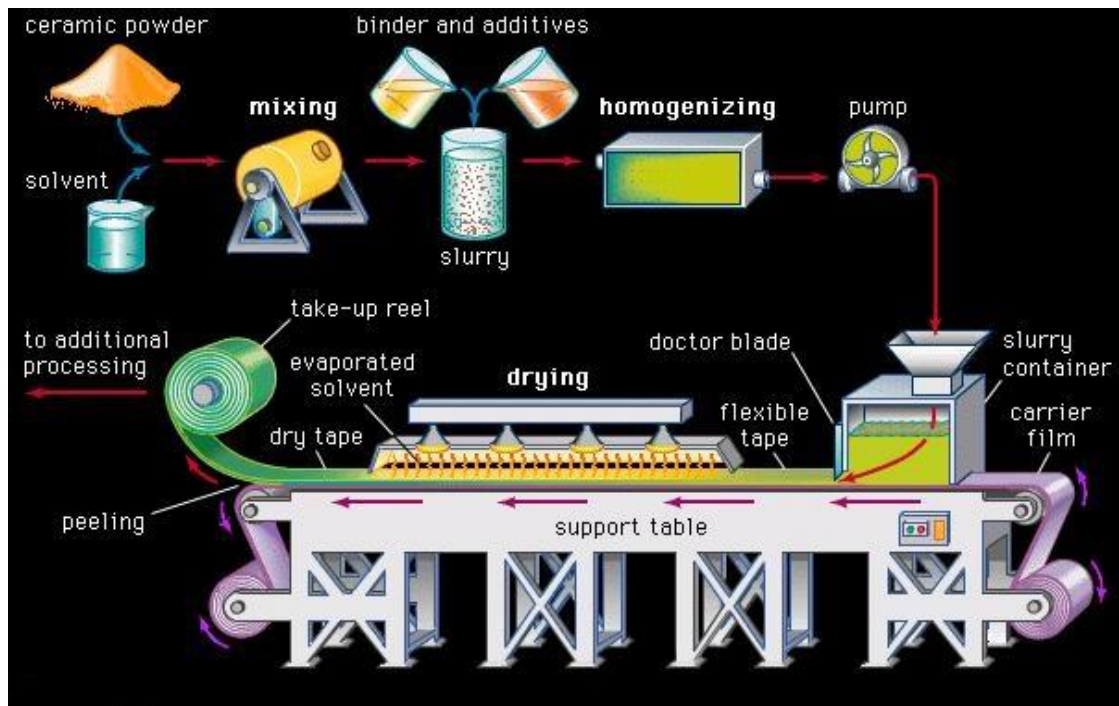

## Hot Powder Extrusion Fabrication

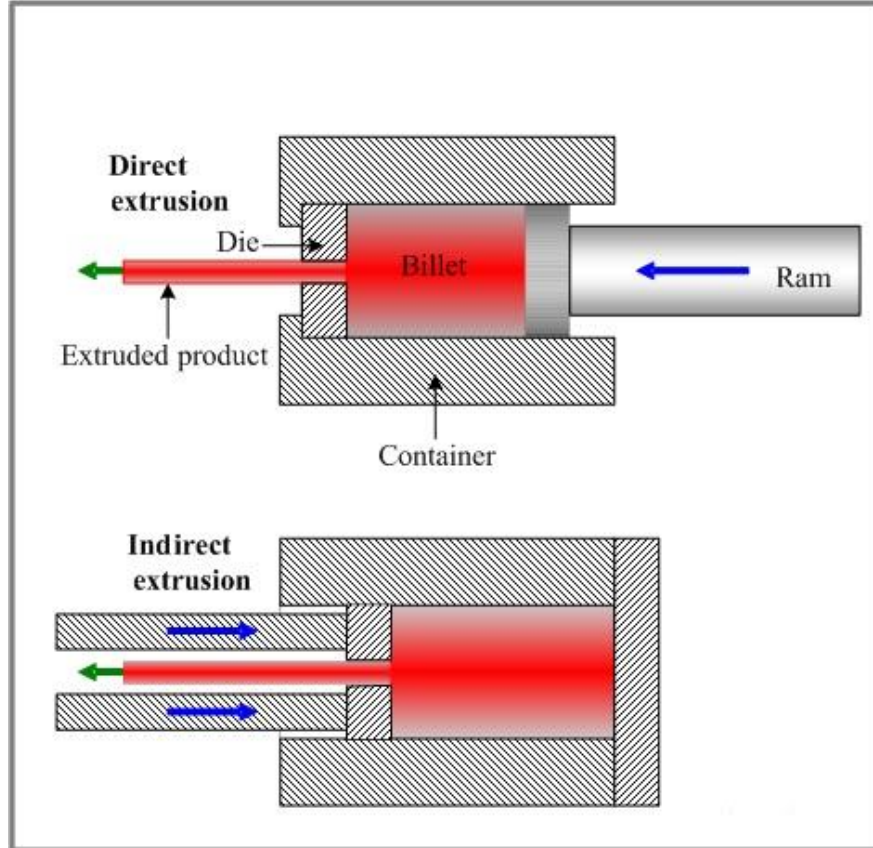





## Low Pressure Injection Molding

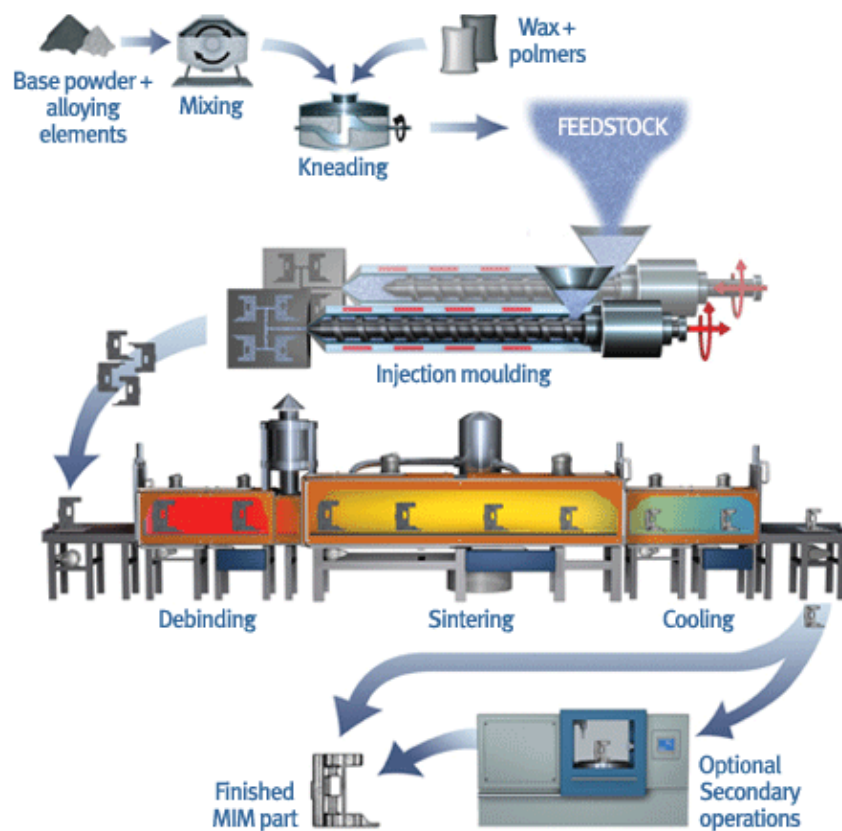

## Green Machining Operations for Ceramic Parts





## Sintering and Firing Process

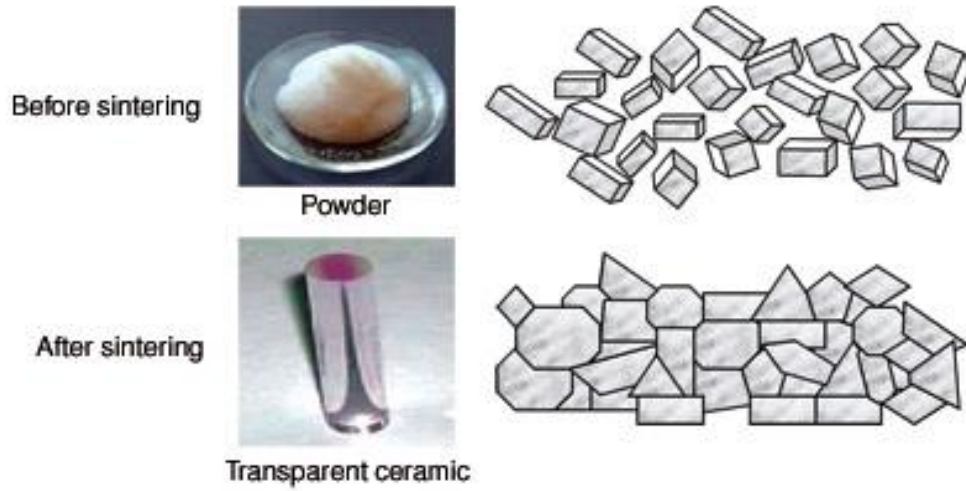

## Bonding Mechanisms in Powder Sintering

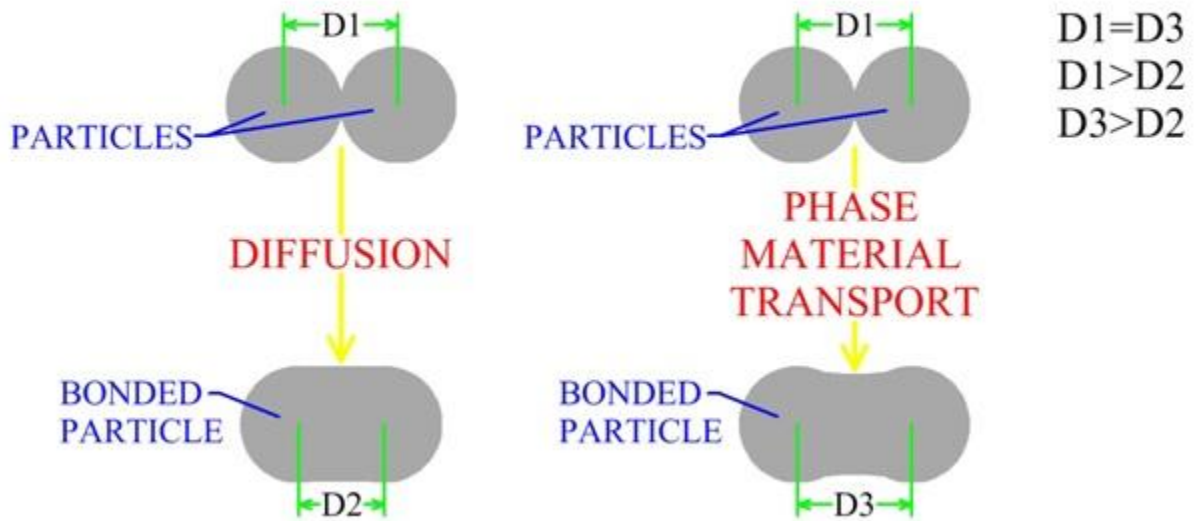

## Continuous Sintering Furnace

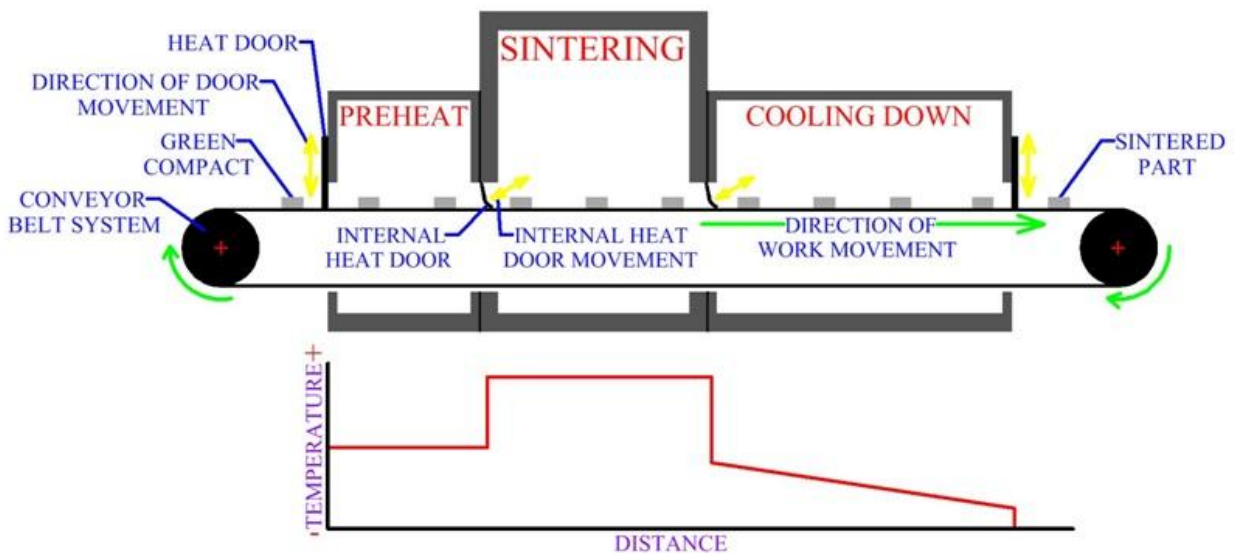

## Firing of Ceramics



## Diamond Grinding of Ceramic

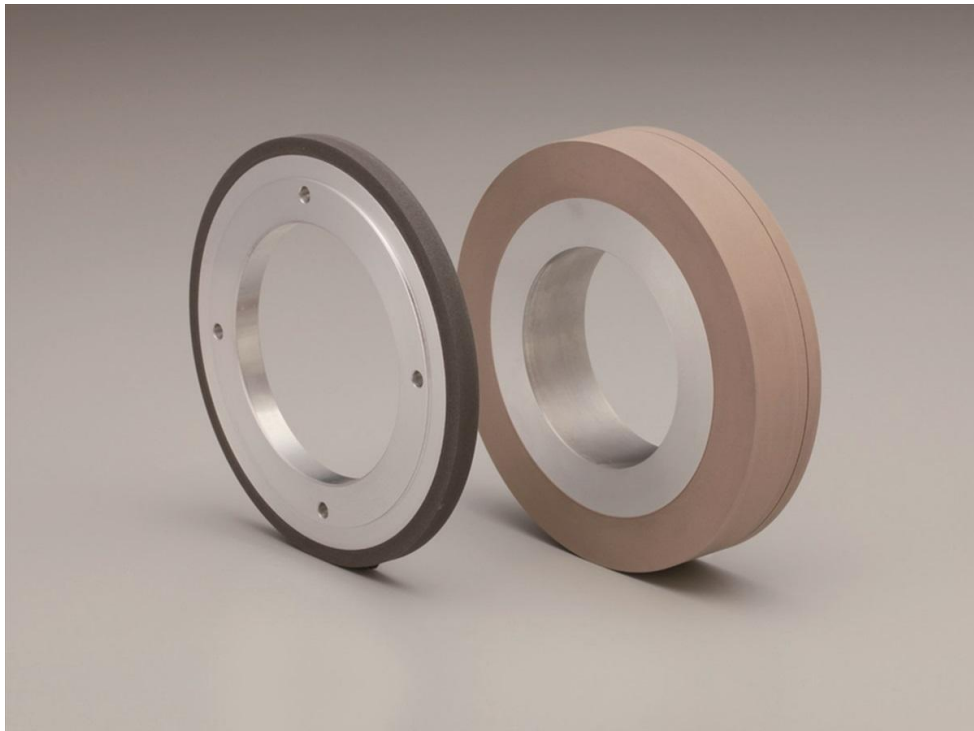

Above are examples of diamond grinding tools

AGS-TECH Inc., Tel: 505-550-6501 and 505-565-5102, Fax: 505-814-5778, Email: [sales@agstech.net](mailto:sales@agstech.net), Web: <http://www.agstech.net>





### **Ceramic Components Used in Hermetic Assemblies**



Light bulbs are probably one of the first and earliest hermetically sealed products that incorporate glass, ceramic and metal in their manufacture

AGS-TECH Inc., Tel: 505-550-6501 and 505-565-5102, Fax: 505-814-5778, Email: [sales@agstech.net](mailto:sales@agstech.net), Web: <http://www.agstech.net>



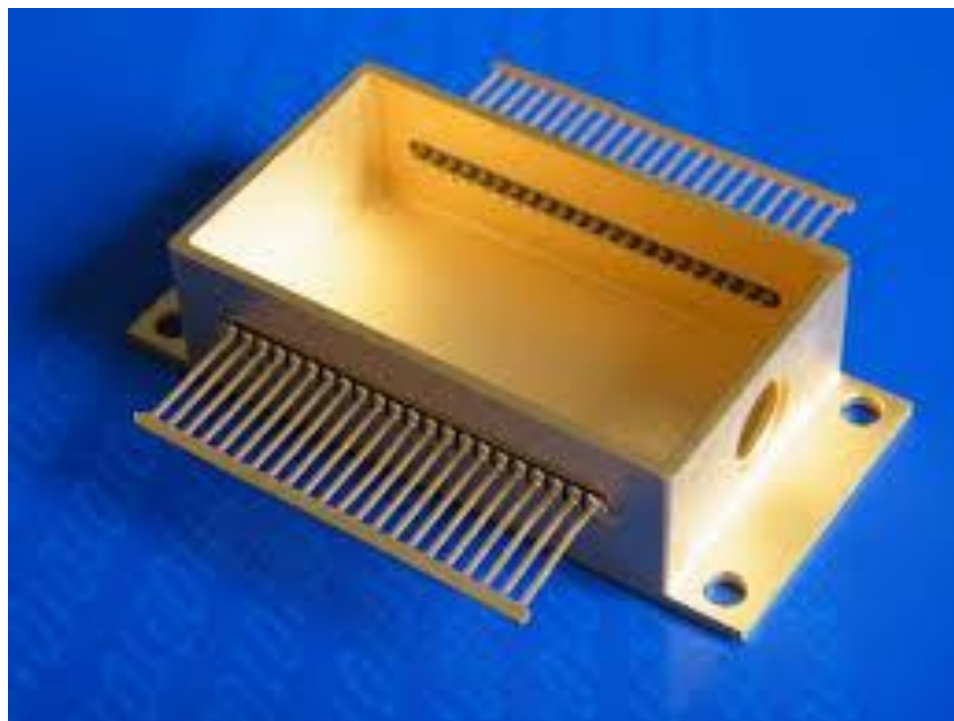
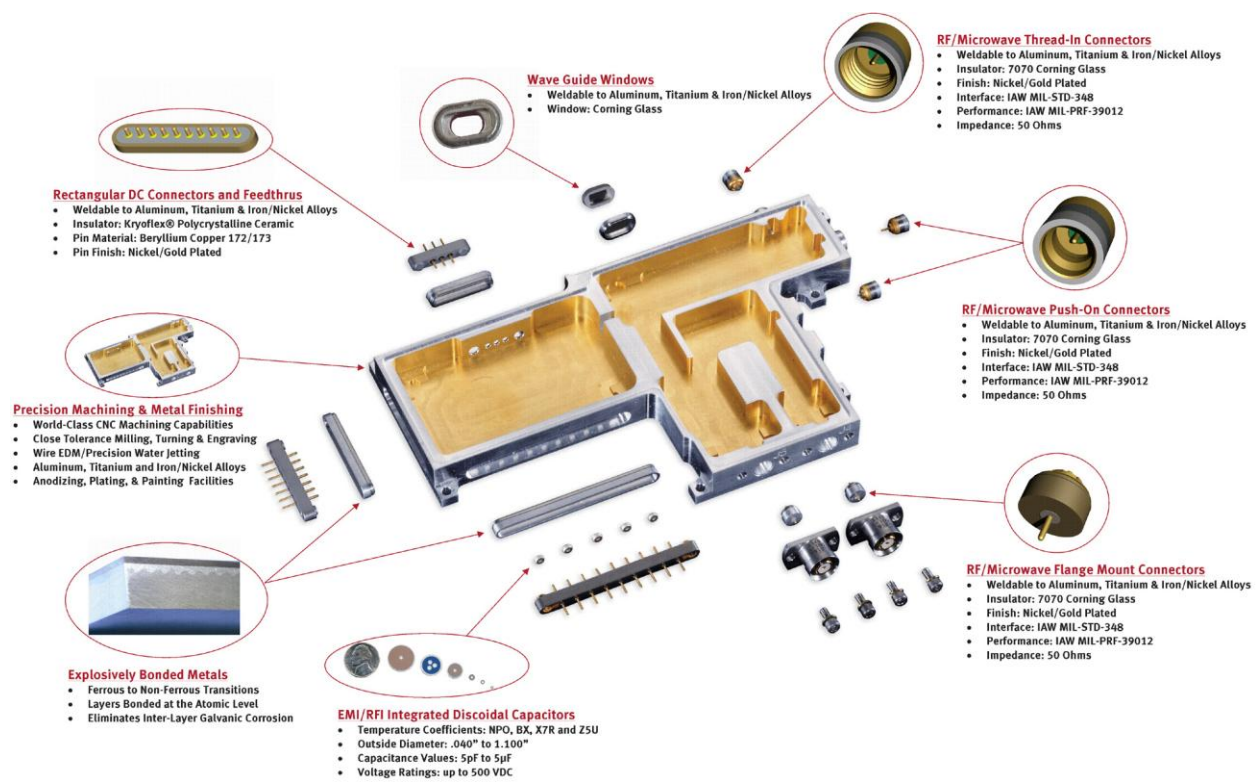

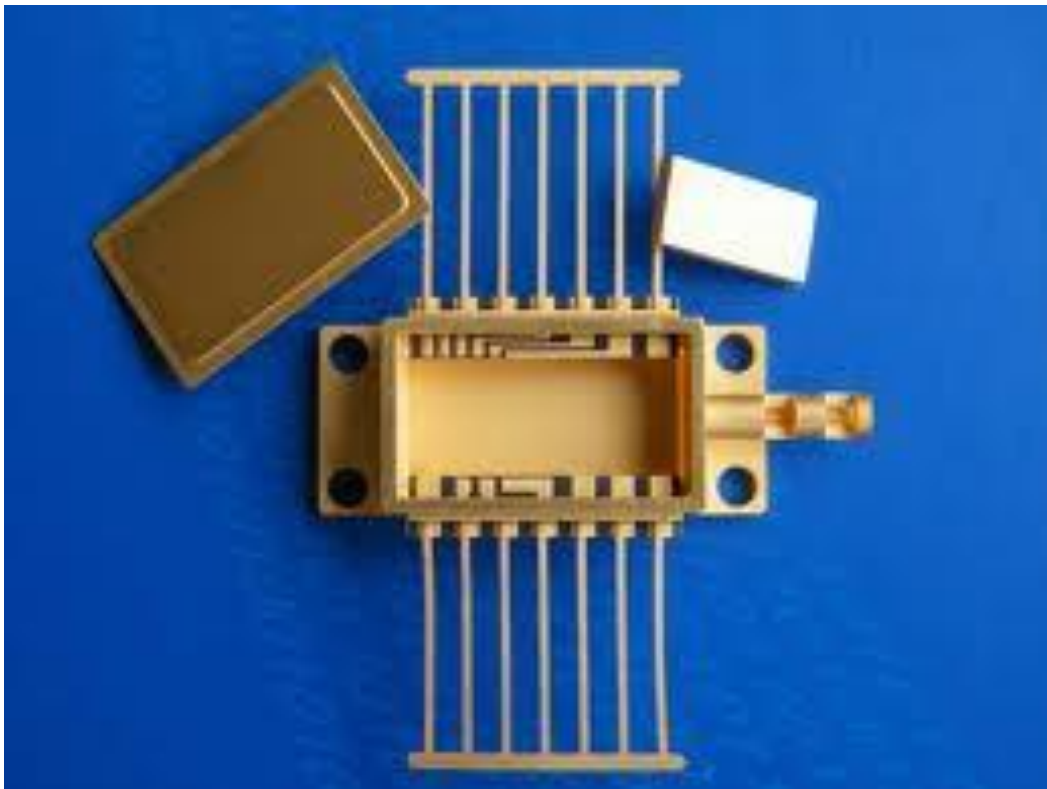



Notice the white ceramic material at the interface between the electrical feedthroughs and the package