

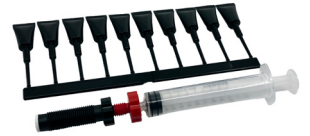

Tel: 505-550-6501  
Fax: 505-814-5778  
Email: sales@agstech.net  
Web: www.agstech.net

# AUTO GLASS REPAIR and REPLACEMENT SYSTEMS

## Private Label Catalog



Registered design



Registered design



The market's fastest, best and most user-friendly solutions

We can put your company name, brand... on these.

PRIVATE LABEL OPTION  
OEM OPTION

Danish design  
Made in Denmark



## Unique technology, tools in registered design, accessories and consumables

Our programme of tools, accessories and consumables for professional auto glass repair has been developed and tested in collaboration with leading specialists in the automotive glass industry.

The programme includes technology and tools in registered design that position us as a leading supplier of solutions within repair and replacement of auto glass.

The product range is also offered in private label brand to wholesalers in the automotive industry, which in addition to thorough training (training academy) also receives marketing material - including videos made available.

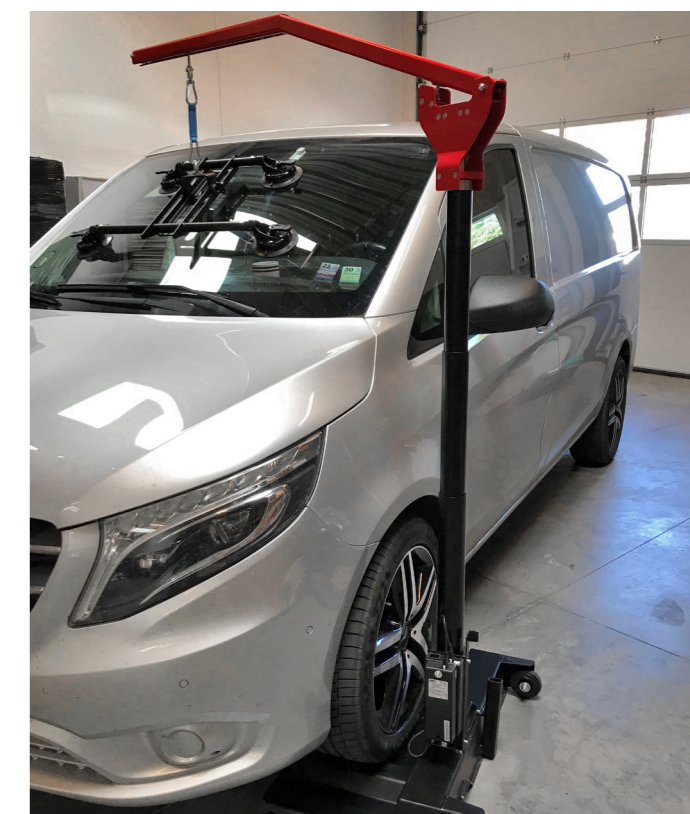

### Auto glass chip repair

In windscreen chip repair, we set completely new standards for speed, simplicity and repair quality. Compared to other repair systems - with a minimum of training - stone chip repairs can be carried out in just 5 minutes and with a success rate of 95-98%.

The repair process requires neither access to power nor vacuum equipment, is mobile and can therefore also be performed at the customer.

Depending on the need, the repair kits are available in four different versions. The contents and the necessary consumables can be ordered separately.

Get detailed information on the following pages ...

### Auto glass replacement

With in-house developed tools, we also set new standards for speed, simplicity and repair quality within autoglass removal.

By using our cutting set, the cutting work - with a minimum of training - can not only be performed much faster, but also by just one person and with all types of cutting wire/thread.

Depending on the need, the cut-out kits are available in two different versions. The contents and the necessary consumables can be ordered separately.

Get detailed information on the following pages ...



## New standard for both speed, simplicity, repair quality and mobility

There are several chip repair systems on the market, but no other performs as well on the four most important parameters:

- Speed
- Simplicity
- Repair quality
- Mobility

## Nice and long lasting repairs

Our specially developed resin differs in several ways. The special viscosity of the resin ensures that it flows out into even the smallest cracks, which has an impact on how efficiently the cracks in the damaged area are joined together and thereby the quality and service life of the repair. The resin also differs by not yellowing over time. This results in a nicer repair.

But also our pit filler differs in several areas. Like the resin, it does not yellow over time and in addition it is characterized by a very high wear resistance. This ensures both a long service life and a nicer repair.

### Chip repair in just 5 minutes

With our 3-in-1 process, a chip repair can be performed in just 5 minutes. After ordinary preparation and cleaning of the chip, the following process steps are performed with our in-house developed repair bridge in registered design:

1. Heating to 60°C and cooling to 20°C in 3 min.
2. Filling and pressure/vacuum process of 60 sec.
3. Curing (LED UV curing 30 sec. and with 95-98% invisibility after curing)

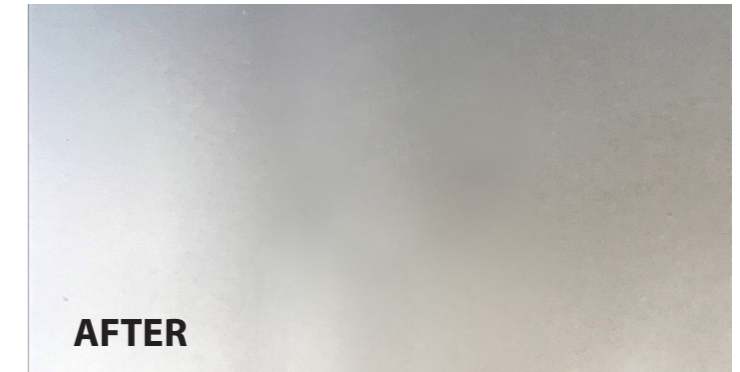
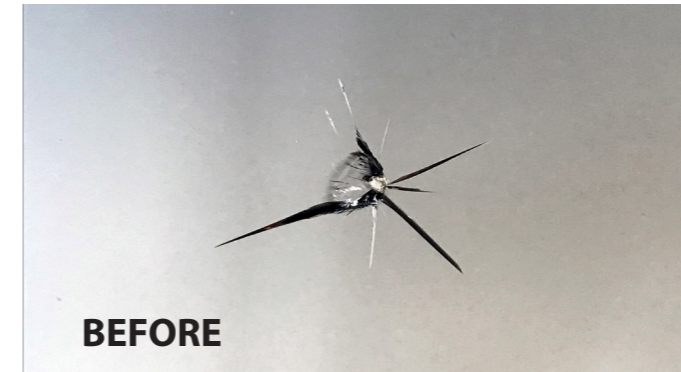

### In the workshop or on the road

Most stone chip repair processes include the use of vacuum technology, which often makes mobile use a challenge. With our in-house developed pressure/vacuum tool in registered design, repairs can be carried out at the customer's as well as in the workshop. A stone chip repair requires NO access to electricity.

### In private label and with everything you need to get off to a good start

The product range is also offered in private label to wholesalers in the automotive aftermarket. In addition to the mandatory training and coaching of the wholesaler's staff, we also offer marketing material so that you as a wholesaler get off to a good and quick start, for example:

- Brochures
- Demonstration video with own employees
- Website setup with customer support function
- Sticker for covering chip with contact details

### Everyone can do chip repairs after a brief introduction

Our system is so simple to work with that EVERYONE - after a short introduction - can do the work. So no special prerequisites are needed. It is therefore obvious for car repair shops to offer their customers this service.







K4200i	
Article #	Description
K4200i-3	Automatic vacuum system
K4200i-2	Blue tube with quick connections, for K4200i-3
K4213-2	Repair bridge 3-in-1
3027	Charging cable
K4221-1	Glass drill machine 3,6 V incl. charging cable
K4212-5	Glass drills ball ended x 5
K4208-1	Pressure/vacuum piston and syringe
K4220	Slide hammer
K4230	Curing film square x 5
K4211	Razor blades x 5
K4205	Pit filler 5 ml
K4214-1	Mirror with suction cup adjustable
910008	Syringe and needle
K4207-1	Gel 10 ml
K4202	Crack resin 5 ml
K4206-1	Polish 10 ml
3012	Box for K4200C and K4200H
2060	Lighter
4008	Adapter 220 V
K4202-2	Resin set ( 10 x pipette )
4008-i	Adapter 12,6V
K4208-i	Air injector



K4200i-1	
Article #	Description
K4200i-3	Automatic vacuum system
K4200i-2	Blue tube with quick connections, for K4200i-3
K4213-3	Repair bridge 2-in-1 unit
3027	Charging cable
K4221-1	Glass drill machine 3,6 V incl. charging cable
K4212-5	Glass drills ball ended x 5
K4208-1	Pressure/vacuum piston and syringe
K4220	Slide hammer
K4230	Curing film square x 5
910008	Syringe and needle
K4211	Razor blades x 5
K4205	Pit filler 5 ml
K4214-1	Mirror with suction cup adjustable
K4207-1	Gel 10 ml
K4202	Crack resin 5 ml
K4206-1	Polish 10 ml
3012	Box for K4200C and K4200H
2060	Lighter
4008	Adapter 220 V
K4202-2	Resin set ( 10 x pipette )
4008-i	Adapter 12,6V
K4208-i	Injector with quickconnection

Complete system for repairing stone chips and cracks, with fully automatic pressure & vacuum.  
 You get 2 systems in 1, as it is possible to use both fully automatic as well as manual pressure and vacuum.  
 With 95-98% invisibility after curing.

Our patented 3-in-1 system with three positions, each having its own process.  
 - Heat approximately 60 degrees to draw out moisture & water, and cooling to about 25 degrees.  
 - Fully automatic pressure & vacuum 6 min.  
 - UV light for curing, 30 seconds.

Includes resin for 45 repairs.  
 All devices on power are cable-free and rechargeable.  
 Time required: 8-10 minutes.

Complete system for repairing stone chips and cracks, with fully automatic pressure & vacuum.  
 You get 2 systems in 1, as it is possible to use both fully automatic as well as manual pressure and vacuum.  
 With 95-98% invisibility after curing.

Our 2-in-1 system with three positions, each having its own process.  
 - Fully automatic pressure & vacuum 6 min.  
 - UV light for curing, 60 seconds.  
 Includes resin for 45 repairs.  
 All devices on power are cable-free and rechargeable.  
 Time required: 8-10 minutes.







NEW

K4200i-4	
Article #	Description
K4200i-3	Automatic vacuum system
K4200i-2	Blue tube with quick connections, for K4200i-3
3012	Box for K4200C and K4200H
4008-i	Adapter 12,6V
K4208-i	Air injector



Supplement set with automatic pressure & vacuum 6 min.  
 With this set, you ensure correct pressure and vacuum every time and you are freed up for other work.  
 All devices on power are cable-free and rechargeable.



K4200C	
Article #	Description
K4213-2	Repair bridge 3-in-1
K4213	Repair bridge
K4215A	UV-led lamp 30 sec. curing time
3027	Charging cable
K4221-1	Glass drill machine 3,6 V incl. charging cable
K4212-5	Glass drills ball ended x 5
K4208-1	Pressure/vacuum piston and syringe
K4220	Slide hammer
K4219	Crack expander
K4230	Curing film square x 5
K4210	Curing film roll
K4211	Razor blades x 5
K4205	Pit filler 5 ml
K4214-1	Mirror with suction cup adjustable
910008	Syringe and needle
K4207-1	Gel 10 ml
K4202	Crack resin 5 ml
K4206-1	Polish 10 ml
3012	Box for K4200C and K4200H
2060	Lighter
4008	Adapter 220 V
K4202-2	Resin set ( 10 x pipette )
K4202-3	Crack resin set 1 ( K4208-1, 910008, K4202 )
K4202-4	Pit filler set 2 ( K4211, K4230, K4205 )

Complete system for repairing stone chips and cracks.  
 With 95-98% invisibility after curing.

Our patented 3-in-1 system with 3 positions, each having its own process.  
 - Heat approximately 60 degrees to draw out moisture & water, and cooling to about 25 degrees.  
 - Injector pressure & vacuum.  
 - UV light for curing, 30 seconds.

Includes resin for approximately 75 repairs.  
 The insert is movable and attaches to the windshield, so everything is at hand.  
 All devices on power are cable-free and rechargeable.  
 Time required: 5-7 minutes.





K4200H	
Article #	Description
K4213-2	Repair bridge 3-in-1
K4221-1	Glass drill machine 3,6 V incl. charging cable
K4212-5	Glass drills ball ended x 5
K4208-1	Pressure/vacuum piston and syringe
K4220	Slide hammer
K4230	Curing film square x 5
K4211	Razor blades x 5
K4205	Pit filler 5 ml
K4214-1	Mirror with suction cup adjustable
910008	Syringe and needle
K4207-1	Gel 10 ml
K4202	Crack resin 5 ml
K4206-1	Polish 10 ml
3012	Box for K4200C and K4200H
2060	Lighter
4008	Adapter 220 V
K4202-2	Resin set ( 10 x pipette )
K4202-3	Crack resin set 1 ( K4208-1, 910008, K4202 )
K4202-4	Pit filler set 2 ( K4211, K4230, K4205 )



Complete system for repairing stone chips.  
With 95-98% invisibility after curing.

- Our patented 3-in-1 system with 3 positions, each having its own process.
- Heat approximately 60 degrees to draw out moisture & water, and cooling to about 25 degrees.
  - Injector pressure & vacuum.
  - UV light for curing, 30 seconds.

Includes resin for approximately 75 repairs.  
The insert is removable and attached to the window so that everything is at hand.  
All devices on power are cable-free and rechargeable.  
Time required: 5-7 minutes.



K4200D-1	
Article #	Description
K4213-2	Repair bridge 3in1
3027	Charging cable
K4214-1	Mirror with suction cup adjustable
K4208-1	Pressure/vacuum piston and syringe
K4230	Curing film square x 5
K4211	Razor blades x 5
K4202	Crack resin 5 ml
K4205	Pit filler 5 ml
K4206-1	Polish 10 ml
910008	Syringe and needle
3012	Box for K4200C and K4200H



Repair bridge for repairing stone chips.  
With 95-98% invisibility after curing.

- Our patented 3-in-1 system with 3 positions, each having its own process.
- Heat approximately 60 degrees to draw out moisture & water, and cooling to about 25 degrees.
  - Injector pressure & vacuum.
  - UV light for curing, 30 seconds.

Includes resin for 35 repairs.  
The insert is removable and attached to the window so that everything is at hand.  
All devices on power are cable-free and rechargeable.  
Time required: 5-7 minutes.





K4200D	
Article #	Description
K4213-2	Repair bridge 3in1
3027	Charging cable
K4214	Mirror with suction cup
K4208-1	Pressure/vacuum piston and syringe
K4230	Curing film square x 5
K4211	Razor blades x 5
K4202	Crack resin 5 ml
K4205	Pit filler 5 ml
K4206-1	Polish 10 ml
910008	Syringe and needle
3010	Box for K4200D



Repair bridge for repairing stone chips.  
With 95-98% invisibility after curing.

Our patented 3-in-1 system with 3 positions, each having its own process.

- Heat approximately 60 degrees to draw out moisture & water, and cooling to about 25 degrees.
- Injector pressure & vacuum.
- UV light for curing, 30 seconds.

Includes resin for 35 repairs.  
All devices on power are cable-free and rechargeable.  
Time required: 5-7 minutes.



K4200K	
Article #	Description
K4213-2	Repair bridge 3-in-1
3027	Charging cable
K4208-1	Pressure/vacuum piston and syringe
K4202-2	Resin set ( 10 x pipette )
4008	Adapter 220 V
3012	Box for K4200C and K4200H



Supplement set of 3-in-1.

With this set, you can complement your old set with the unique 3-in-1 and perform the perfect stone chip repair.

Our patented 3-in-1 system with 3 positions, each having its own process.

- Heat approximately 60 degrees to draw out moisture & water, and cooling to about 25 degrees.
- Injector pressure & vacuum.
- UV light for curing, 30 seconds.

All devices on power are cable-free and rechargeable.  
Time required: 5-7 minutes.





**NEW**

K4200L	
Article #	Description
K4213-3	Repair bridge 2-in-1 unit
3027	Charging cable
K4208-1	Pressure/vacuum piston and syringe
3012	Box for K4200C and K4200H
4008	Adapter 220 V
K4202-2	Resin set ( 10 x pipette )



Supplement set of 2-in-1.  
 With this set, you can complement your old set with the unique 2-in-1 and perform the perfect stone chip repair.

Our 2-in-1 system with 2 positions, each having its own process.  
 - Injector pressure & vacuum.  
 - UV light for curing, 60 seconds.

Includes resin for 10 repairs.  
 All devices on power are cable-free and rechargeable.  
 Time required: 2-3 minutes.



K4200G	
Article #	Description
K4213-3	Repair bridge 2-in-1 unit
K4221-1	Glass drill machine 3,6 V rechargeable
K4208-1	Vacumm injector plastic
K4211	Razor blades x 5
K4230	Curing film square x 5
K4205	Pit filler 5 ml
4026	Carbide Probe
k4202-2	Crack resin set ( 10 x pipette/ampoule )
K4212-5	Glass drills ball ended 5 pcs
K4214-1	Mirror w/suctioncup flexible
K4206-1	Polish ( 10 ml )
4029	Cartonbox
4030	Foam 2-in-1 set



System for repairing stone chips.  
 With 95-98% invisibility after curing.

Our 2-in-1 system with 2 positions, each having its own process.  
 - Injector pressure & vacuum.  
 - UV light for curing, 60 seconds.

Includes resin for 10 repairs.  
 All devices on power are cable-free and rechargeable.  
 Time required: 2-3 minutes.





REPAIR SYSTEMS



K4200i      K4200C      K4200H      K4200G

Stone chips	●	●	●	●
Cracks		●		
Automatic pressure/vacuum	●			
3-in-1*	●	●	●	
2-in-1				●
Consumables included	●	●	●	●
Resin for x amount of chips	45	75	75	10

\*Alle systemer kan leveres med vores 2i1, til reduceret pris

SUPPLEMENTARY SYSTEMS



K4200i-4      K4200K      K4200L      K4200D-1

Stone chips	●	●	●	●
Cracks				
Automatic pressure/vacuum	●			
3-in-1		●		●
2-in-1			●	
Consumables included		●	●	●
Resin for x amount of chips	0	10	10	35

OUR REPAIR BRIDGES



**Reparationsbro 3i1**

Our patented 3-in-1 system with 3 positions, each having its own process.

- Heat approximately 60 degrees to draw out moisture & water, and cooling to about 25 degrees.
- Injector pressure & vacuum.
- UV light for curing, 30 seconds.
- Automatically turns off light when flipped over. Protects eyes from UV-light.



**Reparationsbro 2i1**

Our 2-in-1 system with 2 positions, each having its own process.

- Injector pressure & vacuum.
- UV light for curing, 60 seconds.



**Reparationsbro 2i1 med UV hærkning under tryk**

Our 2-in-1 system with 2 positions, each having its own process.

- Injector pressure & vacuum.
- UV light for curing, 60 seconds + ekstra UV light for curing under pressure



**Removable insert in All of our systems (except our K4200i- systems and K4200D).**

Easily removed from the case and placed on the windscreen. This way you have everything at your fingertips regardless of working conditions.



**K4208-1**  
Pressure/vacuum piston and syringe



**K4202-2**  
Resin ( 10 x pipette )



**K4208-3**  
Resin 100 pcs. (10 x 10 pipette)



**K4202-1**  
Resin set 1 ( K4208-1, K4202-2)



**910002B**  
Resin 1,6 10 ml



**910004**  
Resin 2 3 ml



**910004A**  
Resin 2 5 ml



**910004B**  
Resin 2 10 ml



**K4202-3**  
Crack resin set 1 ( K4208-1, 910008, K4202 )



**K4202**  
Crack resin 5 ml



**K4203**  
Crack resin 20 ml



**K4204**  
Crack resin 50 ml



**K4202-4**  
Pit filler set 2 ( K4211, K4230, K4205 )



**K4205**  
Pit filler 5 ml



**910022**  
Pit filler 3 ml



**910022A**  
Pit filler 5 ml



**910028**  
Resin 01 3 ml



**910028A**  
Resin 01 5 ml



**910028B**  
Resin 01 10 ml



**910003**  
Resin 1 3 ml



**910022B**  
Pit filler 10 ml



**K4206-1**  
Polish 10 ml



**K4206**  
Polish 20 ml



**910013**  
Polish 10 ml



**910003A**  
Resin 1 5 ml



**910003B**  
Resin 1 10 ml



**910002**  
Resin 1,6 3 ml



**910002A**  
Resin 1,6 5 ml



**K4207-1**  
Gel 10 ml



**K4207**  
Gel 50 ml



**910023**  
Cup lub 10 ml



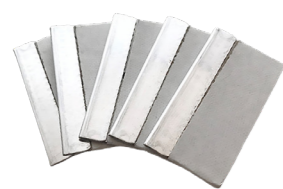

**K4211**  
Razor blades x 5



**910024A**  
Razor blades x 100



**K4230**  
curing film square x 5



**910009**  
Curing film x 5



**K4225**  
Gasket for K4208-1



**910007**  
Gasket for injector 910018



**4008**  
Adapter 220 V



**3027**  
Charging cable



**K4210**  
Curing film roll



**K4209**  
Syringe and needle x 5



**K4212-5**  
Glass drills ball ended x 5



**K4212**  
Glass drills ball ended



**4008-i**  
Adapter 12,6V

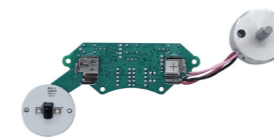

**3018**  
Circuit board for K4213-2



**4030**  
Foam inlay for K4200G



**4004**  
Battery 3,6 V for previous model of drill



**910010C**  
Glass drills cylindrical



**K4223**  
Suction cup set for UV-lamp and crack expander x 4



**4029**  
Cardboard box for K4200G



**3012**  
Box for all systems with removable insert



**3010**  
Box for K4200D



**K4200i-3**  
Automatic vacuum system



**K4213-2**  
Repair bridge 3-in-1  
30 sec. UV



**K4213-4**  
Repair bridge 2-in-1 unit with  
curing under pressure  
60 sec. UV



**K4213-3**  
Repair bridge 2-in-1 unit  
60 sec UV



**K4200i-2**  
Blue tube with quick connec-  
tions, for K4200i-3



**910016**  
Mityvac press/vacuum pump



**K4213-1**  
Repair bridge aluminium with  
suction cup  
For cracks



**K4213**  
Repair bridge  
For cracks



**910019**  
Repair bridge aluminium with  
suction cup



**K4208-i**  
Injector with quickconnection



**K4214-1**  
Mirror with suction cup  
adjustable



**K4214**  
Mirror with suction cup



**K4219**  
Crack expander



**K4221-1**  
Glass drill machine 3,6 V incl.  
charging cable



**K4215A**  
UV-led lamp 30 sec. curing  
time



**K4220**  
Slide hammer



**K4227**  
Tip for slide hammer



**2060**  
Lighter





**Fast auto glass removal performed by just one person**

There are several auto glass removal systems on the market, but ours excels in particular in the following areas.

- Speed
- Up to 65% time saving
- Resource consumption
- Also suitable for difficult autoglass types

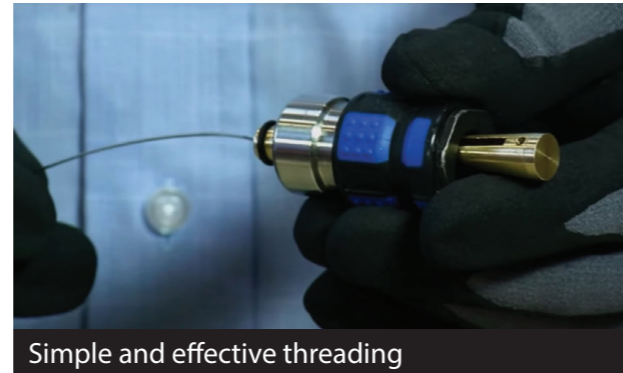

Simple and effective threading

**Interior protection**

When using our two types of protectors

- Dashboard panel with suction cup
- Dashboard panel, straight

it is easy to avoid damaging the interior during the cut-out process.



Dashboard protector with suctions cups

**For all wire/thread types**

We have systems that can be used with all wire types:

- Triangular wire (tensile strenght up to 200kg)
- Square wire (tensile strenght up to 185kg)
- Fiber thread (tensile strenght up to 260 kg)



Thread lead in with thread starter

**Everyone can - after a short introduction - do the work**

Our cut-out system is super easy to use and everyone can do a autoglass removal after a short introduction.



Dashboard protector metal

**Suitable for difficult autoglass types**

On many car and van models, space conditions can be a challenge. In such cases, standard tools can not be used without damaging the vehicle. Our auto glass removal technology, on the other hand, is suitable for all types and in the case of:

- Limited space conditions (dashboard)
- The vehicle is a van



Anchor with suction cup

**In private label and with everything you need to get off to a good start**

The product range is also offered in private label to wholesalers in the automotive aftermarket. In addition to the mandatory training and coaching of the wholesaler's staff, we also offer marketing material so that you as a wholesaler get off to a good and quick start, for example:

- Programme brochure
- Demonstration video with own employees
- Website setup with customer support function
- Own logo on systems and consumables



Plast protector straight with suctions cups

**1-man windscreen cut-out**

In our systems containing the cut-out unit, the unit functions as an extra hand. For this reason, window cutting can be done by just one person. The cut-out unit is easily moved 4-5 times in connection with the cut-out process.



Cut-out - 1-man windscreen cut-out



Protector 60 dgr. bend



K4500C-2	
Article #	Description
K4500C-2B	Cut-out unit
3014	Suction cup for holding the wire Cut-out
K4500K	Direct wire feeder with T-handle with hole
K4500L	Dashboard protector with suction cups
R840049A	Plast protector angle
3022	Bitsholder
3023	Stanley knife
K45HGF-5	Fiberline tensilestrenght 260kg
R930020D	Triangular wire 50 m spec. for Cut-out
3011	Box for K4500C-2

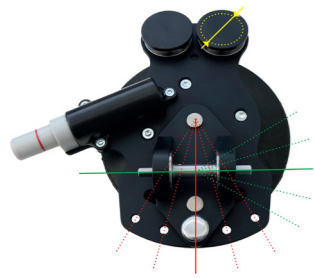

One-man windshield cut-out kit with adjustment.  
 This kit includes an adjustable spool where the angle can be changed, ensuring a stable pull on the wire.

It is used with fiberline or metal wire. The adjustment ensures the wire is always at the correct angle, minimizing the risk of the wire breaking. Additionally, the adjustment ensures there is always space for the screwdriver.  
 A counter hold is mounted externally on the windshield, and the cut-out unit is mounted internally on the windshield.  
 A cordless drill can be used.

Includes 50 m square wire and 100 m fiber line.  
 Time required: 10 minutes.



K4500C-1	
Article #	Description
K4500C-1B	Cut-out unit
3014	Suction cup for holding the wire Cut-out
K4500K	Direct wire feeder with T-handle with hole
K4500L	Dashboard protector with suction cups
R840049A	Plast protector angle
3022	Bitsholder
3023	Stanley knife
K45HGF-5	Fiberline tensilestrenght 260kg
R930020D	Triangular wire 50 m spec. for Cut-out
3011	Box for K4500C-2



One-man windshield cut-out kit.  
 This kit includes a spool and ensures a stable pull on the wire, used with fiberline or metal wire.  
 A counter hold is mounted externally on the windshield, and the cut-out unit is mounted internally on the windshield.  
 A cordless drill can be used.

Includes 50 m square wire and 100 m fiber line.  
 Time required: 10 minutes.





K4500	
Article #	Description
K4513	Self locking wire handle with suction cup
2086-2087	Quick connection
K4500L	Dashboard protector with suction cups
R840049A	Plast protector angle
K4501	Triangular wire 25 m
2090	Box for K4500
K4514	Direct wire feeder with T-handle
2085	Cut-out spring



K4500C-1	
Article #	Description
####	#####

One-man windshield cut-out kit.

This kit uses the well-known spring technique and is used with metal wire. Self-locking wire handles are used externally, and the cut-out spring is mounted internally on the windshield.

Includes 25 m triangular wire.  
Time required: 10 minutes.



**K4500C-2B - our brand new and adjustable cut-out unit with many advantages!**

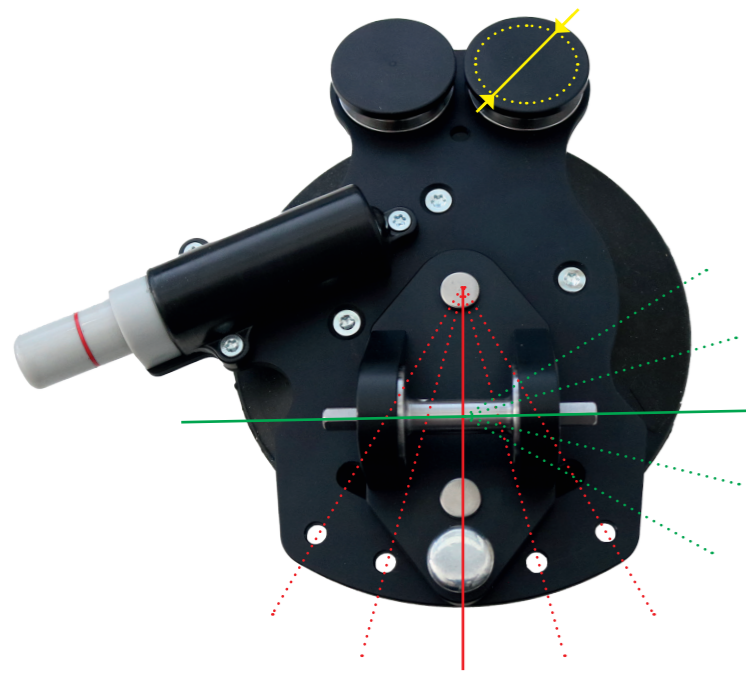

- Adjustability for optimal placement of wheels in proportion to windscreen corners so that the angle of the cutting wire is always optimal.
- Bigger wheels - i.e. larger contact surface as well as detensioning of the cutting wire.
- Adjustability for screwdriver attachment in the case of space constraints.

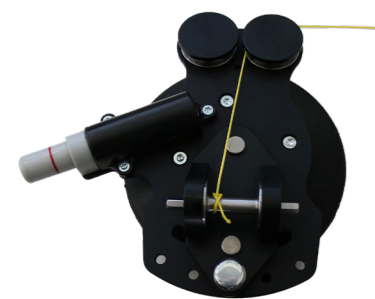

From Ø17 mm (K4500C-1B)  
To Ø30 mm (K4500C-2B)

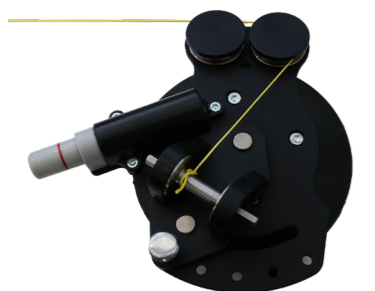
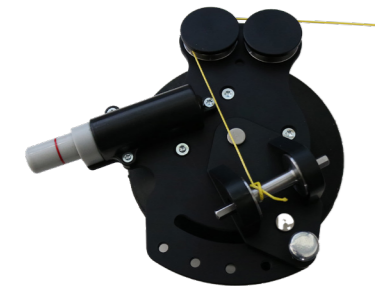

**K4500C-2B**  
Cut-out unit HD



**K4500C-1B**  
Cut-out unit



**3014**  
Suction cup for holding the wire Cut-out



**K45HGF-5**  
Fiber line 100 m tensile strength 260kg



**K4500H**  
Spider fiber line P8 tensile strength 165 kg



**K4503**  
Square wire 25 m 0,6 mm  
Tensile strength 185 kg/1850 N.



**K4503-1**  
Square wire 50 m 0,6 mm  
Tensile strength 185 kg/1850 N.



**R930019C**  
Square wire 50 m 0,6 mm spec. for cut-out systems  
Tensile strength 170 kg/1700 N.



**K4550A**  
Square wire 50 m 0,6 mm spec. for cut-out systems  
Tensile strength 170 kg/1700 N.



**K4501**  
Triangular wire 25 m 0,6 mm  
Tensile strength 200 kg/2000 N.



**K4502**  
Triangular wire 50 m 0,6 mm  
Tensile strength 200 kg/2000 N.



**R930017B**  
Gold wire 3 m



**K4504**  
Gold wire 22,5 m



**R840016**  
Piano wire 10 m



**R930157**  
Feltapplicator 105 mm



**R930157C**  
Feltapplicator 130 mm





**K4902-1**  
MS adhesive  
600ml



**11905**  
Foam Rubber 5x5 mm roll 5 m



**K4500S**  
Sponge for removing silicone  
on glass 10 pcs



**K4500T**  
Sponge for removing silicone  
on glass 100 pcs



**R950072**  
Blade straight/curved 35 mm  
f. aircutter



**R950097**  
Blade straight 57 mm for  
aircutter



**R950081**  
Blade straight 90 mm for  
aircutter



**ESB-1304**  
Blade 100 mm serrated  
Equalizer



**K4903**  
Ceramic cleaner 500 ml spray



**K4510B**  
Pinchweld scraper blade 12  
mm round corners x 10

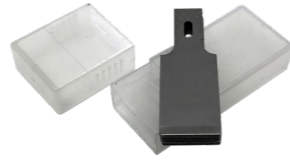

**K4511B**  
Pinchweld scraper blade 16  
mm round corners x 10

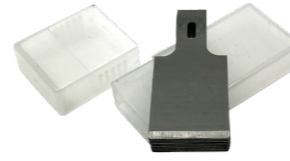

**K4512B**  
Pinchweld scraper blade 20  
mm round corners x 10



**EES-804**  
Holder for 100 mm blade  
Equalizer



**ESB-1308**  
Blade 200 mm serrated  
Equalizer



**EES-808**  
Holder for 200 mm blade  
Equalizer



**ESB-1312**  
Blade 300 mm serrated  
Equalizer



**K4510**  
Pinchweld scraper blade 12  
mm x 10



**K4511**  
Pinchweld scraper blade 16  
mm x 10



**K4512**  
Pinchweld scraper blade 20  
mm x 10



**K4506**  
Blade for cold knife 19 mm  
Ultrawiz



**EES-812**  
Holder for 300 mm blade  
Equalizer



**SHP-150-02**  
Pump for K4500C-1B



**K4517B**  
Suction cup for worktable



**3062**  
Shaft for K4500C-1B



**K4507**  
Blade for cold knife 25 mm  
Ultrawiz



**K4508**  
Blade for cold knife 35 mm  
Ultrawiz



**K4524**  
Blade L-shape 19 mm for  
aircutter



**K4525**  
Blade L-shape 25 mm for  
aircutter



**3034**  
Suction cup for K4500C-1B



**3011**  
Box for K4500 systems



**2090**  
Box for K4500

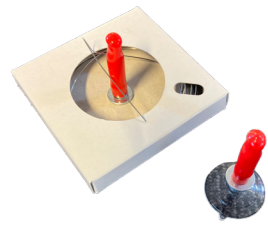

**K4500J**  
Wireholder



**R930116**  
Counter-holder round and wire handle



**K4513**  
Self locking wire handle with suction cup



**R930184**  
Self locking wire handle



**R840051**  
Single suction cup



**K4500L**  
Dashboard protector with suction cups



**R840048B**  
Dashboard protector metal



**R840048C**  
Protector with 60 dgr. bend



**R840015**  
Cut-out kit ( piano wire and wood handles )



**R840017**  
Wire handle wood



**K4500K**  
Direct wire feeder with T-handle with hole



**K4514**  
Direct wire feeder with T-handle



**R840049**  
Plast protector straight with suction cups



**R840049A**  
Plast protector angle



**R930053**  
Glass scraper



**K4509**  
Pinchweld scraper set



**R930129**  
Wirestarter



**K4553**  
Counter-holder round



**K4515B**  
Double suction cup with extra lip adjustable



**K4515**  
Double suction cup with extra lip



**K4509B**  
Pinchweld scraper angled with blades 12, 16 and 20 mm



**R930021**  
Pinchweld scraper with 12 mm blade



**R840084D**  
Cold knife aluminium with Ultrawiz blade



**K4505**  
Cold knife easy change Ultrawiz



**K4515A**  
Double suction cup



**R840054**  
Suction cup vacuum pump Ø 230 mm



**R910056**  
Moulding press



**R840053**  
Large suction cup Pannkoke



**R950001**  
Aircutter



**K4516**  
Long knife heavy duty



**3023**  
Stanley knife



**R861012A**  
Clip remover





**K4554**  
Trim strip remover / Volvo



**R910080**  
Installation stick



**R930016E**  
Wiper arm remover with brass insert



**R930016D**  
Wiper arm remover 2 arms Heavy duty



**R840007**  
Locking strip insert tool 12 mm eye



**R840006**  
Locking strip insert tool 11 mm eye



**R840005**  
Locking strip insert tool 10,5 mm eye



**R840004**  
Locking strip insert tool 9,5 mm eye



**R930016B**  
Wiper arm remover spec.



**R930016A**  
Wiper arm remover



**K4552**  
Wiper arm remover 2 arms



**3022**  
Bitsholder



**R840003**  
Cord insert tool 8 m



**R840002**  
Cord insert tool 7 m



**R840001**  
Cord insert tool 5 m



**2086-2087**  
Quick connection



**R840018**  
General purpose tool short angle



**R840012**  
Ball-pliers long



**R840011**  
Ball-pliers short



**R840010A**  
General purpose tool long



**2085**  
Cut out spring



**WSP-003-S**  
Spider cut-out set



**MS-180-WSP**  
Spider cutting line install tool



**WSP-003K-2**  
Spider shaft



**R840010**  
General purpose tool short



**R840009A**  
Locking strip insert tool with 5 eyes



**R840009**  
Locking strip insert tool with 5 eyes spec. truck



**R840008**  
Locking strip insert tool 15 mm eye



**WSP-003K-BIT-L**  
Spider bit short



**WSP-003K-BIT-K**  
Spider bit short



**WSP-003K-3**  
Spider bearing for shaft





**K45HG-9**  
Milwaukee cordless multi grinder 12 V



**K45HG-10**  
Milwaukee cordless multi grinder 12 V with battery



**K45HG-11**  
Milwaukee cordless multi grinder 12 V with charger and battery



**K45HG-21**  
Milwaukee akku drill machine 12 V with charger and battery



**K45HG-4**  
Milwaukee charger 12 V



**K45HG-3**  
Milwaukee battery 12 V 2,0 AH



**K45HG-22**  
Milwaukee battery 12 V 4,0 AH



**K45HGM**  
Milwaukee cordless caulking gun 12 V 310 ml with charger and battery



**K45HGK-01**  
Milwaukee cordless caulking gun 12 V 420 ml with charger and battery



**K45HG-8**  
Milwaukee barrel clear 420 ml



**K45HG-6A**  
Milwaukee barrel alu 420 ml



**K45HGK**  
Milwaukee cordless caulking gun 12 V 600 ml with charger and battery



**K45HG-7**  
Milwaukee barrel clear 600 ml



**K45HG-5A**  
Milwaukee barrel alu 600 ml



**K45HG-1A**  
Milwaukee sausage adapter red/black



**K45HG-1**  
Milwaukee cartridge adapter black/black



**Don't work harder,  
work smarter...**



Make autoglass replacement:

- A 1-person job
- Efficient
- Economic
- Ergonomic

S10198  
Windshield lift

S10200  
3m wall mounted system

S10300  
3x3m ceiling-mounted rail system

Several mounting options make installation in your system simple

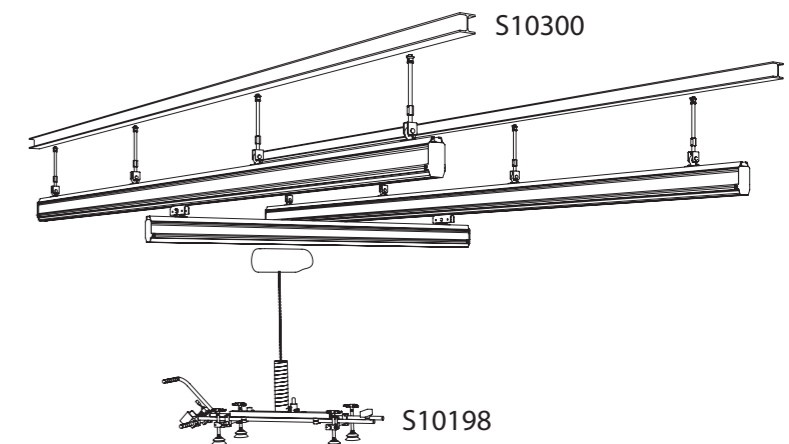
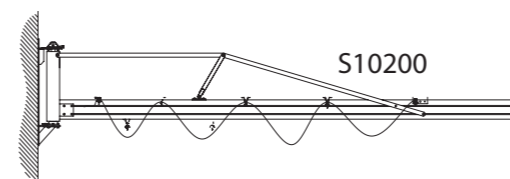





**K4600**  
Windscreen lift for car / van  
max 40 kg



**K4635**  
Extension for windscreen lift  
K4600 + 15cm



**K4603**  
1-man installation tool



**K4650**  
Crane for windows and glass roofs for passenger car / van  
max 80 kg



**41JM30**  
Workstair 30 cm



**41JM52**  
Workstair 52 cm



**R840046A**  
Seatcover double ( available  
with your logo )



**R840045A**  
Hoodcover ( available with  
your logo )



**K4700**  
Windscreen lift for bus / truck  
max 140 kg



**K4600-2-3**  
Glasstable with tilt function  
and vacuum suction cup with  
double lip ( for worktable )

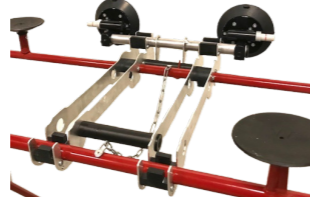

**K4600-2-2**  
Glasstable with tilt function  
and vacuum suction cup ( for  
worktable )



**K4600-2**  
Glasstable with tilt function  
and vacuum suction cup with  
double lip ( for trolley )



**R870040**  
Auto glass shelf van 4 rooms



**R870030**  
Auto glass shelf wall mount-  
ing 3 rooms



**R870045**  
Auto glass shelf van 5 rooms



**R870020**  
Auto glass shelf single 15  
rooms



**K4600-2-1**  
Glasstable with tilt function  
and vacuum suction cup ( for  
trolley )



**R840033**  
Worktable for glass combi  
100 cm



**R840033A**  
Worktable for glass combi  
120 cm



**R840033B**  
Worktable for glass combi  
130 cm

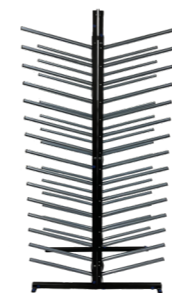

**R870010**  
Auto glass shelf Double 30  
rooms



**K4517**  
Worktable for glass standard



**K4517A**  
Worktable for glass Luxury

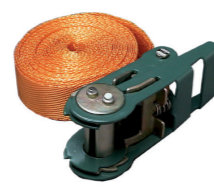

**R840052**  
Tension strap 5 m



**R840047**  
Workstair for tyres



# HEADLIGHT POLISHING/COATING SYSTEM

# HEADLIGHT POLISHING/COATING CONSUMABLES



K4300	
Article #	Description
K4312	Polishing machine SXE400
K4315	Interface pad
K4311	Masking tape
K4302	Sanding disc K400 x 30
K4303	Sanding disc K800 x 30
K4304	Sanding disc K1500 x 30
K4305	Sanding disc K3000 x 10
K4314	Cleaner for headlight x 2
K4317	Polish 50 ml
K4318	Polishing pad orange x 2
K4324	Headlight coating 30 ml



**K4302**  
Sanding disc K400 x 30



**K4303**  
Sanding disc K800 x 30



**K4304**  
Sanding disc K1500 x 30



**K4305**  
Sanding disc K3000 x 10



**K4314**  
Cleaner for headlight x 2



**K4324**  
Headlight coating 30 ml



**K4325**  
Headlight UV-coating spray



**K4317**  
Polish 50 ml



**K4318**  
Polishing pad orange x 2



**K4311**  
Masking tape



**K4329**  
Adapter for interface pad



**K4315**  
Interface pad



# HEADLIGHT POLISHING/COATING TOOLS



**K4312**  
Polishing machine SXE400







Tel: 505-550-6501  
Fax: 505-814-5778  
Email: [sales@agstech.net](mailto:sales@agstech.net)  
Web: [www.agstech.net](http://www.agstech.net)

## **AUTO GLASS REPAIR and REPLACEMENT SYSTEMS**

### **Private Label Catalog**

**We can put your company name, brand....  
on these.**

**PRIVATE LABEL OPTION  
OEM OPTION**