



# OUR COMPANY

## We *Manufacture* Your Tool Brand

### Voted **Best Tool Manufacturer in China!**

Our global network of joint-venture factories have manufactured over 100 million hand & power tools using the latest manufacturing and assembly processes lead by first class chain-supply management.

- 8** Factories
- 22** Years in Business
- 150** Tool Innovations Yearly
- 350** Workers & Staff
- 2000+** Hand & Power Tools Available



Everything you need to **DESIGN, MANUFACTURE & GROW** your private label tool brand in today's ultra-competitive market.



#### Quality Control

For any company to succeed in today's competitive market, they need a strategy that differentiates them from the competition. Quality should not just be an option but rather it's imperative for success. Our practices make sure your standards are met together with international regulatory standards in Quality Assurance and Quality Control.



#### Hand & Power Tool Manufacturing

We understand that not all businesses are the same, so our team of experienced product manufacturers & engineers can tailor tools to match your brand perfectly. Whether you want us to manufacture something new or improve upon an existing tool, we're here for you.



#### Packaging & Merchandising

Retail is competitive. Utilizing eye-catching packaging and a consistent visual brand identity across all packaging is more important than ever. That's why our dedicated designers and packaging team not only develops your Visual Identity (VI), but brings it to life in our dedicated packaging facility.



#### Inventory Management & Distribution

With forecast planning, we hold stock and manage your inventory levels. Our team has the ability to review sales reports for forecasting & adjust stock levels, as well as store and consolidate mixed containers of your private label tool program.



#### Marketing Solutions

Our fully-equipped team of graphic designers, photographers, videographers, on-site studio and strategic marketing experts can provide everything you need to get your product off to the right start.

# CATALOGUE

## HAND TOOLS

<b>P1</b>	<i>PLIERS</i>
<b>P9</b>	<i>PIPE WRENCH</i>
<b>P10</b>	<i>HAND RIVETER</i>
<b>P11</b>	<i>HAND RIVETER/STAPLE GUN</i>
<b>P12</b>	<i>PADLOCK</i>
<b>P13</b>	<i>WRENCH</i>
<b>P18</b>	<i>SOCKET WRENCH</i>
<b>P25</b>	<i>HAMMER</i>
<b>P27</b>	<i>SCREWDRIVER</i>
<b>P30</b>	<i>SCREWDRIVER BITS SET</i>
<b>P32</b>	<i>HEX KEY</i>
<b>P34</b>	<i>PIPE CUTTER</i>
<b>P36</b>	<i>MEASURING TOOLS</i>
<b>P42</b>	<i>VOLTAGE TESTER/CABLE TIE</i>
<b>P43</b>	<i>CLAMP</i>
<b>P44</b>	<i>VICE</i>
<b>P45</b>	<i>KNIFE</i>
<b>P47</b>	<i>SCISSOR</i>
<b>P48</b>	<i>SCISSOR/HACKSAW</i>

<b>P49</b>	<i>HACKSAW</i>
<b>P51</b>	<i>CHISEL</i>
<b>P52</b>	<i>PUNCH</i>
<b>P53</b>	<i>PLANE/WRENCHING BAR/FILES</i>
<b>P54</b>	<i>FILES</i>
<b>P56</b>	<i>WIRE BRUSH/PAINT ROLLER</i>
<b>P57</b>	<i>PAINT ROLLER/GLASS CUTTER</i>
<b>P58</b>	<i>TILE CUTTER</i>
<b>P59</b>	<i>SUCTION LIFT/CAULKING GUN</i>
<b>P60</b>	<i>CAULKING GUN/SCRAPER</i>
<b>P61</b>	<i>SCRAPER &amp; TROWEL</i>
<b>P63</b>	<i>TOOL BOX</i>
<b>P64</b>	<i>TOOL BOX/HAND TRUCK</i>
<b>P65</b>	<i>OUTDOOR TOOLS</i>
<b>P66</b>	<i>HAND TOOL SET</i>
<b>P68</b>	<i>SHEARS</i>
<b>P71</b>	<i>GARDEN TOOLS</i>
<b>P75</b>	<i>SHOVEL</i>



**COMBINATION PLIERS**

- Forged steel, nickel finish
- Bi-color plastic handle
- Packed: PP card hanger

ITEM NO.	SIZE		
HTP1001	160mm,6"	6	60
HTP1002	180mm,7"	6	60
HTP1003	200mm,8"	6	60



**LONG NOSE PLIERS**

- Forged steel, nickel finish
- Bi-color plastic handle
- Packed: PP card hanger

ITEM NO.	SIZE		
HTP1004	160mm,6"	6	60
HTP1005	200mm,8"	6	60



**DIAGONAL CUTTING PLIERS**

- Forged steel, nickel finish
- Bi-color plastic handle
- Packed: PP card hanger

ITEM NO.	SIZE		
HTP1006	160mm,6"	6	60
HTP1007	180mm,7"	6	60



**HEAVY DUTY DIAGONAL CUTTING PLIERS**

- Forged steel, nickel finish
- Bi-color plastic handle
- Packed: PP card hanger

ITEM NO.	SIZE		
HTP1008	180mm,7"	6	60



**BENT NOSE PLIERS**

- Forged steel, nickel finish
- Bi-color plastic handle
- Packed: PP card hanger

ITEM NO.	SIZE		
HTP1009	160mm,6"	6	60
HTP1010	200mm,8"	6	60



**WIRE STRIPPING PLIERS**

- Forged steel, nickel finish
- Bi-color plastic handle
- Packed: PP card hanger

ITEM NO.	SIZE		
HTP1011	160mm,6"	6	60



**3PCS PLIER SET**

- Forged steel, nickel finish
- Bi-color plastic handle
- 6"/160mm Long nose plier 6"/160mm Diagonal plier 7"/180mm Combination plier
- Packed: double blister

ITEM NO.	SIZE		
HTP1012	3pcs	5	20



**4PCS PLIER SET**

- Forged steel, nickel finish
- Bi-color plastic handle
- 6"/160mm Long nose plier 6"/160mm Diagonal plier
- 7"/180mm Combination plier 10"/250mm Water pump plier
- Packed: double blister

ITEM NO.	SIZE		
HTP1014	4pcs	6	60

HAND TOOLS

POWER TOOL ACCESSORIES

CAR TOOLS

POWER TOOLS

AIR TOOLS

GARDEN TOOLS

# Hand Tools - Pliers



Industrial

## LEVERAGE COMBINATION PLIERS

- Forged Chrome Vanadium steel, fine polished
- Power joint saves up to 30% hand load
- Slim shape of waist for better access
- Bi-color plastic handle
- Packed: PP card hanger

ITEM NO.	SIZE		
HTP1015	160mm,6"	6	60
HTP1016	180mm,7"	6	60
HTP1017	200mm,8"	6	60



Industrial

## LEVERAGE LONG NOSE PLIERS

- Forged Chrome Vanadium steel, fine polished
- Power joint saves up to 30% hand load
- Slim shape of waist for better access
- Bi-color plastic handle
- Packed: PP card hanger

ITEM NO.	SIZE		
HTP1018	160mm,6"	6	60
HTP1019	200mm,8"	6	60



Industrial

## LEVERAGE DIAGONAL CUTTING PLIERS

- Forged Chrome Vanadium steel, fine polished
- Power joint saves up to 30% hand load
- Slim shape of waist for better access
- Bi-color plastic handle
- Packed: PP card hanger

ITEM NO.	SIZE		
HTP1020	160mm,6"	6	60
HTP1021	180mm,7"	6	60



## INSULATED COMBINATION PLIERS

- Forged steel, Chrome finish
- Bi-color strong dipped handle
- Packed: PP card hanger

ITEM NO.	SIZE		
HTP1022	160mm,6"	6	60
HTP1023	180mm,7"	6	60
HTP1024	200mm,8"	6	60



## INSULATED LONG NOSE PLIERS

- Forged steel, Chrome finish
- Bi-color strong dipped handle
- Packed: PP card hanger

ITEM NO.	SIZE		
HTP1025	160mm,6"	6	60
HTP1026	200mm,8"	6	60



## INSULATED DIAGONAL CUTTING PLIERS

- Forged steel, Chrome finish
- Bi-color strong dipped handle
- Packed: PP card hanger

ITEM NO.	SIZE		
HTP1027	160mm,6"	6	60
HTP1028	180mm,7"	6	60



Industrial

## VDE COMBINATION PLIERS

- Forged Chrome Vanadium steel, nickel finish
- 1000V insulated, certified to EN 60900
- Non-slip comfort-grip handle
- Packed: PP card hanger

ITEM NO.	SIZE		
HTP1029	160mm,6"	6	60
HTP1030	180mm,7"	6	60
HTP1031	200mm,8"	6	60



Industrial

## VDE LONG NOSE PLIERS

- Forged Chrome Vanadium steel, nickel finish
- 1000V insulated, certified to EN 60900
- Non-slip comfort-grip handle
- Packed: PP card hanger

ITEM NO.	SIZE		
HTP1032	160mm,6"	6	60
HTP1033	200mm,8"	6	60



Industrial

## VDE DIAGONAL CUTTING PLIERS

- Forged Chrome Vanadium steel, nickel finish
- 1000V insulated, certified to EN 60900
- Non-slip comfort-grip handle
- Packed: PP card hanger

ITEM NO.	SIZE		
HTP1034	160mm,6"	6	60
HTP1035	180mm,7"	6	60



Industrial

## VDE WIRE STRIPPING PLIERS

- Forged Chrome Vanadium steel, nickel finish
- 1000V insulated, certified to EN 60900
- Non-slip comfort-grip handle
- Packed: PP card hanger

ITEM NO.	SIZE		
HTP1036	160mm,6"	6	60

HAND TOOLS

POWER TOOL ACCESSORIES

CAR TOOLS

POWER TOOLS

AIR TOOLS

GARDEN TOOLS



Industrial

**PLASTIC CUTTER PLIER**

- Drop forged steel
- Bi-color dipped handle
- Packed: sliding card

ITEM NO.	SIZE		
HTP1037	125mm,5"	12	72
HTP1038	160mm,6"	12	72
HTP1039	180mm,7"	12	72



**FENCING PLIERS**

- Forged steel, fine polished
- Bi-color dipped handle
- Packed: sliding card

ITEM NO.	SIZE		
HTP1040	260mm,10.5"	5	30



Industrial

**SLIP JOINT PLIERS**

- Forged steel
- Surface machine grinding
- Bi-color plastic handle
- Packed: PP card hanger

ITEM NO.	SIZE		
HTP1041	160mm,6"	6	120
HTP1042	200mm,8"	6	60



Industrial

**WATER PUMP PLIERS**

- Forged steel, black finish
- Multi-speed adjustable
- Bi-color dipped handle
- Packed: PP card hanger

ITEM NO.	SIZE		
HTP1043	250mm,10"	6	60
HTP1044	300mm,12"	6	60



Industrial

**WATER PUMP PLIERS**

- Forged steel, black finish
- Multi-speed adjustable
- Bi-color plastic handle
- Packed: PP card hanger

ITEM NO.	SIZE		
HTP1045	250mm,10"		60



Industrial

**GROOVE JOINT PLIERS TYPE A6**

- Forged steel, Chrome finish
- Multi-speed adjustable
- Bi-color dipped handle
- Packed: PP card hanger

ITEM NO.	SIZE		
HTP1046	200mm,8"	6	60
HTP1047	250mm,10"	6	60
HTP1048	300mm,12"	5	40
HTP1049	350mm,14"	5	20
HTP1050	400mm,16"	6	12
HTP1051	500mm,20"	5	10



Industrial

**TOWER PINCER**

- Forged steel, black finish
- Bi-color dipped handle
- Packed: PP card hanger

ITEM NO.	SIZE		
HTP1052	200mm,8"	6	60
HTP1053	225mm,9"	6	60
HTP1054	250mm,10"	6	48



Industrial

**END CUTTING PINCER**

- Forged steel, black finish
- Bi-color dipped handle
- Packed: sliding card

ITEM NO.	SIZE		
HTP1055	160mm,6"	6	60
HTP1056	200mm,8"	6	60

HAND TOOLS

POWER TOOL ACCESSORIES

CAR TOOLS

POWER TOOLS

AIR TOOLS

GARDEN TOOLS

# Hand Tools - Pliers



**Industrial**

## CARPENTER'S PINCER

- Forged steel, black finish
- Bi-color dipped handle
- Packed: PP card hanger

ITEM NO.	SIZE	📦	👤
HTP1057	180mm, 7"	6	60
HTP1058	200mm, 8"	6	60
HTP1059	230mm, 9"	6	60



**Industrial**

## CARPENTER'S PINCER

- Forged steel, black finish
- Handle with pull out pin function
- Packed: PP card hanger

ITEM NO.	SIZE	📦	👤
HTP1060	160mm, 6"	6	60
HTP1061	180mm, 7"	6	60
HTP1062	200mm, 8"	6	60
HTP1063	250mm, 10"	6	60



## CIRCLIP PLIERS (INTERNAL STRAIGHT)

- Forged steel
- Bi-color dipped handle
- Packed: PP card hanger

ITEM NO.	SIZE	📦	👤
HTP1064	180mm, 7"	15	120
HTP1065	230mm, 9"	15	120



## CIRCLIP PLIERS (EXTERNAL STRAIGHT)

- Forged steel
- Bi-color dipped handle
- Packed: PP card hanger

ITEM NO.	SIZE	📦	👤
HTP1066	180mm, 7"	15	120
HTP1067	230mm, 9"	15	120



## CIRCLIP PLIERS (INTERNAL STRAIGHT)

- Forged steel
- Bi-color dipped handle
- Packed: PP card hanger

ITEM NO.	SIZE	📦	👤
HTP1068	180mm, 7"	15	120
HTP1069	230mm, 9"	15	120



## CIRCLIP PLIERS (EXTERNAL STRAIGHT)

- Forged steel
- Bi-color dipped handle
- Packed: PP card hanger

ITEM NO.	SIZE	📦	👤
HTP1070	180mm, 7"	15	120
HTP1071	230mm, 9"	15	120

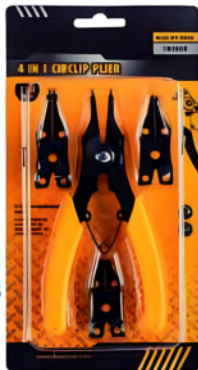

## 4 IN 1 CIRCLIP PLIERS

- Carbon steel plate hardened
- Electrophoresis surface
- PVC soft handle
- Packed: sliding card

ITEM NO.	SIZE	📦	👤
HTP1072	160mm, 6" 4 in 1	6	48



## 4 PCS CIRCLIP PLIERS SET

- Forged steel
- Bi-color dipped handle
- Packed: sliding card

ITEM NO.	SIZE	📦	👤
HTP1073	4pcs 180mm, 7"	5	30

HAND TOOLS

POWER TOOL ACCESSORIES

CAR TOOLS

POWER TOOLS

AIR TOOLS

GARDEN TOOLS



**MINI COMBINATION PLIER**

- Forged steel, nickel finish
- Bi-color dipped handle
- Packed: PP card hanger

ITEM NO.	SIZE		
HTP1074	115mm,4.5"	12	120



**MINI DIAGONAL CUTTING PLIER**

- Forged steel, nickel finish
- Bi-color dipped handle
- Packed: PP card hanger

ITEM NO.	SIZE		
HTP1075	115mm,4.5"	12	120



**MINI LONG NOSE PLIER**

- Forged steel, nickel finish
- Bi-color dipped handle
- Packed: PP card hanger

ITEM NO.	SIZE		
HTP1076	115mm,4.5"	12	120



**MINI NEEDLE NOSE PLIER**

- Forged steel, nickel finish
- Bi-color dipped handle
- Packed: PP card hanger

ITEM NO.	SIZE		
HTP1077	140mm,5.5"	12	120



**MINI END CUTTING PLIER**

- Forged steel, nickel finish
- Bi-color dipped handle
- Packed: PP card hanger

ITEM NO.	SIZE		
HTP1078	115mm,4.5"	12	120



**4PCS MINI PLIERS SET**

- Forged steel
- Bi-color dipped handle
- Packed: sliding card

ITEM NO.	SIZE		
HTP1079	4pcs	6	36



**CURVED JAW LOCKING PLIER**

- Drop forged steel
- Nickle plated
- Packed: slide card

ITEM NO.	SIZE		
HTP1100	125mm,5"	12	120
HTP1101	180mm,7"	6	36
HTP1102	250mm,10"	6	36



**CURVED JAW LOCKING PLIER**

- Drop forged CrV
- Nickle plated
- Packed: half double blister

ITEM NO.	SIZE		
HTP1103	180mm,7"	6	36
HTP1104	250mm,10"	6	36



HAND TOOLS

POWER TOOL ACCESSORIES

CAR TOOLS

POWER TOOLS

AIR TOOLS

GARDEN TOOLS



# Hand Tools - Pliers

Industrial



**STRAIGHT JAW LOCKING PLIER**

- Drop forged Cr-V
- Nickel plated
- Packed: half double blister

ITEM NO.	SIZE		
HTP1105	180mm, 7"	6	36
HTP1106	250mm, 10"	6	36

**LONG NOSE LOCKING PLIER**

- Drop forged steel
- Nickel plated
- Packed: slide card

ITEM NO.	SIZE		
HTP1107	115mm, 4.5"	6	120
HTP1108	165mm, 6.5"	6	36
HTP1109	220mm, 9"	6	36

Industrial



**LONG NOSE LOCKING PLIER**

- Drop forged Cr-V
- Nickel plated
- Packed: half double blister packaging

ITEM NO.	SIZE		
HTP1111	165mm, 6.5"	6	60
HTP1112	220mm, 9"	6	36

Industrial



**FRENCH TYPE LOCKING PLIER**

- Drop forged steel
- Nickel plated
- Packed: slide card

ITEM NO.	SIZE		
HTP1114	250mm, 10"	6	36

**SHEET METAL LOCKING PLIER**

- Drop forged Cr-V
- Nickel plated
- Packed: plastic hanger

ITEM NO.	SIZE		
HTP1115	250mm, 10"	4	20



**WELDING CLAMP LOCKING PLIER**

- Drop forged Cr-V
- Nickel plated
- Packed: plastic hanger

ITEM NO.	SIZE		
HTP1116	220mm, 9"	4	20

Industrial



**C CLAMP LOCKING PLIER**

- Drop forged Cr-V
- Nickel plated
- Packed: plastic hanger

ITEM NO.	SIZE		
HTP1117	275mm, 11"	4	20

Industrial



**C CLAMP LOCKING PLIER WITH ANVIL**

- Drop forged Cr-V
- Nickel plated
- Packed: plastic hanger

ITEM NO.	SIZE		
HTP1118	275mm, 11"	4	20

Industrial



**CHAIN TYPE LOCKING PLIERS**

- Drop forged Cr-V
- Nickel plated
- Carbon steel stamping of pliers body
- Packed: double blister

ITEM NO.	SIZE		
HTP1119	250mm, 10"	6	36

**REVOLVING PUNCH PLIER**

- Punch hole sizes: 2, 2.5, 3, 3.5, 4, 4.5mm
- Cr-V, hardened chrome plated
- Packed: tie on card

ITEM NO.	SIZE		
HTP1120	225mm, 9"	10	50

**REVOLVING PUNCH PLIER**

- Punch hole sizes: 2, 2.5, 3, 3.5, 4, 4.5mm
- Cr-V, hardened black finish
- Packed: tie on card

ITEM NO.	SIZE		
HTP1121	225mm, 9"	10	50

Industrial



HAND TOOLS

POWER TOOL ACCESSORIES

CAR TOOLS

POWER TOOLS

AIR TOOLS

GARDEN TOOLS

Industrial



**LABOR SAVING REVOLVING PUNCH PLIER**

- Punch hole sizes: 2, 2.5, 3, 3.5, 4, 4.5mm
- Cr-V, hardened black finish
- Packed: tie on card

ITEM NO.	SIZE		
HTP1122	225mm,9"	10	50

Industrial



**BOLT CUTTER**

- Cr-V blade, Satin finish
- Packing: tie on card

ITEM NO.	SIZE		
HTP1123	350mm,14"	1	20
HTP1124	450mm,18"	1	10
HTP1125	600mm,24"	1	8
HTP1126	750mm,30"	1	10
HTP1127	900mm,36"	1	8

HAND TOOLS

POWER TOOL ACCESSORIES

CAR TOOLS

POWER TOOLS

AIR TOOLS

GARDEN TOOLS



**BOLT CUTTER**

- Cr-V industrial steel fine polished
- Packing: tie on card

ITEM NO.	SIZE		
HTP1128	300mm,12"	1	30
HTP1129	350mm,14"	1	30
HTP1130	450mm,18"	1	20
HTP1131	600mm,24"	1	10
HTP1132	750mm,30"	1	5
HTP1133	900mm,36"	1	5

**MINI BOLT CUTTER**

- Cr-V blade
- Cutting edges induction quenched
- With comfortable pvc grips
- A lock in the end of handle
- Packing: slide card



ITEM NO.	SIZE		
HTP1134	200mm,8"	6	60

Industrial



**AUTOMATIC WIRE STRIPPER**

- Punch hole sizes: 0.5-2mm
- Nylon body high strength
- Packing: slide card

ITEM NO.	SIZE		
HTP1135	180mm,7"	6	60

**WIRE STRIPPER**

- Black finish
- Cr-V
- Grounded teeth
- Packing: slide card



ITEM NO.	SIZE		
HTP1136	170mm,6.5" 0.8-2.6mm	12	120



**CRIMPING PLIER**

- Black finish
- Cr-V
- Grounded teeth
- Packing: slide card

ITEM NO.	SIZE		
HTP1137	230mm,9" 0.8-2.6mm	12	72

**AUTOMATIC WIRE STRIPPER**

- Zinc alloy body
- 65Mn blade
- Knife shape: 1.0-1.6-2.0-2.6-3.2mm
- PVC handle
- Packing: slide card



ITEM NO.	SIZE		
HTP1138	170mm,6.5" 1-3.2mm	6	48

# Hand Tools - Pliers



Industrial

## ELECTRONICAL PLIERS

- 65Mn body
- PVC handle
- Packing: slide card

ITEM NO.	SIZE		
HTP1139	115mm,4.5"	12	144



## 9" RATCHET CRIMPING PLIER

- Professional quality crimping tool for non-insulated terminals
- PVC handle
- Crimping Capacity: 0.5-6mm<sup>2</sup>
- Packing: slide card

ITEM NO.	SIZE		
HTP1140	230mm,9"	6	48



Industrial

## NETWORK CLAMPING PLIER

- Dual modular plug crimp strips
- 8P6C/RJ-45 6P6C/RJ-12 6P4C/RJ-11
- 4P4C 4P2C PLUGS

ITEM NO.	SIZE		
HTP1141	170mm,7"	10	50



Industrial

## WIRE ROPE CUTTER

- Cr-V drop forged
- Fine polished
- Packing: slide card

ITEM NO.	SIZE		
HTP1142	200mm,8"	6	60



Industrial

## CABLE CUTTER

- Cr-V fine polished
- Bi-color dipped handle
- Packing: slide card

ITEM NO.	SIZE		
HTP1143	150mm,6"	6	60
HTP1144	200mm,8"	6	60



Industrial

## STEEL HEAVY DUTY CABLE CUTTER

- Cr-V fine polished
- Bi-color dipped handle
- Packing: slide card

ITEM NO.	SIZE		
HTP1145	250mm,10"	6	60



Industrial

## CABLE CUTTER

- Joint arms drop-forged
- Used for cutting copper and aluminum cable
- Packing: tie on card

ITEM NO.	SIZE		
HTP1146	18"	1	12



Industrial

## CABLE CUTTER

- Joint arms drop-forged
- Used for cutting copper and aluminum cable
- Packing: tie on card

ITEM NO.	SIZE		
HTP1146	24"	1	5



HAND TOOLS

POWER TOOL ACCESSORIES

CAR TOOLS

POWER TOOLS

AIR TOOLS

GARDEN TOOLS

Industrial



**HEAVY DUTY AMERICAN TYPE PIPE WRENCH**

- Mobile jaw drop-forged with high quality Cr-V steel
- Dipped handle
- Packed: color flag label

ITEM NO.	SIZE	📦	🔧
HTW1000	250mm,10"	6	48
HTW1001	300mm,12"	6	36
HTW1002	350mm,14"	6	24
HTW1003	450mm,18"	2	12
HTW1004	600mm,24"	2	6
HTW1005	900mm,36"	1	4

Industrial



**ALUMINUM HANDLE STRAIGHT PIPE WRENCH**

- Mobile jaw drop-forged with Cr-V steel
- Packed: color flag label

ITEM NO.	SIZE	📦	🔧
HTW1006	250mm,10"	1	24
HTW1007	300mm,12"	1	18
HTW1008	350mm,14"	1	12
HTW1009	450mm,18"	1	6
HTW1010	600mm,24"	1	4
HTW1011	900mm,36"	1	2
HTW1012	1200mm,48"	1	2

Industrial



**OFFSET PIPE WRENCH**

- Mobile jaw drop-forged with high quality Cr-V steel
- Packed: color flag label

ITEM NO.	SIZE	📦	🔧
HTW1014	250mm,10"	1	24
HTW1015	300mm,12"	1	18
HTW1016	350mm,14"	1	12
HTW1017	450mm,18"	1	6
HTW1018	600mm,24"	1	4
HTW1019	900mm,36"	1	2

Industrial



**RATCHET PIPE WRENCH**

- Mobile: 45° CARBON STEEL
- Packed: hang tag

ITEM NO.	SIZE	📦	🔧
HTW1020	450mm,18"	16	
HTW1021	600mm,24"	10	
HTW1022	710mm,28"	10	



**90° BENT NOSE SWEDISH PIPE WRENCH**

- Mobile jaw drop forged with high quality Cr-V steel
- Packed: color box

ITEM NO.	SIZE	📦	🔧
HTW1023	1"	1	36
HTW1024	1.5"	1	24
HTW1025	2"	1	12



**45° BENT NOSE SWEDISH PIPE WRENCH**

- Mobile: 45° CARBON STEEL
- Packed: color box

ITEM NO.	SIZE	📦	🔧
HTW1026	1"	1	36
HTW1027	1.5"	1	24
HTW1028	2"	1	12

Industrial



**CHAIN PIPE WRENCH**

- Jaw Cr-V drop forged
- Jaw teeth induction quenched for durable using
- Dual side jaw for easy change
- Used for pipe construction, oil-field production and drilling operation
- Packed: hang tag

ITEM NO.	SIZE	📦	🔧
HTW1029	4"	1	4
HTW1030	6"	1	2
HTW1031	8"	1	2
HTW1032	10"	1	2
HTW1033	12"	1	2
HTW1034	16"	1	1

HAND TOOLS

POWER TOOL ACCESSORIES

CAR TOOLS

POWER TOOLS

AIR TOOLS

GARDEN TOOLS



## HAND RIVETER

- Hardened steel body
- Applicable rivet: 2.4mm(3/32"), 3.2mm(1/8"), 4.0mm(5/32"), 4.8mm(3/16")
- Supplied nozzle wrench
- Suitable for aluminum rivets
- Packed: double blister

ITEM NO.	SIZE		
HTR1000	250mm, 10"	6	24



Industrial

## ALUMINUM HAND RIVETER

- Aluminum body
- Applicable rivets: 2.4mm(3/32"), 3.2mm(1/8"), 4.0mm(5/32"), 4.8mm(3/16")
- Supplied nozzle wrench
- Suitable for aluminum rivets
- Packed: double blister

ITEM NO.	SIZE		
HTR1002	250mm, 10"	6	24



Industrial

## HEAVY DUTY HAND RIVETER ROTATE HEAD

- Aluminum alloy body, rotating 360°
- Applicable rivets: 2.4mm(3/32"), 3.2mm(1/8"), 4.0mm(5/32"), 4.8mm(3/16")
- Supplied nozzle wrench
- Suitable for aluminum rivets
- Packed: double blister

ITEM NO.	SIZE		
HTR1004	300mm, 12"	6	24



Industrial

## HEAVY DUTY PROFESSIONAL HAND RIVETER

- Aluminum alloy body
- Applicable rivets: 2.4mm(3/32"), 3.2mm(1/8"), 4.0mm(5/32"), 4.8mm(3/16")
- Supplied nozzle wrench
- Suitable for aluminum rivets
- Packed: color box

ITEM NO.	SIZE		
HTR1006	225mm, 11"	1	20



## HAND RIVETER WITH 60PCS RIVETS

- Hardened steel body
- Suitable rivets: 2.4x20PCS-3.2x20PCS-4.0x10PCS-4.8MMx10PCS
- Supplied nozzle wrench
- Suitable for aluminum rivets
- Packed: double blister

ITEM NO.	SIZE		
HTR1001	250mm, 10"	6	12



Industrial

## HEAVY DUTY HAND RIVETER

- Hardened steel body
- Applicable rivets: 2.4mm(3/32"), 3.2mm(1/8"), 4.0mm(5/32"), 4.8mm(3/16")
- PVC Handle
- Packed: slide card

ITEM NO.	SIZE		
HTR1003	250mm, 10"	6	24



Industrial

## PROFESSIONAL HAND RIVETER

- Aluminum alloy body
- Applicable rivets: 2.4mm(3/32"), 3.2mm(1/8"), 4.0mm(5/32"), 4.8mm(3/16")
- Suitable for aluminum rivets
- Packed: double blister

ITEM NO.	SIZE		
HTR1005	200mm, 8"	5	30



## HEAVY DUTY HAND RIVETER

- Aluminum alloy body
- Applicable rivets: 2.4mm(3/32"), 3.2mm(1/8"), 4.0mm(5/32"), 4.8mm(3/16")
- Supplied nozzle wrench
- Suitable for aluminum rivets
- Packed: color box

ITEM NO.	SIZE		
HTR1007	430mm, 17"	1	20



## HEAVY DUTY FOLDING HAND RIVETER

- Aluminum alloy head and handle
- Applicable rivet: 3.2mm(1/8"), 4.0mm(5/32"), 4.8mm(3/16"), 6.0mm(15/64"), 6.4mm(1/4")
- Packed: color box

ITEM NO.	SIZE		
HTR1008	800mm, 32"	2	12



## HAND RIVET

- Aluminum alloy body
- Applicable rivets: 2.4mm(3/32"), 3.2mm(1/8"), 4.0mm(5/32"), 4.8mm(3/16"), 6.0mm(15/64"), 6.4mm(1/4")
- Packed by PVC box

ITEM NO.	SIZE		
HTR1009	2.4mm, 3/32"		2000
HTR1010	3.2mm, 1/8"		2000
HTR1011	4.0mm, 5/32"		2000
HTR1012	4.8mm, 3/16"		2000
HTR1013	6.0mm, 15/64"		2000
HTR1014	6.4mm, 1/4"		2000

HAND TOOLS

POWER TOOL ACCESSORIES

CAR TOOLS

POWER TOOLS

AIR TOOLS

GARDEN TOOLS



## STAPLE GUN

- Surface: chrome coated
- Compatible staples: rapid 530, arrow j121
- With 100pcs nails
- Packed: double blister

ITEM NO.	SIZE		
HTR2000	4-8mm(5/32"-5/16")	10	40



## HEAVY DUTY 3 WAY STAPLE GUN

- Surface: chrome coated
- With 200pcs each for crown, U-shape, brad nails
- Compatible staples: rapid 140, arrow T50, arrow T18, rapid 28, esco 300
- Packed: double blister

ITEM NO.	SIZE		
HTR2001	4-14mm(5/32"-9/16")	6	24



## HEAVY DUTY STAPLE GUN

- Surface: chrome coated
- With 1000pcs crown nails
- Packed: double blister

ITEM NO.	SIZE		
HTR2002	4-14mm(9/16")	5	20



## HAMMER TACKER

- All steel construction with high carbon hardened steel parts
- Single-handed ergonomic grip for easy operation
- 6-14mm (1/4"-9/16")
- Packed: half double blister

ITEM NO.	SIZE		
HTR2003	6-14mm(1/4"-9/16")	5	10



## STAPLE NAIL

- Hand staple nail
- 1000pcs packed in a color box

ITEM NO.	SIZE		
HTR2004	11.2x1.2x6mm		200
HTR2005	11.2x1.2x8mm		160
HTR2006	11.2x1.2x10mm		120
HTR2007	11.2x1.2x12mm		120
HTR2008	11.2x1.2x14mm		120
HTR2009	1.2x10mm		200
HTR2010	1.2x12mm		160
HTR2011	1.2x14mm		160
HTR2012	6x1.2x12mm		160
HTR2014	11.2x0.75x6mm		200
HTR2015	11.2x0.75x8mm		200
HTR2015	11.2x0.75x10mm		200
HTR2016	11.2x0.75x12mm		200
HTR2017	11.2x0.75x14mm		200

- Air nail
- 5000pcs packed in a color box

ITEM NO.	SIZE		
HTR2018	5x1.2x6mm		24
HTR2019	5x1.2x8mm		24
HTR2020	5x1.2x10mm		24
HTR2021	5x1.2x13mm		24
HTR2022	5x1.2x16mm		24
HTR2023	5x1.2x19mm		18
HTR2024	5x1.2x22mm		18
HTR2025	11.2x1.2x6mm		24
HTR2026	11.2x1.2x8mm		24
HTR2027	11.2x1.2x10mm		24
HTR2028	11.2x1.2x13mm		24
HTR2029	11.2x1.2x16mm		20
HTR2030	11.2x1.2x19mm		20
HTR2031	11.2x1.2x22mm		15

- Air nail
- 5000pcs packed in a color box

ITEM NO.	SIZE		
HTR2032	1.25x10mm		40
HTR2033	1.25x15mm		20
HTR2034	1.25x20mm		20
HTR2035	1.25x25mm		20
HTR2036	1.25x30mm		20



# Hand Tools - Padlock



## BRASS NUMBER PAD LOCK

- Material: brass
- Hardened steel shackle
- Double bolted
- Three number
- Packed: double blister

ITEM NO.	SIZE	🔑	📦
HTL1000	20mm		144



## BRASS PADLOCK

- Material: brass
- Hardened steel shackle
- Double bolted
- With 3pcs brass keys
- Packed: double blister

ITEM NO.	SIZE	🔑	📦
HTL1001	20mm		120
HTL1002	30mm		120
HTL1003	40mm		60
HTL1004	50mm		48
HTL1005	60mm		36



## IRON PADLOCK

- Material: iron
- With 3pcs brass keys
- Brass lock cylinder
- Double bolted
- Packed: color box

ITEM NO.	SIZE	🔑	📦
HTL1006	32mm		144
HTL1007	38mm		144
HTL1008	50mm		96
HTL1009	63mm		72



## BRASS BLOCK LOCK

- Material: brass
- Hardened steel shackle
- With 3pcs brass keys
- Packed: double blister

ITEM NO.	SIZE	🔑	📦
HTL1010	60mm		36
HTL1011	70mm		36
HTL1012	80mm		36
HTL1014	90mm		36



## NUMBER PADLOCK

- Hardened steel shackle
- Double bolted
- Packed: double blister

ITEM NO.	SIZE	🔑	📦
HTL1015	40mm	24	72
HTL1016	50mm	24	72



## LAMINATED STEEL PADLOCK

- Material: hardened steel
- With 2pcs brass keys
- Brass lock cylinder
- With waterproof rubber cover
- Packed: double blister

ITEM NO.	SIZE	🔑	📦
HTL1017	30mm	12	144
HTL1018	40mm	12	96
HTL1019	50mm	12	48



## LAMINATED LONG SHACKLE PADLOCK

- Material: hardened steel
- With 2pcs brass keys
- Brass lock cylinder
- With waterproof rubber cover
- Packed: double blister

ITEM NO.	SIZE	🔑	📦
HTL1020	30mm	12	144
HTL1021	40mm	12	96
HTL1022	50mm	12	48



## UNIVERSAL KEY

- Material: zinc alloyed
- Nickel plated
- 1.0x7mm +PH2
- Packed: double blister

ITEM NO.	SIZE	🔑	📦
HTL1023			144



## HEAVY DUTY SQUARE LINK SECURITY CHAIN LOCK

- Material: steel
- With 2pcs keys
- Zinc alloy lock cylinder
- Packed: color card

ITEM NO.	SIZE	🔑	📦
HTL1024	10x900mm		6
HTL1025	12x900mm		6
HTL1026	10x1000mm		6



## BICYCLE CABLE LOCK WITH PVC COATING

- Material: steel wire
- With 2pcs keys
- Zinc alloy lock cylinder
- Packed: color card

ITEM NO.	SIZE	🔑	📦
HTL1027	12x1000mm		60
HTL1028	15x800mm		36
HTL1029	15x1000mm		36



## BICYCLE CABLE LOCK WITH PVC COATING

- Material: steel wire
- With 2pcs keys
- Zinc alloy lock cylinder
- Packed: color card

ITEM NO.	SIZE	🔑	📦
HTL1030	10x1000mm		60
HTL1031	10x1200mm		60
HTL1032	12x1000mm		60



## BICYCLE JOINT LOCK WITH PVC COATING

- Material: steel
- With 2pcs keys
- Zinc alloy lock cylinder
- Packed: color card

ITEM NO.	SIZE	🔑	📦
HTL1033	18x1000mm		24
HTL1034	18x1200mm		24
HTL1035	18x1500mm		24



## COMBINATION SPANNER

- Cr-V
- Chrome plated, satin finish
- Packed: PP card hanger

ITEM NO.	SIZE	SP	OP
HTW2001	6mm	360	
HTW2002	7mm	360	
HTW2003	8mm	360	
HTW2004	9mm	360	
HTW2005	10mm	300	
HTW2006	11mm	240	
HTW2007	12mm	240	
HTW2008	13mm	180	
HTW2009	14mm	120	
HTW2010	15mm	120	
HTW2011	16mm	120	
HTW2012	17mm	90	
HTW2013	18mm	90	
HTW2014	19mm	90	
HTW2015	20mm	90	
HTW2016	21mm	60	
HTW2017	22mm	60	
HTW2018	23mm	60	
HTW2019	24mm	48	
HTW2020	25mm	48	
HTW2021	26mm	48	
HTW2022	27mm	48	
HTW2023	28mm	30	
HTW2024	29mm	30	
HTW2025	30mm	30	
HTW2026	32mm	30	



## DOUBLE OPEN END SPANNER

- Cr-V
- Chrome plated, satin finish
- Packed: PP card hanger

ITEM NO.	SIZE	SP	OP
HTW2027	6x7mm	360	
HTW2028	8x9mm	360	
HTW2029	10x11mm	240	
HTW2030	12x13mm	240	
HTW2031	14x15mm	120	
HTW2032	16x17mm	120	
HTW2033	18x19mm	60	
HTW2034	20x22mm	60	
HTW2035	21x23mm	60	
HTW2036	24x27mm	30	
HTW2037	25x28mm	30	
HTW2038	30x32mm	30	



## DOUBLE OFFSET RING SPANNER

- Cr-V
- Chrome plated, satin finish
- Packed: PP card hanger

ITEM NO.	SIZE	SP	OP
HTW2039	6x7mm	360	
HTW2040	8x9mm	360	
HTW2041	10x11mm	240	
HTW2042	12x13mm	240	
HTW2043	14x15mm	120	
HTW2044	16x17mm	120	
HTW2045	18x19mm	60	
HTW2046	20x22mm	60	
HTW2047	21x23mm	60	
HTW2048	24x27mm	30	
HTW2049	25x28mm	30	
HTW2050	30x32mm	30	

HAND TOOLS

POWER TOOL ACCESSORIES

CAR TOOLS

POWER TOOLS

AIR TOOLS

GARDEN TOOLS



## 6PCS COMBINATION SPANNER SET

- Cr-V
- Chrome plated, satin finish
- Packed: tool bag

ITEM NO.	SIZE	SP	OP
HTW2051	6, 8, 10, 12, 14, 17mm	12	



## 8PCS COMBINATION SPANNER SET

- Cr-V
- Chrome plated, satin finish
- Packed: tool bag

ITEM NO.	SIZE	SP	OP
HTW2052	8,9,10,12,13,14,15,17mm	12	

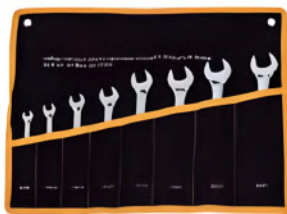

## 8PCS DOUBLE OPEN END SPANNER SET

- Cr-V
- Chrome plated, satin finish
- Packed: tool bag

ITEM NO.	SIZE	SP	OP
HTW2053	6x7, 8x9, 10x11, 12x13, 14x15, 16x17, 18x19, 20x22mm	12	



## 8PCS COMBINATION SPANNER SET

- Cr-V
- Chrome plated, satin finish
- Packed: tool bag

ITEM NO.	SIZE	SP	OP
HTW2054	6x7, 8x9, 10x11, 12x13, 14x15, 16x17, 18x19, 20x22mm	12	



## 8PCS DOUBLE OFFSET RING SPANNER SET

- Cr-V
- Chrome plated, satin finish
- Packed: tool bag

ITEM NO.	SIZE	SP	OP
HTW2055	6x7, 8x9, 10x11, 12x13, 14x15, 16x17, 18x19, 20x22mm	12	



# Hand Tools - Wrench



## 12PCS DOUBLE OPEN END SPANNER SET

- Cr-V
- Chrome plated, satin finish
- Packed: tool bag

ITEM NO.	SIZE	📦	🔪
HTW2056	6x7, 8x9, 10x11, 12x13, 14x15, 16x17, 18x19, 20x22, 21x23, 24x27, 25x28, 30x32mm	6	



## 12PCS COMBINATION SPANNER SET

- Cr-V
- Chrome plated, satin finish
- Packed: tool bag

ITEM NO.	SIZE	📦	🔪
HTW2057	8, 10, 11, 12, 13, 14, 15, 16, 17, 18, 19, 22mm	6	



## 12PCS DOUBLE OFFSET RING SPANNER SET

- Cr-V
- Chrome plated, satin finish
- Packed: tool bag

ITEM NO.	SIZE	📦	🔪
HTW2058	6x7, 8x9, 10x11, 12x13, 14x15, 16x17, 18x19, 20x22, 21x23, 24x27, 25x28, 30x32mm	6	



## FLARE NUT SPANNER

- Cr-V
- Chrome plated finish
- Packed: plastic hanger

ITEM NO.	SIZE	📦	🔪
HTW2059	6x8mm	60	
HTW2060	9x11mm	60	
HTW2061	10x12mm	60	
HTW2062	12x14mm	60	
HTW2063	15x17mm	60	
HTW2064	16x18mm	60	
HTW2065	19x22mm	60	



## 6PCS FLARE NUT SPANNER SET

- Cr-V
- Chrome plated, satin finish
- Packed: tool bag

ITEM NO.	SIZE	📦	🔪
HTW2066	6x8, 9x11, 10x12, 13x14, 15x17, 16x18, 19x22mm	12	



## 6PCS FLARE NUT SPANNER SET

- Cr-V
- Chrome plated, satin finish
- Packed: plastic holder

ITEM NO.	SIZE	📦	🔪
HTW2067	6x8, 9x11, 10x12, 13x14, 15x17, 16x18mm	12	



## FIXED COMBINATION RATCHET SPANNER

- Cr-V
- Chrome plated, satin finish
- Packed: plastic hanger

ITEM NO.	SIZE	📦	🔪
HTW2068	8mm	120	
HTW2069	9mm	120	
HTW2070	10mm	120	
HTW2071	11mm	120	
HTW2072	12mm	120	
HTW2073	13mm	120	
HTW2074	14mm	120	
HTW2075	15mm	60	
HTW2076	16mm	60	
HTW2077	17mm	60	
HTW2078	18mm	60	
HTW2079	19mm	60	
HTW2080	20mm	60	
HTW2081	21mm	60	
HTW2082	22mm	60	
HTW2083	23mm	48	
HTW2084	24mm	48	
HTW2085	25mm	48	
HTW2086	27mm	30	
HTW2087	30mm	24	
HTW2088	32mm	24	

## FLEXIBLE COMBINATION RATCHET SPANNER

- Cr-V
- Chrome plated, satin finish
- Packed: plastic hanger

ITEM NO.	SIZE	📦	🔪
HTW2089	8mm	120	
HTW2090	9mm	120	
HTW2091	10mm	120	
HTW2092	11mm	120	
HTW2093	12mm	120	
HTW2094	13mm	120	
HTW2095	14mm	120	
HTW2096	15mm	60	
HTW2097	16mm	60	
HTW2098	17mm	60	
HTW2099	18mm	60	
HTW2100	19mm	60	
HTW2101	20mm	60	
HTW2102	21mm	60	
HTW2103	22mm	60	
HTW2104	23mm	48	
HTW2105	24mm	48	
HTW2106	25mm	48	
HTW2107	27mm	30	
HTW2108	30mm	24	
HTW2109	32mm	24	

## 5PCS FIXED COMBINATION RATCHET SPANNER SET

- Cr-V
- Chrome plated, satin finish
- Packed: plastic holder

ITEM NO.	SIZE	📦	🔪
HTW2110	8, 12, 13, 14, 17mm	24	



### 5PCS FIXED COMBINATION RATCHET SPANNER SET

- Cr-V
- Chrome plated, satin finish
- Packed: plastic holder

ITEM NO.	SIZE	📦	🔧
HTW2111	8,12,13,14,17mm	6	20



### ADJUSTABLE WRENCH

- High carbon steel drop-forged body
- Hardened chrome plated satin finish
- Packed: plastic hanger+color sticker

ITEM NO.	SIZE	📦	🔧
HTW2115	150mm,6"	6	120
HTW2116	200mm,8"	6	60
HTW2117	250mm,10"	6	48
HTW2118	300mm, 12"	6	24
HTW2119	375mm, 15"	4	12
HTW2120	450mm,18"	6	6
HTW2121	600mm,24"	4	4



### 7PCS FLEXIBLE COMBINATION RATCHET SPANNER SET

- Cr-V
- Chrome plated, satin finish
- Packed: plastic holder

ITEM NO.	SIZE	📦	🔧
HTW2112	8, 10, 12, 13, 14, 17, 19mm	6	12



### ADJUSTABLE WRENCH

- High carbon steel drop-forged body
- Surface phosphating
- Packed: plastic hanger+color sticker

ITEM NO.	SIZE	📦	🔧
HTW2122	150mm,6"	6	120
HTW2123	200mm,8"	6	60
HTW2124	250mm,10"	6	48
HTW2125	300mm, 12"	6	24
HTW2126	375mm, 15"	4	12



### 7PCS FIXED COMBINATION RATCHET SPANNER SET

- Cr-V
- Chrome plated, satin finish
- Packed: plastic holder

ITEM NO.	SIZE	📦	🔧
HTW2114	8, 10, 12, 13, 14, 17, 19mm	6	12



### ADJUSTABLE WRENCH

- High carbon steel drop-forged body
- Hardened nickle plated finish
- Packed: plastic hanger+color sticker

ITEM NO.	SIZE	📦	🔧
HTW2127	150mm,6"	6	120
HTW2128	200mm,8"	6	60
HTW2129	250mm,10"	6	48
HTW2130	300mm, 12"	6	24



### 3PCS ADJUSTABLE WRENCH SET

- High carbon steel drop-forged body
- Hardened chrome plated satin finish
- Size: 150mm(6"), 200mm(8"), 250mm(10")
- Packed: slide card

ITEM NO.	SIZE	📦	🔧
HTW2135	3pcs	6	12



### ADJUSTABLE WRENCH

- Cr-V steel drop-forged body
- Hardened nickle finish
- Bi-color PVC soft grip
- Packed: plastic hanger+color sticker

ITEM NO.	SIZE	📦	🔧
HTW2131	150mm,6"	6	120
HTW2132	200mm,8"	6	96
HTW2133	250mm,10"	6	60
HTW2134	300mm, 12"	6	36



### ADJUSTABLE WRENCH

- Cr-V steel drop-forged body
- Hardened nickle finish
- Bi-color PVC soft grip
- Packed: plastic hanger+color sticker

ITEM NO.	SIZE	📦	🔧
HTW2131	150mm,6"	6	120
HTW2132	200mm,8"	6	60
HTW2133	250mm,10"	6	48
HTW2134	300mm, 12"	6	24

HAND TOOLS

POWER TOOL ACCESSORIES

CAR TOOLS

POWER TOOLS

AIR TOOLS

GARDEN TOOLS

# Hand Tools - Wrench



## T TYPE SOCKET WRENCH

- Rubber Handle
- Material: High quality carbon steel drop forged heat treatment satin finished, chrome plated
- Packed: tie on card

ITEM NO.	SIZE	📦	📄
HTW3000	8mm	10	60
HTW3001	9mm	10	60
HTW3002	10mm	10	60
HTW3003	11mm	10	60
HTW3004	12mm	10	60
HTW3005	13mm	10	60
HTW3006	14mm	10	60
HTW3007	15mm	10	60
HTW3008	16mm	10	60
HTW3009	17mm	10	60



## CROSS RIM WRENCH

- Chrome finish
- Cross design provides extra leverage and torque
- Socket site 17-19-21-23mm
- Packed: plastic hanger

ITEM NO.	SIZE	📦	📄
HTW3010	355mm/14"	20	
HTW3011	450mm/18"	12	



## FOLDABLE CROSS RIM WRENCH

- Chrome finish
- Cross design provides extra leverage and torque
- Socket site 17-19-21-23mm
- Packed: tie on card

ITEM NO.	SIZE	📦	📄
HTW3012	355mm/14"	20	



Industrial

## CONSTRUCTION RATCHET WRENCH

- Drop Forged Handle
- Chrome Vanadium Steel
- The Socket Hardened and Tempered
- Packed: color box

ITEM NO.	SIZE	📦	📄
HTW3014	10x12mm	70	
HTW3015	11x13mm	70	
HTW3016	12x14mm	70	
HTW3017	13x17mm	50	
HTW3018	14x17mm	50	
HTW3019	17x19mm	40	
HTW3020	17x21mm	40	
HTW3021	19x21mm	40	
HTW3022	19x24mm	24	
HTW3023	21x26mm	24	
HTW3024	21x27mm	24	
HTW3025	22x24mm	24	
HTW3026	24x27mm	24	
HTW3027	24x30mm	16	
HTW3028	32x36mm	12	



Industrial

## DOUBLE FLEXIBLE SOCKET WRENCH

- Cr-V steel
- Mirror polish satin finish
- Packed: plastic hanger

ITEM NO.	SIZE	📦	📄
HTW3029	8x9mm	200	
HTW3030	8x10mm	200	
HTW3031	10x11mm	200	
HTW3032	10x12mm	200	
HTW3033	12x13mm	150	
HTW3034	12x14mm	150	
HTW3035	14x15mm	100	
HTW3036	14x17mm	100	
HTW3037	16x17mm	80	
HTW3038	17x19mm	60	
HTW3039	18x19mm	60	
HTW3040	20x22mm	40	
HTW3041	21x23mm	40	



Industrial

## COMBINATION FLEXIBLE SOCKET WRENCH

- Cr-V Steel
- Mirror polish, satin finish
- Packed: plastic hanger

ITEM NO.	SIZE	📦	📄
HTW3042	8mm	300	
HTW3043	9mm	300	
HTW3044	10mm	250	
HTW3045	11mm	250	
HTW3046	12mm	200	
HTW3047	13mm	200	
HTW3048	14mm	150	
HTW3049	15mm	150	
HTW3050	16mm	100	
HTW3051	17mm	100	
HTW3052	18mm	100	
HTW3053	19mm	100	
HTW3054	20mm	80	
HTW3055	21mm	50	
HTW3056	22mm	50	
HTW3057	23mm	40	
HTW3058	24mm	40	



## 2PCS UNIVERSAL SPANNER SET

- Chrome finish
- Bi-color plastic handle
- Size: 9-22mm, 23-32mm
- Packed: slide card

ITEM NO.	SIZE	📦	📄
HTW3059	2pcs	15	30



## 8 IN 1 SOCKET WRENCH

- Cr-V steel
- Mirror polish
- Size: 12, 13, 14, 15, 16, 17, 18, 19mm
- Packed: tie on card

ITEM NO.	SIZE	📦	📄
HTW3060	8 in 1	24	



**L-TYPE SOCKET WRENCH**

- Cr-V
- Chrome plated, satin finish
- Packed: paper hanger

ITEM NO.	SIZE		
HTW3061	6mm	12	144
HTW3062	7mm	12	144
HTW3063	8mm	12	144
HTW3064	9mm	12	144
HTW3065	10mm	12	144
HTW3066	11mm	12	144
HTW3067	12mm	12	120
HTW3068	13mm	12	120
HTW3069	14mm	12	96
HTW3070	15mm	12	96
HTW3071	16mm	12	72
HTW3072	17mm	12	72
HTW3073	18mm	12	48
HTW3074	19mm	12	48
HTW3075	20mm	6	36
HTW3076	21mm	6	36
HTW3077	22mm	6	24
HTW3078	23mm	6	24
HTW3079	24mm	6	12
HTW3080	35mm	6	12
HTW3081	36mm	6	12
HTW3082	27mm	6	12
HTW3083	28mm	6	12
HTW3084	30mm	6	12
HTW3085	32mm	6	12



**RATCHET HANDLE (72 TEETH)**

- Cr-Mo
- Satin finish
- Triple-color plastic handle
- Packed: plastic hanger

ITEM NO.	SIZE		
HTW3086	1/4"	10	50
HTW3087	3/8"	5	30
HTW3088	1/2"	5	20



**RATCHET HANDLE (24 TEETH)**

- Cr-V
- Satin finish
- Bi-color plastic handle
- Packed: plastic hanger

ITEM NO.	SIZE		
HTW3089	1/4"	10	100
HTW3090	3/8"	10	60
HTW3091	1/2"	10	30

HAND TOOLS

POWER TOOL ACCESSORIES

CAR TOOLS

POWER TOOLS

AIR TOOLS

GARDEN TOOLS



**RATCHET HANDLE (45 TEETH)**

- Cr-V
- Packed: plastic hanger
- Chrome-plated finish

ITEM NO.	SIZE		
HTW3092	1/4"		60
HTW3093	3/8"		48
HTW3094	1/2"		36

**TORQUE WRENCH**

- Cr-V
- Mirror polish
- Packed: BMC

ITEM NO.	SIZE		
HTW3095	1/4" 5-25N.m		50
HTW3096	3/8" 20-110N.m		25
HTW3097	1/2" 28-210N.m		12
HTW3098	3/4" 60-330N.m		6



**6PCS L-TYPE SOCKET WRENCH SET**

- Cr-V
- Chrome plated satin finished
- Size: 8, 10, 12, 13, 17, 19mm
- Packed: plastic hanger

ITEM NO.	SIZE		
HTW3099	6pcs	2	10



**3PCS EXTENDING WHEEL NUT WRENCH**

- Plated telescope handle
- 2pc reversible socket: 17x19mm&21x23mm
- Packed: slide card

ITEM NO.	SIZE		
HTW3100	17/19/21/23mm		20

# Hand Tools - Socket Wrench



## SOCKET

- 1/4" 3/8" 1/2"
- Size in metric / inch
- Cr-V
- Satin finish, Chrome-coated
- Mirror polished
- Packed: 10pcs in color box

inch site

- 1/4": 5/32, 3/16, 7/32, 1/4, 9/32, 5/16, 11/32, 3/8, 7/16, 1/2, 9/16
- 3/8": 5/16, 11/32, 3/8, 7/16, 1/2, 9/16, 5/8, 11/16, 3/4, 13/16, 3/4, 13/16, 7/8, 15/16
- 1/2": 3/8, 7/16, 1/2, 9/16, 19/32, 5/8, 11/16, 3/4, 13/16, 7/8, 15/16, 1, 1-1/16, 1-1/8, 1-3/16, 1-1/4



ITEM NO.	SIZE	Cr-V	Cr-V
HTSW1001	1/4"-4mm	10	120
HTSW1002	1/4"-4.5mm	10	120
HTSW1003	1/4"-5mm	10	120
HTSW1004	1/4"-5.5mm	10	120
HTSW1005	1/4"-6mm	10	120
HTSW1006	1/4"-7mm	10	120
HTSW1007	1/4"-8mm	10	120
HTSW1008	1/4"-9mm	10	120
HTSW1009	1/4"-10mm	10	120
HTSW1010	1/4"-11mm	10	120
HTSW1011	1/4"-12mm	10	120
HTSW1012	1/4"-13mm	10	120
HTSW1013	1/4"-14mm	10	120
HTSW1014	3/8"-8mm	10	120
HTSW1015	3/8"-9mm	10	120
HTSW1016	3/8"-10mm	10	120
HTSW1017	3/8"-11mm	10	120
HTSW1018	3/8"-12mm	10	120
HTSW1019	3/8"-13mm	10	120
HTSW1020	3/8"-14mm	10	120
HTSW1021	3/8"-15mm	10	120
HTSW1022	3/8"-16mm	10	120
HTSW1023	3/8"-17mm	10	120
HTSW1024	3/8"-18mm	10	120
HTSW1025	3/8"-19mm	10	60
HTSW1026	3/8"-20mm	10	60
HTSW1027	3/8"-21mm	10	60
HTSW1028	3/8"-22mm	10	60
HTSW1029	3/8"-23mm	10	60
HTSW1030	3/8"-24mm	10	60
HTSW1031	1/2"-8mm	10	120
HTSW1032	1/2"-9mm	10	120
HTSW1033	1/2"-10mm	10	120
HTSW1034	1/2"-11mm	10	120
HTSW1035	1/2"-12mm	10	120
HTSW1036	1/2"-13mm	10	120
HTSW1037	1/2"-14mm	10	120
HTSW1038	1/2"-15mm	10	120
HTSW1039	1/2"-16mm	10	120
HTSW1040	1/2"-17mm	10	120
HTSW1041	1/2"-18mm	10	120
HTSW1042	1/2"-19mm	10	60
HTSW1043	1/2"-20mm	10	60
HTSW1044	1/2"-21mm	10	60
HTSW1045	1/2"-22mm	10	60
HTSW1046	1/2"-23mm	10	60
HTSW1047	1/2"-24mm	10	60
HTSW1048	1/2"-27mm	10	60
HTSW1049	1/2"-30mm	10	60
HTSW1050	1/2"-32mm	10	60



## DEEP SOCKET

- 1/4" 3/8" 1/2"
- Size in metric / inch
- Cr-V
- Satin finish, Chrome-coated
- Mirror polished
- Packed: 10pcs in color box

inch site

- 1/4": 5/32, 3/16, 7/32, 1/4, 9/32, 5/16, 11/32, 3/8, 7/16, 1/2, 9/16
- 3/8": 5/16, 11/32, 3/8, 7/16, 1/2, 9/16, 5/8, 11/16, 3/4, 13/16, 3/4, 13/16, 7/8, 15/16
- 1/2": 3/8, 7/16, 1/2, 9/16, 19/32, 5/8, 11/16, 3/4, 13/16, 7/8, 15/16, 1, 1-1/16, 1-1/8, 1-3/16, 1-1/4



ITEM NO.	SIZE	Cr-V	Cr-V
HTSW1051	1/4"-4mm	10	120
HTSW1052	1/4"-4.5mm	10	120
HTSW1053	1/4"-5mm	10	120
HTSW1054	1/4"-5.5mm	10	120
HTSW1055	1/4"-6mm	10	120
HTSW1056	1/4"-7mm	10	120
HTSW1057	1/4"-8mm	10	120
HTSW1058	1/4"-9mm	10	120
HTSW1059	1/4"-10mm	10	120
HTSW1060	1/4"-11mm	10	120
HTSW1061	1/4"-12mm	10	120
HTSW1062	1/4"-13mm	10	120
HTSW1063	1/4"-14mm	10	120
HTSW1064	3/8"-8mm	10	120
HTSW1065	3/8"-9mm	10	120
HTSW1066	3/8"-10mm	10	120
HTSW1067	3/8"-11mm	10	120
HTSW1068	3/8"-12mm	10	120
HTSW1069	3/8"-13mm	10	120
HTSW1070	3/8"-14mm	10	120
HTSW1071	3/8"-15mm	10	120
HTSW1072	3/8"-16mm	10	120
HTSW1073	3/8"-17mm	10	120
HTSW1074	3/8"-18mm	10	120
HTSW1075	3/8"-19mm	10	60
HTSW1076	3/8"-20mm	10	60
HTSW1077	3/8"-21mm	10	60
HTSW1078	3/8"-22mm	10	60
HTSW1079	3/8"-23mm	10	60
HTSW1080	3/8"-24mm	10	60
HTSW1081	1/2"-8mm	10	120
HTSW1082	1/2"-9mm	10	120
HTSW1083	1/2"-10mm	10	120
HTSW1084	1/2"-11mm	10	120
HTSW1085	1/2"-12mm	10	120
HTSW1086	1/2"-13mm	10	120
HTSW1087	1/2"-14mm	10	120
HTSW1088	1/2"-15mm	10	120
HTSW1089	1/2"-16mm	10	120
HTSW1090	1/2"-17mm	10	120
HTSW1091	1/2"-18mm	10	120
HTSW1092	1/2"-19mm	10	60
HTSW1093	1/2"-20mm	10	60
HTSW1094	1/2"-21mm	10	60
HTSW1095	1/2"-22mm	10	60
HTSW1096	1/2"-23mm	10	60
HTSW1097	1/2"-24mm	10	60
HTSW1098	1/2"-27mm	10	60
HTSW1099	1/2"-30mm	10	60
HTSW1100	1/2"-32mm	10	60



## UNIVERSAL JOINT SOCKET

- Cr-V
- Satin finish
- Chrome coated
- Packed: sliding card

ITEM NO.	SIZE	Cr-V	Cr-V
HTSW1101	1/4"	12	144
HTSW1102	3/8"	12	72
HTSW1103	1/2"	12	48
HTSW1104	3pcs	10	40



## SPARK PLUG SOCKET

- Cr-V
- Satin finish, chrome-coated
- Mirror polished
- Packed: 10pcs in color box



ITEM NO.	SIZE	Cr-V	Cr-V
HTSW1105	16mm, 5/8"	12	144
HTSW1106	21mm, 13/16"	12	72



## 4PCS SWIVEL SPARK PLUG SOCKET SET

- Cr-V
- Satin finish
- Chrome-coated
- Mirror polished
- Socket site: 9/16"(14mm), 5/8"(16mm), 3/4"(9mm), 13/16"(21mm)
- Packed: double blister

ITEM NO.	SIZE	Cr-V	Cr-V
HTSW1107	4pcs, 3/8"	6	24



## 4PCS SOCKET ADAPTOR SET

- Cr-V
- Surface satin finish
- Socket adaptor: 1/4"(F)x3/8"(M), 3/8"(F)x1/2"(M), 3/8"(F)x1/4"(M), 1/2"(F)x3/8"(M)
- Packing: double blister

ITEM NO.	SIZE	Cr-V	Cr-V
HTSW1108	4pcs	6	24



### 3PCS POWER EXTENSION BAR

- Material: Cr-V
- Surface satin finished
- Size: 6mm to 1/4", 3/8", 1/2"
- Packing: slide card

ITEM NO.	SIZE		
HTSW1200	3pcs	12	60



### SLIDING BAR

- Cr-V
- Satin finish, chrome-coated
- Mirror polished
- Packed: tie on card

ITEM NO.	SIZE		
HTSW1205	1/4"x100mm	12	144
HTSW1206	3/8"x150mm	12	72
HTSW1207	1/2"x250mm	12	36



### EXTENSION BAR

- Cr-V
- Satin finish
- Packed: tie on card
- Chrome-coated
- Mirror polished

ITEM NO.	SIZE		
HTSW1210	1/4"x50, 75, 100, 150mm	200	
HTSW1211	3/8"x75, 100, 150mm	100	
HTSW1212	1/2"x75, 125, 150, 200, 250mm	50	



### 4PCS 3/8"DR.EXTENSION BAR

- Material: Cr-V
- Chromed
- Size: 3", 6", 9", 12"
- Packed by Double blister

ITEM NO.	SIZE		
HTSW1201	4pcs	10	60



### L TYPE HANDLE

- Cr-V
- Satin finish
- Packed by tie on card

ITEM NO.	SIZE		
HTSW1203	1/2"x250mm	12	120



### 8PCS 3/8"DR. E TYPE SOCKET WRENCH SET

- Material: Cr-V
- Satin finish
- 3/8" dr.Socket: E4, E5, E6, E7, E8, E10, E12, E14mm
- Packing: slide card

ITEM NO.	SIZE		
HTSW1208	8pcs	10	40



### 9PCS 1/2"DR. E TYPE SOCKET WRENCH SET

- Material: Cr-V
- Satin finish
- 9pcs 1/2" dr. E Type Socket: E10, E11, E12, E14, E16, E18, E20, E22, E24mm
- Packing: slide card

ITEM NO.	SIZE		
HTSW1214	9pcs	5	20



### 10PCS 1/2"DR. SOCKET WRENCH SET

- Material: Cr-V
- Satin finish
- 1/2" dr.socket: 10, 11, 12, 13, 14, 15, 16, 17, 18, 19mm
- Packing: slide card



ITEM NO.	SIZE		
HTSW1202	10pcs	5	20



### 14PCS E TYPE SOCKET WRENCH SET

- Material: Cr-V
- Satin finish
- 5pcs 1/4" dr. E Type Socket: e4, e5, e6, e7, e8
- 5pcs 3/8" dr. E Type Socket: e10, e11, e12, e14, e16
- 4pcs 1/2" dr. E Type Socket: e18, e20, e22, e24
- Packing: slide card

ITEM NO.	SIZE		
HTSW1204	14pcs	5	20



### 9PCS 1/4"DR. DEEP SOCKET WRENCH SET

- Material: Cr-V
- Satin finish
- 1/4" dr.deep Socket: 5,6,7,8,9,10,11,12,13mm
- Packing: slide card



ITEM NO.	SIZE		
HTSW1209	9pcs	5	20



### 9PCS 1/2"DR. DEEP SOCKET WRENCH SET

- Material: Cr-V
- Satin finish
- 1/2" dr. deep Socket: 10, 11, 13, 14, 15, 17, 19, 21, 22mm
- Packing: slide card



ITEM NO.	SIZE		
HTSW1215	9pcs	5	20



## 12PCS 1/2" DR. DEEP SOCKET WRENCH SET



- Material: Cr-V
- Satin finish
- 1/2" dr. deep Socket: 10, 11, 12, 13, 14, 15, 17, 19, 20, 21, 22, 24mm
- Packing: slide card

ITEM NO.	SIZE	📦	🔧
HTSW1216	12pcs	5	20



## 12PCS 1/4" DR. SOCKET WRENCH SET

- 10pcs 1/4" Dr. Socket: 4,5,6,7,8,9,10,11,12,13mm
- 1pc extension bar 100mm
- 1pc 72T ratchet
- Material: handle Cr-V
- Satin finish
- Packing: plastic hanger in double blister

ITEM NO.	SIZE	📦	🔧
HTSW1220	12pcs	5	25



## 12PCS 3/8" DR. SOCKET WRENCH SET

- 10pcs 3/8" Dr. Socket: 10,11,12,13,14,15,17,19,22,24mm
- 1pc extension bar 125mm
- 1pc 72T ratchet
- Material: carbon steel with heat treated
- Satin finish
- Packing: plastic hanger in double blister

ITEM NO.	SIZE	📦	🔧
HTSW1221	12pcs	5	20



## 9PCS TORX BITS SOCKET SET

- Material: Cr-V
- Satin finish
- 1/4" dr. bit Socket: T10, T15, T20, T27, T30, T40, T45, T50, T60
- Packing: slide card

ITEM NO.	SIZE	📦	🔧
HTSW1217	9pcs	10	40



## 12PCS 1/2" DR. SOCKET WRENCH SET

- 10pcs 1/2" Dr. Socket: 10,11,12,13,14,15,17,19,22,24 mm
- 1pc extension bar 125mm
- 1pc 72T ratchet
- Material: Cr-V with heat treated
- Satin finish
- Packing: plastic hanger in double blister

ITEM NO.	SIZE	📦	🔧
HTSW1222	12pcs	5	10



## 20PCS 1/2" DR. SOCKET WRENCH SET

- 18pcs 1/2" Dr. Socket: 8,9,10,11,12,13,14,15,16,17,18, 19,20,22,24,27,30,32mm
- 1pc extension bar 125mm
- 1pc 72T ratchet
- Material: Cr-V with heat treated
- Satin finish
- Packing: plastic hanger in double blister

ITEM NO.	SIZE	📦	🔧
HTSW1223	20pcs	2	8



## 11PCS BITS SOCKET SET

- Material: Cr-V
- Satin finish
- 1/4" dr. bit Socket: H3, H4, H5, H6, H7, PZ1, PZ2, PZ3, PH1, PH2, PH3
- Packing: slide card

ITEM NO.	SIZE	📦	🔧
HTSW1218	11pcs	10	40



## 12PCS TORX BIT SOCKET SET

- Material: Cr-V
- Satin finish
- 6pcs 1/4" dr.bit Socket: T10, T15, T20, T25, T27, T45
- 6pcs 1/2" dr.bit Socket: T30, T40, T45, T50, T55, T60
- Packing: slide card

ITEM NO.	SIZE	📦	🔧
HTSW1219	12pcs	10	40

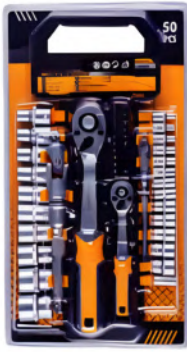

### 50PCS 1/2" & 1/4" DR. SOCKET WRENCH SET

- Cr-V
- 1/4" Drive
- 13pcs 1/4" Socket: 4,4.5,5.5,6,7,8,9,10,11,12,13,14mm
- 1pc ratchet
- 1pc universal joint
- 1pc bit holder
- 20pcs bits
- 1pc extension bar 100mm L
- 1/2" Drive 10pcs
- 1/2" sockets: 10,11,12,13,14,15,17,19,22,24mm
- 1pc extension bar 125mm L
- 1pc ratchet
- 1pc universal joint

ITEM NO.	SIZE		
HTSW1224	50pcs	1	5



### 46PCS 1/4" DR. SOCKET WRENCH SET

- Cr-V
- 13pcs 1/4" Socket: 4,4.5,5.5,6,7,8,9,10,11,12,13,14mm
- 21pcs bits socket
- 1pc universal joint
- 1pc 72T ratchet
- 1pc sliding bar 115mm
- 1pc flexible extension bar 150mm L
- 1pc spinner handle 150mm
- 1pc 30mm hex adaptor
- 2pcs extension bar 50mm&100mm
- 4pcs hex key wrenches 1.27, 1.5, 2, 2.5

ITEM NO.	SIZE		
HTSW1225	46pcs	1	10



### 73PCS 1/4" & 1/2" DR. SOCKET WRENCH SET

- Cr-V
- 1/2" Drive
- 16pcs standard Socket: 10,11,12,13,14,15,16,17,18,19,20,21,22,23,24,27mm
- 1pc universal joint
- 2pcs extension bar: 125mm,250mm
- 1pc 72T ratchet
- 2pc spark plug socket: 16mm, 21mm
- 1pc 3 way adaptor
- 1/4" Drive
- 10pcs standard socket 4,5,5.5,6,7,8,10,11,12,13mm
- 1pc 1/4"x1/4" bits holder
- 1pc spinner handle
- 1pc extension bar: 100mm
- 1pc 72T ratchet
- 3pcs hex key wrenches: 1.5,2,2.5mm
- 33pcs bits 30mm
- T:8, 10, 15, 20, 25, 27, 30, 40 PD:0, 1, 2, 3
- PZ:1, 2, 3 FD:4, 5.5, 7mm M:6,8mm
- Hex:3,4,5,6,8,10mm
- 1/8", 9/64", 5/32", 3/16", 7/32", 1/4", 5/16"

ITEM NO.	SIZE		
HTSW1226	73pcs	1	4



### 94PCS 1/4" & 1/2" DR. SOCKET WRENCH SET

- Cr-V
- 1/2" Drive
- 18pcs Socket: 10,11,12,13,14,15,16,17,18,19,20,21,22,23,24,27,30,32mm
- 4pcs deep Socket 14,15,17,19mm
- 1pc universal joint
- 2pcs extension bar: 125mm,250mm
- 1pc 72T ratchet
- 1pc 3 way adaptor
- 2pcs spark plug socket: 16mm, 21mm
- 1pc 5/16" bits holder
- 15pcs bits 30mm
- TX:40,45,50,55 Hex:8,10,12,14 PH:3,4 PZ:3,4 FD:8,10,12,14
- 1/4" Drive
- 13pcs Socket: 4,4.5,5.5,6,7,8,9,10,11,12,13,14mm
- 8pcs deep Socket: 6,7,8,9,10,11,12,13mm
- 1pc universal joint
- 2pcs extension bar: 50mm,100mm
- 1pc 72T ratchet
- 1pc sliding bar 115mm
- 1pc flexible extension bar 150mm
- 1pc spinner handle 150mm
- 3pcs hex key wrenches 1.5,2,2.5mm
- 1pc 30mm L 1/4" hex bit adaptor
- 17pcs bits socket
- TX:8,10,15,20,25,30 PH:1,2 PZ:1,2 FD:4,5,5.7 Hex:3,4,5

ITEM NO.	SIZE		
HTSW1227	94pcs	1	4



### 171PCS 1/4", 3/8" & 1/2" DR. SOCKET WRENCH SET

- Cr-V
- 1/2" Drive
- 17pcs 6-point Standard Sockets: 10,11,12,13,14,15,16,17,18,19,20,21,22,24,27,30,32mm
- 2pcs E-type Sockets: E20, E24
- 5pcs 6-point Deep Sockets: 15,17,18,19,22mm
- 1pc 72T Ratchet 2pcs Extension Bar: 125mm,250mm
- 1pc Universal Joint 1pc 3 Way Adaptor
- 2pcs Spark Plug Socket: 16mm, 21mm
- 1pc Bits Holder 10mm
- 24pcs 8mm Bits 30mm L
- TX:40,45,50,55 (10mm), 60(10mm), 70(10mm)
- TT:40,45,50,55 (10mm), 60(10mm), 70(10mm)
- PD:3,4 PZ: 3,4 FD:8,10,12mm HEX:7,8,10,12,14mm
- 7pcs Hex Key Wrenches: 1.27,1.5,2,2.5,3,4,5mm
- 3/8" Drive
- 10pcs 6-point Standard Sockets: 10,11,12,13,14,15,16,17,18,19mm
- 8pcs E-type Sockets: E10,E11,E12,E14,E16,E18
- 6pcs 6-point Deep Sockets: 10,11,12,13,14,15mm
- 1pc Spark Plug Socket:18mm
- 1pc Extension Bar: 150mm
- 1pc Universal Joint
- 1pc 72T Ratchet
- 1pc Bit Holder 8mm
- 1/4" Drive
- 13pcs 6-point Standard Sockets: 4,4.5,5.5,6,7,8,9,10,11,12,13,14mm
- 5pcs E-type Sockets: E4,5,6,7,8
- 7pcs 6-point Deep Sockets: 4,5,6,7,8,9,10mm
- 1pc 72T Ratchet
- 2pcs Extension Bar: 50mm, 100mm
- 1pc Spinner Handle 150mm
- 1pc Sliding Bar: 115mm L
- 1pc Universal Joint
- 30pcs Bits Socket
- PH:3,4,5,6mm FD:4,5,5.5,6,7mm
- PD:0,1,2 PZ:0,1,2
- T:8,9,10,15,20,25,27,30
- TT:8,9,10,15,20,25,27,30
- 1pc 1/4"x1/4"bits Holder
- 20pcs Bits

ITEM NO.	SIZE		
HTSW1228	171pcs	1	2



### 110PCS 1/4" & 1/2" DR. SOCKET WRENCH SET

- Cr-V
- 1/2" Drive
- 17pcs Socket: 10,11,12,13,14,15,16,17,18,19,20,21,22,24,27,30,32mm
- 5pcs Deep Socket 14,15,17,19,22mm
- 8pcs E-type Socket: E10,E11,E12,E14,E16,E18,E20,E24
- 1pc Universal Joint
- 2pcs extension bar: 125mm,250mm
- 1pc 72T ratchet
- 1pc 3 way adaptor
- 2pcs spark plug socket: 16mm, 21mm
- 1pc 5/16" bits holder
- 17pcs bits 30mm
- TX:40,45,50,55,60 PH:3,4 PZ:3,4 FD:8,10,12 Hex:7,8,10,12,14
- 1/4" Drive
- 13pcs Socket: 4,4.5,5.5,6,7,8,9,10,11,12,13,14mm
- 8pcs deep Socket: 6,7,8,9,10,11,12,13mm
- 1pc universal joint
- 2pcs extension bar: 50mm,100mm
- 1pc 72T ratchet
- 1pc sliding bar 115mm
- 1pc spinner handle 150mm
- 4pcs hex key wrenches 1.27,1.5,2,2.5mm
- 1pc 30mm L 1/4" hex bit adaptor
- 5pcs E-type socket: E4,E5,E6,E7,E8
- 18pcs bits socket
- TX:8,10,15,20,25,27,30
- PH:1,2 PZ:1,2 FD:4,5,5.7 Hex:3,4,5,6

ITEM NO.	SIZE		
HTSW1229	110pcs	1	4





HAND TOOLS  
POWER TOOL ACCESSORIES  
CAR TOOLS  
POWER TOOLS  
AIR TOOLS  
GARDEN TOOLS



### 24PCS 1/2"DR. SOCKET WRENCH SET

- Contents:
- 18pcs 1/2" Dr. Sockets: 10,11,12,13,14,15, 16,17,18,19,20,21,22,23,24,27,30,32mm
  - 2pcs 1/2" Dr. Extension Bars: 5" & 10"
  - 1pc 1/2" Dr. Speeder Handle
  - 1pc 1/2" Dr. Universal Joint
  - 1pc 1/2" Dr. Flipper Ratchet Handle W/q,r
  - 1pc 1/2" Dr. Sliding T Handle 10" (ht)
  - 1pc Metal Case

ITEM NO.	SIZE		
HTSW1230	24pcs	5	5



### 24PCS 1/2"DR. SOCKET WRENCH SET

- Contents:
- 18pcs 1/2" Dr. Sockets: 10,11,12,13,14,15,16,17,18,19,20,21,22,23, 24,27,30,32mm
  - 2pcs 1/2" Dr. Extension Bars: 5" & 10"
  - 1pc 1/2" Dr. Universal Joint
  - 1pc 1/2" Dr. Sliding T Bar 10"
  - 1pc 1/2" Dr. Flex Handle 15"
  - 1pc 1/2" Dr. Flipper Ratchet Handle W/q,r
  - Packed: Metal Box

ITEM NO.	SIZE		
HTSW1231	24pcs	5	5



### 24PCS 1/2"DR. SOCKET WRENCH SET

- Contents:
- 18pcs 1/2" Dr. Sockets: 10,11,12,13,14,15,16,17,18,19,20,21,22,23, 24,27,30,32mm
  - 2pcs 1/2" Dr. Extension Bars: 5" & 10"
  - 1pc 1/2" Dr. Universal Joint
  - 1pc 1/2" Dr. Sliding T Bar 10"
  - 1pc 1/2" Dr. Flex Handle 15"
  - 1pc 1/2" Dr. Flipper Ratchet Handle W/q,r
  - Packed: BMC

ITEM NO.	SIZE		
HTSW1232	24pcs	10	10



### 14PCS E TYPE SOCKET WRENCH SET

- Contents:
- Cr-V
  - Size: E4, E5, E6, E7, E8 1/4" Dr. E10, E11, E12, E14, E16 3/8" Dr. E18, E20, E22, E24 1/2" Dr.
  - Packing: BMC

ITEM NO.	SIZE		
HTSW1233	14pcs	10	40



### 13PCS 1/2"DR. SOCKET BITS SET

- Contents:
- Material: Cr-V
  - Satin finish
  - 6pcs 1/2" Dr. socket: 8,9,10,12,14,16mm
  - 7pcs 1/2" Dr. bit Socket: M6,M8,M9,M10,M12,M14,M16
  - Packing: metal Box

ITEM NO.	SIZE		
HTSW1234	13pcs	5	20



### 16PCS 1/2"DR. SOCKET BITS SET

- Contents:
- Material: Cr-V
  - Satin finish
  - 9pcs 1/2" Dr. E Type socket: E10,E11,E12,E14,E16,E18,E20,E22,E24
  - 7pcs 1/2" Dr. bit Socket: T30,T40,T45,T50,T55,T60,T70
  - Packing: metal box

ITEM NO.	SIZE		
HTSW1235	16pcs	5	20



### 12PCS 1/2"DR. SOCKET BITS SET

- Contents:
- 12-1/2" Dr. Bit sockets: T20,T25,T27,T30,T35,T40,T45,T50,T55,T60,T70,T80mm
  - Packed: metal box

ITEM NO.	SIZE		
HTSW1236	12pcs	5	20



### 18PCS HEX SOCKET BITS SET

- Contents:
- 18pcs 1/4" Dr. 1/2"
  - 6pcs Dr. Bit sockets 55L (H)6,7,8,10,12,14 -1/2"Dr.
  - 6pcs Dr. Bit sockets 100L (H)5,6,7,8,10,12 -1/2"Dr.
  - 6pcs Dr. Bit sockets (H)3,4,5,6,7,8 -1/4"Dr.
  - Packed: metal box

ITEM NO.	SIZE		
HTSW1237	18pcs	5	10



### 18PCS TORX SOCKET BITS SET

- Contents:
- 18pcs 1/4" Dr. 1/2"
  - 6pcs Dr. Bit sockets 55L (T)30,40,45,50,55,60 -1/2"Dr.
  - 6pcs Dr. Bit sockets 100L (T)30,40,45,50,55,60 -1/2"Dr.
  - 6pcs Dr. Bit sockets (TH)8,10,15,20,25,27 -1/4"Dr.
  - Packed: metal box

ITEM NO.	SIZE		
HTSW1238	18pcs	5	10



### 7PCS 3/8"DR. HEX SOCKET BITS

- Material: Cr-V
- Construction: 7pcs x 110mm:H 3,4,5,6,7,8,10mm
- Packed: BMC

ITEM NO.	SIZE	📦	🔧
HTSW1239	7pcs		20



### 32PCS 3/8"DR. SOCKET BITS SET

- Material:Cr-V
- Contents:  
10pcs x 55L : T20-T25-T27-T30-T40-T45-T50-T55-T60-T70  
10pcs x 100L : T20-T25-T27-T30-T40-T45-T50-T55-T60-T70  
6pcs x 140L : T40-T45-T50-T55-T60-T70  
6pcs x 200L : T40-T45-T50-T55-T60-T70
- Packed: BMC

ITEM NO.	SIZE	📦	🔧
HTSW1240	32pcs		10



### 26PCS 3/8"DR. SOCKET BITS SET

- Material:Cr-V
- Contents:  
8pcs x 55L : M5-M6-M8-M9-M10-M12-M14-M16  
7pcs x 100L : M5-M6-M8-M9-M10-M12-M14  
7pcs x 140L : M5-M6-M8-M9-M10-M12-M14  
4pcs x 200L : M8-M10-M12-M14
- Packed by BMC

ITEM NO.	SIZE	📦	🔧
HTSW1241	26pcs		10

Industrial



### IMPACT SOCKET WRENCH



- Material: CrMo
- Size: 1/2"Dr.
- Black finish
- 8mm 9mm 10mm 11mm 12mm 13mm 14mm 15mm 16mm 17mm 18mm 19mm 20mm 21mm 22mm 23mm 24mm 25mm 26mm 27mm 28mm 29mm 30mm 32mm

ITEM NO.	SIZE	📦	🔧
HTSW1401	8mm	10	100
HTSW1402	9mm	10	100
HTSW1403	10mm	10	100
HTSW1404	11mm	10	100
HTSW1405	12mm	10	100
HTSW1406	13mm	10	100
HTSW1407	14mm	10	100
HTSW1408	15mm	10	100
HTSW1409	16mm	10	100
HTSW1410	17mm	10	100
HTSW1411	18mm	10	100
HTSW1412	19mm	10	100
HTSW1413	20mm	10	50
HTSW1414	21mm	10	50
HTSW1415	22mm	10	50
HTSW1416	23mm	10	50
HTSW1417	24mm	10	50
HTSW1418	25mm	10	50
HTSW1419	26mm	10	50
HTSW1420	27mm	10	50
HTSW1421	28mm	10	50
HTSW1422	29mm	10	50
HTSW1423	30mm	10	50
HTSW1424	31mm	10	50
HTSW1425	32mm	10	50

Industrial



### IMPACT SOCKET WRENCH



- Material: CrMo
- Size: 3/4"Dr.
- Black finish
- 17mm 18mm 19mm 20mm 21mm 22mm 23mm 24mm 25mm 26mm 27mm 28mm 29mm 30mm 31mm 32mm 33mm 34mm 35mm 36mm 38mm 40mm 41mm 46mm 50mm

ITEM NO.	SIZE	📦	🔧
HTSW1501	17mm	6	72
HTSW1502	18mm	6	72
HTSW1503	19mm	6	72
HTSW1504	20mm	6	72
HTSW1505	21mm	6	72
HTSW1506	22mm	6	72
HTSW1507	23mm	6	72
HTSW1508	24mm	6	72
HTSW1509	25mm	6	36
HTSW1510	26mm	6	36
HTSW1511	27mm	6	36
HTSW1512	28mm	6	36
HTSW1513	29mm	6	36
HTSW1514	30mm	6	36
HTSW1515	31mm	6	36
HTSW1516	32mm	6	36
HTSW1517	33mm	6	36
HTSW1518	34mm	6	36
HTSW1519	35mm	6	36
HTSW1520	36mm	6	36
HTSW1521	37mm	6	36
HTSW1522	38mm	6	36
HTSW1523	39mm	6	24
HTSW1524	40mm	6	24
HTSW1525	41mm	6	24
HTSW1526	42mm	6	24
HTSW1527	43mm	6	24
HTSW1528	44mm	6	24
HTSW1529	45mm	6	24
HTSW1530	46mm	6	24
HTSW1531	47mm	12	
HTSW1532	48mm	12	
HTSW1533	49mm	12	
HTSW1534	50mm	12	

Industrial



### IMPACT SOCKET WRENCH



- Material: CrMo
- Size: 1"Dr.
- Black finish
- 17mm 19mm 21mm 22mm 24mm 27mm 30mm 31mm 32mm 33mm 34mm 35mm 36mm 38mm 41mm 46mm 50mm

ITEM NO.	SIZE	📦	🔧
HTSW1601	17mm	6	36
HTSW1602	18mm	6	36
HTSW1603	19mm	6	36
HTSW1604	20mm	6	36
HTSW1605	21mm	6	36
HTSW1606	22mm	6	36
HTSW1607	23mm	6	36
HTSW1608	24mm	6	36
HTSW1609	25mm	6	36
HTSW1610	26mm	6	36
HTSW1611	27mm	6	36
HTSW1612	28mm	6	36
HTSW1613	29mm	6	24
HTSW1614	30mm	6	24
HTSW1615	31mm	6	24
HTSW1616	32mm	6	24
HTSW1617	33mm	6	24
HTSW1618	34mm	6	24
HTSW1619	35mm	6	24
HTSW1620	36mm	6	24
HTSW1621	37mm	6	24
HTSW1622	38mm	6	24
HTSW1623	39mm	6	12
HTSW1624	40mm	6	12
HTSW1625	41mm	6	12
HTSW1626	42mm	6	12
HTSW1627	43mm	6	12
HTSW1628	44mm	6	12
HTSW1629	45mm	6	12
HTSW1630	46mm	6	12
HTSW1631	47mm	6	
HTSW1632	48mm	6	
HTSW1633	49mm	6	
HTSW1634	50mm	6	

HAND TOOLS

POWER TOOL ACCESSORIES

CAR TOOLS

POWER TOOLS

AIR TOOLS

GARDEN TOOLS

# Hand Tools - Socket Wrench



## 3PCS HEAVY DUTY IMPACT SOCKET WRENCH SET

- Material: Cr-Mo Steel
- Size: 17mm, 19mm, 21mm
- Drive Size: 1/2"
- Socket: 6pt Socket
- Color: Blue, Yellow, Red
- Packing: BMC

ITEM NO.	SIZE		
HTSW1242	3pcs		20



## 8PCS IMPACT SOCKET ADAPTOR SET

Comprehensive set of impact adaptors for use on all types of impact tools. Manufactured from drop-forged Cr-Mo with phosphate finish for added corrosion protection.

- size: 1/4"Dr. (F)-3/8"Dr. (M)
- 1/2"Dr. (F)-3/8"Dr. (M)
- 1/2"Dr. (F)-3/4"Dr. (M)
- 3/4"Dr. (F)-1"Dr. (M)
- 3/8"Dr. (F)-1/4"Dr. (M)
- 3/8"Dr. (F)-1/2"Dr. (M)
- 3/4"Dr. (F)-1/2"Dr. (M)
- 1"Dr. (F)-3/4"Dr. (M)

- Packing: Blow Case

ITEM NO.	SIZE		
HTSW1243	8pcs		20



## 9PCS IMPACT SOCKET BIT SET

- Material: Cr-Mo
- Black Powder Coated
- 8pcs 1/2"dr. socket bit: T20,T25,T30,T40,T45,T50,T55,T60,T70
- Packing: Blow case

ITEM NO.	SIZE		
HTSW1244	9pcs		10



## 10PCS IMPACT SOCKET WRENCH SET

- Material: Cr-Mo
- 1/2"dr.deep socket:8,10,11,12,13,14,15,17,19,21mm
- Black Powder Coated
- Packing: Sliding card

ITEM NO.	SIZE		
HTSW1245	10pcs		16



## 10PCS DEEP IMPACT SOCKET WRENCH SET

- Material: Cr-Mo
- 1/2"dr.deep socket:8,10,11,12,13,14,15,17,19,21mm
- Black Powder Coated
- Packing: Sliding card

ITEM NO.	SIZE		
HTSW1248	10pcs		8



## 10PCS IMPACT SOCKET WRENCH SET

- Material: Cr-Mo
- 1/2"dr.deep socket:9,10,11,13,14,17,19,21,22,24,27mm
- Black Powder Coated
- Packing: Metal Box

ITEM NO.	SIZE		
HTSW1249	10pcs		16



## 7PCS IMPACT SOCKET WRENCH SET

- Material: Cr-Mo
- Black Powder Coated
- 7pcs 1/2"dr. socket: 9,10,11,13,14,17,19mm
- Packing: Metal Box

ITEM NO.	SIZE		
HTSW1246	7pcs		20



## 10PCS DEEP IMPACT SOCKET WRENCH SET

- Material: Cr-Mo
- Black Powder Coated
- 1/2"dr.deep socket:10,12,13,14,15,17,19,21,22,24mm
- Packing: Metal Box

ITEM NO.	SIZE		
HTSW1250	10pcs		16



## 12PCS IMPACT SOCKET BIT SET

- Material: Cr-Mo
- 7pcs 1/2"dr.\*78mm Socket Bit: T30,T40,T45,T50,T55,T60,T70
- 5pcs 3/8"dr.\*38mm Socket Bit: H8,H12,H14,S8,S13
- Packing: Metal Box

ITEM NO.	SIZE		
HTSW1247	12pcs		10



## 13PCS 1/2"DR.DEEP IMPACT SOCKET WRENCH SET

- Material: Cr-Mo
- Black Powder Coated
- 13pcs 1/2"dr. socket:11,12,13,14,16,17,19,21,22,24,27,30,32mm
- Packing: Metal Box

ITEM NO.	SIZE		
HTSW1251	13pcs		10

HAND TOOLS

POWER TOOL ACCESSORIES

CAR TOOLS

POWER TOOLS

AIR TOOLS

GARDEN TOOLS



## MACHINIST HAMMER

- Drop-forged carbon steel hammer head
- Black painted, heat treatment
- Wooden handle
- Packed: color label

ITEM NO.	SIZE		
HTH1001	200g	12	60
HTH1002	300g	6	48
HTH1003	500g	6	36
HTH1004	800g	6	24
HTH1005	1000g	6	24
HTH1006	1500g	6	12
HTH1007	2000g	6	12



## MACHINIST HAMMER

- Drop-forged carbon steel hammer head
- Black painted, heat treatment
- Fiberglass handle with TPR soft grip
- Packed: color label

ITEM NO.	SIZE		
HTH1008	200g	12	60
HTH1009	300g	6	48
HTH1010	500g	6	36
HTH1011	800g	6	24
HTH1012	1000g	6	24
HTH1013	1500g	6	12
HTH1014	2000g	6	12



## CLAW HAMMER

- Drop-forged carbon steel hammer head
- Heat treatment, ground polished
- Wooden handle
- Packed: color label

ITEM NO.	SIZE		
HTH1015	8oz	6	48
HTH1016	12oz	6	48
HTH1017	16oz	6	36



## STONING HAMMER

- Drop-forged carbon steel hammer head
- Black painted, heat treatment
- Wooden handle
- Packed: color label

ITEM NO.	SIZE		
HTH1018	1000g	6	24
HTH1019	1500g	6	12
HTH1020	2000g	6	12



## STONING HAMMER

- Drop-forged carbon steel hammer head
- Black painted, heat treatment
- Fiberglass handle with TPR soft grip
- Packed: color label

ITEM NO.	SIZE		
HTH1021	1000g	6	24
HTH1022	1500g	6	12
HTH1023	2000g	6	12



## CLAW HAMMER

- Drop-forged carbon steel hammer head
- Heat treatment, ground polished
- Fiberglass handle with TPR soft grip
- Packed: color label

ITEM NO.	SIZE		
HTH1024	8oz	6	48
HTH1025	12oz	6	48
HTH1026	16oz	6	36



## BALL PEEN HAMMER

- Drop-forged carbon steel hammer head
- Heat treatment, Ground polished
- Wooden handle
- Packed: color label

ITEM NO.	SIZE		
HTH1027	8oz	6	60
HTH1028	12oz	6	36
HTH1029	16oz	6	36
HTH1030	24oz	6	36
HTH1031	32oz	6	24



## BALL PEEN HAMMER

- Drop-forged carbon steel hammer head
- Heat treatment, Ground polished
- Fiberglass handle with TPR soft grip
- Packed: color label

ITEM NO.	SIZE		
HTH1032	8oz	6	60
HTH1033	12oz	6	48
HTH1034	16oz	6	24
HTH1035	24oz	6	36
HTH1036	32oz	6	24



## ONE-PIECE CLAW HAMMER

- Drop-forged carbon steel hammer head
- Ground polished, heat treatment
- Steel handle
- Packed: color label

ITEM NO.	SIZE		
HTH1037	450g/16oz	4	24



## SLEDGE HAMMER

- Drop-forged carbon steel hammer head
- Heat treatment, black painted
- Fiberglass handle with TPR soft grip
- Packed: color label

ITEM NO.	SIZE		
HTH1038	2LB		24
HTH1039	3LB		16
HTH1040	4LB		12



## ROOFING HAMMER

- Drop-forged carbon steel hammer head
- Ground polished, black painted
- Steel handle
- Packed: color label

ITEM NO.	SIZE		
HTH1041	600g		36



## BRITISH TYPE CLAW HAMMER

- Drop-forged carbon steel hammer head
- Heat treatment, ground polished
- Wooden handle
- Packed: color label

ITEM NO.	SIZE		
HTH1042	21mm		48
HTH1043	23mm		48
HTH1044	25mm		36

HAND TOOLS

POWER TOOL ACCESSORIES

CAR TOOLS

POWER TOOLS

AIR TOOLS

GARDEN TOOLS



# Hand Tools - Hammer



## LONG HANDLE SLEDGE HAMMER

- Drop-forged carbon steel hammer head
- Heat treatment, black painted
- Fiberglass handle with TPR soft grip
- Handle size: 900mm
- Packed: color label

ITEM NO.	SIZE	📦	🔧
HTH1045	10LB	4	
HTH1046	12LB	4	



## LONG HANDLE STONING HAMMER

- Drop-forged carbon steel hammer head
- Heat treatment, black painted
- Fiberglass handle with TPR soft grip
- Handle size: 900mm
- Packed: color label

ITEM NO.	SIZE	📦	🔧
HTH1047	4000g	6	
HTH1048	5000g	4	



## AXE

- Drop-forged head
- Heat treatment, black painted
- Wooden handle
- Packed: color label

ITEM NO.	SIZE	📦	🔧
HTH1049	600g	6	24
HTH1050	1000g	6	24



## AXE

- Drop-forged head
- Fiberglass handle with TPR soft grip
- Packed: color label

ITEM NO.	SIZE	📦	🔧
HTH1051	600g	6	24
HTH1052	1000g	6	24



## TWO WAY Mallet

- Rubber head
- Fiberglass handle with TPR soft grip
- Packed: color label

ITEM NO.	SIZE	📦	🔧
HTH1053	30mm	6	36
HTH1054	35mm	6	24



## HATCHET

- Drop-forged carbon steel
- Heat treatment, black painted
- Fiberglass handle with TPR soft grip
- Packed: color label

ITEM NO.	SIZE	📦	🔧
HTH1055	600g	6	24
HTH1056	2000g	2	6



### 7PCS CARBODY REPAIRING KITS

- Drop-forged head
- Fiberglass handle
- Packed: BMC

ITEM NO.	SIZE	📦	🔧
HTH1057	7pcs	4	



## BLACK RUBBER Mallet

- Rubber hammer head
- Fiberglass handle with TPR soft grip
- Packed: color label

ITEM NO.	SIZE	📦	🔧
HTH1058	450g/16oz	4	24
HTH1059	675g/24oz	4	24



## WHITE RUBBER Mallet

- Rubber hammer head
- Steel handle
- Packed: color label

ITEM NO.	SIZE	📦	🔧
HTH1060	450g/16oz	4	24
HTH1061	675g/24oz	4	24



## DEAD BLOW Mallet

- NON-rebounding, non-spark
- Packed: color label

ITEM NO.	SIZE	📦	🔧
HTH1062	1.5LB	4	24
HTH1063	2LB	4	24
HTH1064	2.5LB	4	24

HAND TOOLS

POWER TOOL ACCESSORIES

CAR TOOLS

POWER TOOLS

AIR TOOLS

GARDEN TOOLS



**SCREWDRIVER**

- Cr-V blade satin finished
- Bi-color comfortable handle grip
- Treated heated
- Black finish magnetic tip
- Packed: plastic hanger in color box



ITEM NO.	SIZE	📦	🔧
HTSD1001	6.0x38mm	12	240
HTSD1002	3.0x75mm	12	192
HTSD1003	5.0x100mm	12	180
HTSD1004	6.0x100mm	12	180
HTSD1005	6.0x150mm	12	180
HTSD1006	8.0x150mm	12	120
HTSD1007	8.0x200mm	12	120
HTSD1008	8.0x250mm	12	120
HTSD1009	8.0x300mm	12	120
HTSD1010	PH2x38mm	12	192
HTSD1011	PH0x75mm	12	180
HTSD1012	PH1x100mm	12	180
HTSD1013	PH2x100mm	12	180
HTSD1014	PH2x150mm	12	180
HTSD1015	PH3x150mm	12	120
HTSD1016	PH3x200mm	12	120
HTSD1017	PH3x250mm	12	120
HTSD1018	PH3x300mm	12	120
HTSD1019	PZ1x100mm	12	180
HTSD1020	PZ1x150mm	12	180
HTSD1021	PZ2x100mm	12	180
HTSD1022	PZ2x150mm	12	180

**GO-THROUGH SCREWDRIVER**

- Cr-V blade satin finished
- Bi-color comfortable handle grip
- Black finish magnetic tip
- Packed: plastic hanger in color box



ITEM NO.	SIZE	📦	🔧
HTSD1023	3.0x75mm		240
HTSD1024	5.0x100mm		240
HTSD1025	6.0x100mm		180
HTSD1026	6.0x150mm		180
HTSD1027	8.0x150mm		120
HTSD1028	PH0x75mm		240
HTSD1029	PH1x100mm		240
HTSD1030	PH2x100mm		180
HTSD1031	PH2x150mm		180
HTSD1032	PH3x200mm		120
HTSD1033	PZ0x75mm		240
HTSD1034	PZ1x100mm		240
HTSD1035	PZ2x150mm		180
HTSD1036	PZ3x200mm		120

**SCREWDRIVER**

- Cr-V blade satin finished
- Transparent PVC handle
- Magnetic tip
- Packed: plastic hanger in color box



ITEM NO.	SIZE	📦	🔧
HTSD1037	3.0x75mm		240
HTSD1038	5.0x100mm		240
HTSD1039	6.0x100mm		180
HTSD1040	6.0x150mm		180
HTSD1041	8.0x150mm		120
HTSD1042	PH0x75mm		240
HTSD1043	PH1x100mm		240
HTSD1044	PH2x100mm		180
HTSD1045	PH2x150mm		180
HTSD1046	PH3x250mm		120
HTSD1047	PZ0x75mm		240
HTSD1048	PZ1x100mm		240
HTSD1049	PZ2x150mm		180
HTSD1050	PZ3x150mm		120

HAND TOOLS

POWER TOOL ACCESSORIES

CAR TOOLS

POWER TOOLS

AIR TOOLS

GARDEN TOOLS



**2PCS SCREWDRIVER SET**

- Cr-V satin finished Treated Heated
- Bi-color comfortable handle
- Size: SL6x100mm, PH2x100mm
- Black finish magnetic tip
- Packed: double blister

ITEM NO.	SIZE	📦	🔧
HTSD1051	2pcs		24



**2PCS GO-THROUGH SCREWDRIVER SET**

- Cr-V satin finished Treated Heated
- Bi-color comfortable handle
- Size: SL6x100mm, PH2x100mm
- Black finish magnetic tip
- Packed: double blister

ITEM NO.	SIZE	📦	🔧
HTSD1052	2pcs		24



**14PCS RATCHET SCREWDRIVER SET**

- 1pc Ratchet Screwdriver
- 1pc Bits Driver (60mm)
- 12pcs Cr-V Bits (6.35\*25mm):5mm, 6mm, 7mm, PH1, PH2, PH3, T10, T15, T20, H4, H5, H6
- Adjustable handle allows ratchet to swing max 60° on the left
- Packed: display box

ITEM NO.	SIZE	📦	🔧
HTSD1053	14pcs	12	48



**16 IN 1 RATCHET SCREWDRIVER SET**

- 1pc Ratchet Screwdriver
- Double blister packing
- 8pcs double end bits 6.35x32mm SL3.0-PH0, SL5-PH1, SL6-PH2, H2.5-H3.0, H4.0-H4.5, T15-T20, T25-T30, S1-S2
- Packing: display box



ITEM NO.	SIZE	📦	🔧
HTSD1054	16 in 1	12	48



### 6PCS SCREWDRIVER SET

- Cr-V blade satin finished Treated Heated
- Bi-color comfortable handle
- SL3x75mm, SL5x100mm, SL6x150mm, PH0x75mm, PH1x100mm, PH2x150mm
- Packed: double blister

ITEM NO.	SIZE		
HTSD1055	6pcs	8	40



### 6PCS SCREWDRIVER SET

- Cr-V blade satin finished
- Transparent PVC handle
- Magnetic tip
- SL3x75mm, SL5x100mm, SL6x150mm, PH0x75mm, PH1x100mm, PH2x150mm
- Packed: double blister

ITEM NO.	SIZE		
HTSD1056	6pcs	8	40



### 8PCS EXTRA TORQUE SCREWDRIVER SET

- Cr-V blade satin finished, treated heated
- PVC handle
- SL5\*75mm, SL6\*100mm, SL8\*150mm, SL9\*200mm, PZ1\*75mm, PZ2\*100mm, PZ3\*150mm, PZ4\*200mm
- Black Finish Magnetic Tape
- Packed: double blister

ITEM NO.	SIZE		
HTSD1057	8pcs	8	10



### 12PCS EXTRA TORQUE SCREWDRIVER SET

- Cr-V blade satin finished, treated heated
- PVC handle
- Size: SL6x38mm, SL3x75mm, SL5x75mm, SL6x100mm, SL8x150mm, 9x200mm, PH2x38mm, PH075mm, PH1x75mm, PH2x100mm, PH3x150mm, PH4x200
- Packed: BMC with window

ITEM NO.	SIZE		
HTSD1058	12pcs	8	10



### 44PCS SCREWDRIVER SET

- Cr-V blade satin finished, treated heated
- Bi-color comfortable grip
- 4pcs slotted: 8x150mm, 6x125mm, 5x100mm, 3x75mm
- 3pcs philips: PH2x125mm, PH1x100mm, PH1x100mm, PH0x75mm
- 1pc bits driver
- 2pcs precision screwdriver: 2.5x50mm, 3.0x50mm
- 2pcs precision screwdriver philips: PH0x50mm, PH0x50mm

ITEM NO.	SIZE		
HTSD1059	44pcs	8	10



- 6pcs precision torx: T5, T6, T7, T8, T9, T10x50mm
- 1pc 1/4" 25mm AD
- 16pcs bits (6.35x25mm): 3mm, 4mm, 5mm, 6mm, PH0, PH1, PH2, PH3, PZ0, PZ1, PZ2, PZ3, H3, H4, H5, H6
- 9pcs 1/4" socket: 4mm, 5mm, 6mm, 7mm, 8mm, 9mm, 10mm, 11mm, 12mm
- Packed: double blister

ITEM NO.	SIZE		
HTSD1060	25pcs	8	10



### 8-IN-1 SCREWDRIVER SET

- Cr-V blade satin finished, treated heated
- Bi-color comfortable grip
- 3pcs slotted: 6.0x60mm, 5.0x60mm(cabinet), 3.0x60mm(cabinet)
- 3pcs philips: PH2x60mm, PH1x60mm, PH0x60mm
- 1pc tack puller: 5x60mm
- 1pc scratch AWL: 3x60mm
- Packed: plastic bracket & color box

ITEM NO.	SIZE		
HTSD1060	8 in 1	6	48



### 37PCS SCREWDRIVER SET

- Material: Cr-V
- PP TPR Handle
- 8pcs Screwdriver: SL8x150mm, SL6x100mm, SL5x75mm, SL6x38mm; PH3x150, PH2x100mm, PH1x75mm, PH2x38mm
- 1pc 1/4" Bit Holder
- 8pcs Precision Screwdriver: SL2.5x50mm, SL3.0x50mm; PH0x50, PH0x50mm, T5-T6-T7-T8
- 20pcs 6.3\*25mm Bits: SL4-5-6, PH1-2-3, PZ0-1-2-3, T10-15-20-25-30-40; H3-4-5-6
- Packing: double blister

ITEM NO.	SIZE		
HTSD1061	37pcs	6	24

Industrial



VDE SCREWDRIVER

- Cr-V blade black finished
- Bi-color comfortable handle grip
- 1000V, VDE certification
- Packed: PP hanger

ITEM NO.	SIZE	📦	🔩
HTSD1101	2.5x75mm	12	240
HTSD1102	3x100mm	12	240
HTSD1103	3.5x100mm	12	120
HTSD1104	4x100mm	12	120
HTSD1105	6.5x150mm	6	72
HTSD1106	PH0x75mm	12	240
HTSD1107	PH1x80mm	12	120
HTSD1108	PH2x80mm	12	120
HTSD1109	PH3x100mm	6	72
HTSD1110	PZ0x60mm	12	240
HTSD1111	PZ1x80mm	12	120
HTSD1112	PZ2x150mm	12	120
HTSD1113	PZ3x150mm	6	72



Screwdriver

6PCS INSULATED SCREWDRIVER

- Cr-V blade
- 5pcs insulated screwdriver
- Size: SL4x100mm,SL6x125mm,SL3x75mm, PH1x100mm,PH2x125mm
- 1pc voltage tester
- Bi-color comfortable grip handle
- Plastic box packing

ITEM NO.	SIZE	📦	🔩
HTSD1118	6pcs		24



Industrial



6PCS VDE SCREWDRIVER SET

- Cr-V blade black finished
- Bi-color comfortable handle grip
- Size: 3x75,4x100,5.5x100,PH1x80,PH2x100,3x140mm
- 1000V, VDE certification
- Packed: double blister

ITEM NO.	SIZE	📦	🔩
HTSD1114	6pcs	6	24



20PCS T-BAR SCREWDRIVER SET

- 1pc T handle bits driver
- 1pc AD (1/4"x25mm)
- 9pcs bits (6.35x25mm), SL3mm,SL4mm,SL5mm,SL6mm,SL8mm,PH0, PH1, PH2, PH3
- 9pcs 1/4" socket: 5mm,6mm,7mm,8mm,9mm,10mm,11mm,12mm,13mm
- Packing: slide card

ITEM NO.	SIZE	📦	🔩
HTSD1116	20pcs		6/36



6 IN 1 RATCHET SCREWDRIVER SET

- 1pc bits holder
- 1pc double ended bits (6.35x65mm): PH1-5mm
- 1pc double ended bits (8x75mm): PH2-6mm
- 1pc nut driver: 6mm-8mm
- Packing: double blister

ITEM NO.	SIZE	📦	🔩
HTSD1119	6 in 1		10/100



7PCS NUT DRIVER SET

- Cr-V
- Bi-color comfortable handle grip
- Size: 5x80mm,6x80mm,8x80mm,9x80mm,10x80mm,11x80mm,12x80mm
- Packing: plastic hanger

ITEM NO.	SIZE	📦	🔩
HTSD1115	7pcs	6	24



34PCS RATCHET SCREWDRIVER SET

- 1pc ratchet screwdriver
- 15pcs bits (6.35x30mm) 4mm,5mm,6mm,PH0, PH1, PH2, PH3, PZ0,PZ1,PZ2,T15,T20,T25,S1,S2
- 1pc 1/4"x30mm AD
- 6pcs 1/4" metric socket: 5mm,6mm,7mm,8mm,9mm,10mm
- 6pcs 1/4" sae socket: 1/4",5/16",11/32",3/8",7/16",1/2"
- 3pcs bits holder
- 2pcs sockets holder
- Packing: double blister

ITEM NO.	SIZE	📦	🔩
HTSD1117	34pcs		6/36



61PCS QUICK-HOLDER SCREWDRIVER BITS SET

- 1pc T-bar Ratchet Screwdriver
- 1pc precision Screwdriver
- 1pc elastic Extension bar
- 9pc 1/4" dr.socket:4-12mm
- 18pcs 6.35x25mm Cr-V Bits: SL3-4-5-6, S2-S3,PH0-1-2-3,PZ1-2-3, T10-15-20-25 adaptor
- 30pcs 4x28mm Cr-V Bits: SL1.5x2,SL2x2,SL2.5x2,SL3x2,PH0,PH00x2,PH000x2, T6-7-8-9-10,T15x2,T20X2,H1.5x2, H2x2,H2.5x2,H3x2
- Plastic box packing

ITEM NO.	SIZE	📦	🔩
HTSD1120	61 pcs		12

HAND TOOLS

POWER TOOL ACCESSORIES

CAR TOOLS

POWER TOOLS

AIR TOOLS

GARDEN TOOLS



# Hand Tools - Screwdriver/Screwdriver Bits Set



## 7 IN 1 RATCHET SCREWDRIVER SET

- 1pc ratchet LED screwdriver
- 7pcs 6.35x25mm bits  
SL5,SL6,PH1,PH2,PH3,T10,T20
- Packed: double blister

ITEM NO.	SIZE		
HTSD1121	7 in 1	12	72



## 6PCS GO-THROUGH SCREWDRIVER SET WITH END CAP

- Cr-V blade satin finished, treated heated
- Bi-color transparent PVC handle
- 6x100mm,6x125mm,6x150mm,6x200mm,PH2x100mm,PH2x125mm,PH2x150mm
- Packed: PVC bag

ITEM NO.	SIZE		
HTSD1122	6pcs		24



## 23PCS SCREWDRIVER BITS SET

- 1pc offset ratchet driver
- 9pcs 1/4" socket size: 5mm,6mm,7mm,8mm,9mm,10mm,11mm,12mm,13mm
- 11pcs 6.35x25mm bits size: SL4,SL5,SL6,PH1,PH2,PH3,PZ1,PZ2,PZ3,T15,T20
- 1pc 1/4"x25mm AD
- 1pc 1/4"x60mm magnetic bits holder
- Packed: plastic box & color sticker

ITEM NO.	SIZE		
HTSD1123	23pcs	10	40



## 22PCS PRECISION SCREWDRIVER BITS SET

- 1pc precision screwdriver bits holder
- 1pc tweezers
- 20pcs precision screwdriver bits 4x28mm size: SL1.0,SL2.0,SL3.0,SL4.0,PH000,PH00,PH0,PH1,PH2,T3,T5,T7,H1.0,H2.0,H3.0,H4.0,PZ00,PZ0,PZ1,PZ2
- Packed: plastic box & color sticker

ITEM NO.	SIZE		
HTSD1124	22pcs	12	48



## 32PCS PRECISION SCREWDRIVER BITS SET

- Material: 6150 Cr-V
- Chromed
- 1pc handle
- 1pc Extension Bar
- 30pcs 4\*25mm bits: SL1,SL1.5,SL2,SL2.5,SL3,SL3.5,SL4;PH000,PH00,PH0,PH1,PH2,PZ00,PZ0,PZ1,PZ2;T5,T6,T7,T8,T9,T10,T15;H0.7,H1.3,H2,H3,H3.5,H4
- Packed: plastic box

ITEM NO.	SIZE		
HTSD1125	32pcs	10	40



## 32PCS QUICK-HOLDER SCREWDRIVER BITS SET

- 1pc 1/4" quick-holder
- 30pcs 6.35x25mm bits size: SL3,SL4,SL5,SL6,SL7,PH0,PH1,PH2,PH3,PZ0,PZ1,PZ2,PZ3,T10,T15,T20,T25,T27,T30,T40,TH10,TH15,TH20,TH27,TH30,TH10,H3,H4,H5,H6
- 1pc 1/4"x25mm AD
- Packed: plastic box & color sticker

ITEM NO.	SIZE		
HTSD1126	32pcs	12	48



## 6PCS PRECISION SCREWDRIVER SET

- High quality carbon steel blade
- Black finished
- Double color handle, PP+TPR
- Size: SL1.4,SL2.0,SL2.4,SL3.0,PH0,PH1
- Packed: plastic box & blister card

ITEM NO.	SIZE		
HTSD1127	6pcs	6	36

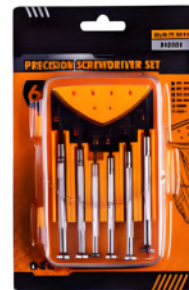

## 6PCS PRECISION SCREWDRIVER SET

- Black finished
- Treated heated
- Size: 1.4,1.8,2.3,3.0,PH0,PH1
- Packed: plastic box & blister card

ITEM NO.	SIZE		
HTSD1128	6pcs	12	72

HAND TOOLS

POWER TOOL ACCESSORIES

CAR TOOLS

POWER TOOLS

AIR TOOLS

GARDEN TOOLS

## Industrial



### 3PCS MAGNETIC POWER NUT

- Material: Cr-V
- 8x65mm, 1/4"
- Packing: Slide card

ITEM NO.	SIZE	10	100
HTSD1129	5pcs		120



### QUICK CHANGE CHUCK

- Material: Stainless steel+Aluminum
- Packing: Slide card

ITEM NO.	SIZE	20	200
HTSD1133	1/4"		



### LONG BIT EXTENSION BAR

- Material: Cr-V
- Surface Sandblasting
- Packed: Slide card

ITEM NO.	SIZE	100	100
HTSD1134	2pcs 60mm		
HTSD1135	2pcs 150mm		



### 10PCS SCREWDRIVER BITS SET

- Material: 6150 Cr-V
- Surface Sandblasting
- 10pcs Bits: 65mm
- Packing: Slide Card

ITEM NO.	SIZE	10	100
HTSD1138	10pcs		



### 10PCS SCREWDRIVER BITS SET

- Material: Cr-V
- Surface Sandblasting
- 10pcs bits: 10mm
- Packing: Slide card

ITEM NO.	SIZE	10	100
HTSD1130	10pcs PH2		
HTSD1131	10pcs SL6		



### 5 IN 1 SCREWDRIVER

- PP+TPR handle
- Cr-V double ended
- Bits: PH0,PH2,SL1/8,SL3/16
- Packed: double blister

ITEM NO.	SIZE	10	100
HTSD1136	5 in 1		



### 10PCS PRECISION SCREWDRIVER SET

- 1pcs Aluminum handle
- 9pcs Cr-V 4\*25mm Bits
- Packed: double blister

ITEM NO.	SIZE	48	
HTSD1139	10pcs		



### 10PCS SCREWDRIVER BIT WITH LIMITER

- Material: Cr-V
- PH2x10pcs
- Packing: Slide card

ITEM NO.	SIZE	10	100
HTSD1132	10pcs		



### 40PCS IMPACT SCREWDRIVER BITS SET

- Material: 6150 Cr-V
- Surface sandblasting
- 2pcs coupler for bits: 3/8" & 1/2"
- 19pcs 10\*30mm Bits: H4-5-6-7-8-10-12; T20-25-30-40-45-50-55; Spline M5-6-8-10-12
- 19pcs 10\*75mm Bits: H4-5-6-7-8-10-12; T20-25-30-40-45-50-55; Spline M5-6-8-10-12
- Packing: metal box

ITEM NO.	SIZE	20	
HTSD1137	40pcs		

## Industrial



### 7PCS IMPACT SCREWDRIVER SET

- 1pc impact screwdriver
- 4pcs 8mmx36mm bits: SL6.5,SL8,PH2,PH3
- 2pcs 8mmx80mm bits: PH3,SL8
- Packing: blow box+color sleeve

ITEM NO.	SIZE	5	20
HTSD1140	7pcs		

# Hand Tools - Hex key



## 9PCS HEX KEY SET

- Cr-V blade satin finished, treated heated
- Size: 1.5mm,2mm,2.5mm,3mm,4mm,5mm,6mm,8mm,10mm
- Packed: double blister

ITEM NO.	SIZE		
HTHK1001	9pcs	10	60



## 9PCS BALL END HEX KEY SET

- Cr-V blade satin finished, treated heated
- Size: 1.5mm,2mm,2.5mm,3mm,4mm,5mm,6mm,8mm,10mm
- Packed: double blister

ITEM NO.	SIZE		
HTHK1002	9pcs	10	60



## 9PCS TORX KEY SET

- Cr-V blade satin finished, treated heated
- Size: T10,T15,T20,T25,T27,T30,T40,T45,T50
- Packed: double blister

ITEM NO.	SIZE		
HTHK1003	9pcs	10	60



## 9PCS LONG HEX KEY SET

- Cr-V blade satin finished, treated heated
- Size: 1.5mm,2mm,2.5mm,3mm,4mm,5mm,6mm,8mm,10mm
- Packed: double blister

ITEM NO.	SIZE		
HTHK1004	9pcs	10	60



## 9PCS LONG BALL END HEX KEY SET

- Cr-V blade satin finished, treated heated
- Size: 1.5mm,2mm,2.5mm,3mm,4mm,5mm,6mm,8mm,10mm
- Packed: double blister

ITEM NO.	SIZE		
HTHK1005	9pcs	10	60



## 9PCS LONG TORX KEY SET

- Cr-V blade satin finished, treated heated
- Size: T10,T15,T20,T25,T27,T30,T40,T45,T50
- Packed: double blister

ITEM NO.	SIZE		
HTHK1006	9pcs	10	60



## 9PCS EXTRA LONG HEX KEY SET

- Cr-V blade satin finished, treated heated
- Size: 1.5mm,2mm,2.5mm,3mm,4mm,5mm,6mm,8mm,10mm
- Packed: double blister

ITEM NO.	SIZE		
HTHK1007	9pcs	10	60



## 9PCS EXTRA LONG BALL END HEX KEY SET

- Cr-V blade satin finished, treated heated
- Size: 1.5mm,2mm,2.5mm,3mm,4mm,5mm,6mm,8mm,10mm
- Packed: double blister

ITEM NO.	SIZE		
HTHK1008	9pcs	10	60



## 9PCS EXTRA LONG TORX KEY SET

- Cr-V blade satin finished, treated heated
- Size: T10,T15,T20,T25,T27,T30,T40,T45,T50
- Packed: double blister

ITEM NO.	SIZE		
HTHK1009	9pcs	10	60

Industrial



Hex Key

## 9PCS LONG BALL END HEX KEY SET

- S2 blade satin finished, treated heated
- Size: 1.5mm,2mm,2.5mm,3mm,4mm,5mm,6mm,8mm,10mm
- Packed: double blister

ITEM NO.	SIZE		
HTHK1010	9pcs	10	60

Industrial



Hex Key

## 9PCS EXTRA LONG BALL END HEX KEY SET

- S2 blade satin finished, treated heated
- Size: 1.5mm,2mm,2.5mm,3mm,4mm,5mm,6mm,8mm,10mm
- Packed: double blister

ITEM NO.	SIZE		
HTHK1011	9pcs	10	60

HAND TOOLS

POWER TOOL ACCESSORIES

CAR TOOLS

POWER TOOLS

AIR TOOLS

GARDEN TOOLS



HEX KEY

- S2 steel mirror polished
- Heat treated chrome coated
- Color box packing

ITEM NO.	SIZE	📦	📦
HTHK1018	1.5mm	300	4800
HTHK1019	2mm	200	3200
HTHK1020	2.5mm	150	2400
HTHK1021	3mm	100	1600
HTHK1022	4mm	80	1280
HTHK1023	5mm	50	800
HTHK1024	6mm	50	600
HTHK1025	8mm	50	300
HTHK1026	10mm	40	240
HTHK1027	T9	300	4800
HTHK1028	T10	200	3200
HTHK1029	T15	150	2400
HTHK1030	T20	100	1600
HTHK1031	T25	80	1280
HTHK1032	T27	50	800
HTHK1033	T30	50	600
HTHK1034	T40	50	300
HTHK1035	T50	40	240



HEX KEY

- S2 steel
- Chrome coated, mirror polished
- Comfortable T-handle grip
- Color box packing

ITEM NO.	SIZE	📦	📦
HTHK1036	1.5mm	10	120
HTHK1037	2mm	10	120
HTHK1038	2.5mm	10	120
HTHK1039	3mm	10	120
HTHK1040	4mm	10	120
HTHK1041	5mm	10	120
HTHK1042	6mm	10	120
HTHK1043	8mm	10	120
HTHK1044	10mm	10	120
HTHK1045	T9	10	120
HTHK1046	T10	10	120
HTHK1047	T15	10	120
HTHK1048	T20	10	120
HTHK1049	T25	10	120
HTHK1050	T27	10	120
HTHK1051	T30	10	120
HTHK1052	T40	10	120
HTHK1053	T50	10	120



9PCS T-HANDLE (BALL END) HEX KEY SET

- Cr-V blade satin finished, treated heated
- Size: 2.0x100mm, 2.5x100mm, 3.0x100mm, 4.0x150mm, 5.0x150mm, 5.5x150mm, 6.0x150mm, 8.0x200mm, 10.0x200mm
- Double blister packing

ITEM NO.	SIZE	📦	📦
HTHK1012	9pcs	5	20



9PCS T-HANDLE TORX KEY SET

- Cr-V blade satin finished, treated heated
- Size: T10x100mm, T15x100mm, T20x100mm, T25x150mm, T27x150mm, T30x150mm, T40x150mm, T45x200mm, T50x200mm
- Double blister packing

ITEM NO.	SIZE	📦	📦
HTHK1013	9pcs	5	20



10PCS HEX KEY

- High quality carbon steel sheet treatment
- Black finished
- Size: 1mm, 1.5mm, 2mm, 2.5mm, 3mm, 4mm, 5mm, 6mm, 8mm, 10mm
- Shink card packing



ITEM NO.	SIZE	📦	📦
HTHK1014	7pcs	10	80



10PCS T-HANDLE TORX KEY SET

- Cr-V blade satin finished, treated heated
- Size: T10x100mm, T15x100mm, T20x100mm, T25x150mm, T27x150mm, T30x150mm, T40x150mm, T45x200mm, T50x200mm
- Bi-color comfortable T-handle grip
- Iron frame
- Color box packing

ITEM NO.	SIZE	📦	📦
HTHK1015	10pcs	10	



8PCS FOLDING HEX KEY SET

- Cr-V blade treated heated satin finished
- Size: 2mm, 2.5mm, 3mm, 4mm, 5mm, 6mm, 8mm
- Bi-color frame
- Plastic card packing

ITEM NO.	SIZE	📦	📦
HTHK1016	8pcs	10	60



8PCS FOLDING TORX KEY SET

- Cr-V blade treated heated satin finished
- Size: T9-T10-T15-T20-T25-T27-T30-T40
- Bi-color frame
- Plastic card packing

ITEM NO.	SIZE	📦	📦
HTHK1017	8pcs	10	60

HAND TOOLS  
POWER TOOL ACCESSORIES  
CAR TOOLS  
POWER TOOLS  
AIR TOOLS  
GARDEN TOOLS



**Industrial**



**PVC PIPE CUTTER**

- Aluminum alloy body
- 65Mn blade
- Packed by sliding card

ITEM NO.	SIZE		
HTPC1000	42mm	6	48



**PVC PIPE CUTTER**

- Aluminum alloy body
- 65Mn blade
- Packed by sliding card

ITEM NO.	SIZE		
HTPC1001	42mm	6	48



**PVC PIPE CUTTER**

- Aluminum alloy body
- 65Mn blade
- Packed by sliding card

ITEM NO.	SIZE		
HTPC1002	32mm	6	60



**PIPE CUTTER**

- Zinc body
- Used for aluminum brass pipe
- Packed by sliding card

ITEM NO.	SIZE		
HTPC1003	3-22mm	20	100



**PIPE CUTTER**

- Aluminum alloy body
- Used for aluminum brass pipe
- Packed by sliding card

ITEM NO.	SIZE		
HTPC1004	3-28mm		50



**PIPE CUTTER**

- Aluminum alloy body
- Used for aluminum brass pipe
- Packed by sliding card

ITEM NO.	SIZE		
HTPC1005	3-32mm		72
HTPC1006	3-32mm		72

**Industrial**



**PIPE CUTTER**

- Double casting iron body
- Used for aluminum brass steel pipe
- Packed by color box

ITEM NO.	SIZE		
HTPC1007	2#		12
HTPC1008	3#		10

**Industrial**



**PIPE VICE**

- Malleable cast in on body
- Packed by color box

ITEM NO.	SIZE		
HTPC1009	0#		10
HTPC1010	1#		4
HTPC1011	2#		4
HTPC1012	3#		2
HTPC1013	4#		2
HTPC1014	5#		1



HAND TOOLS

POWER TOOL ACCESSORIES

CAR TOOLS

POWER TOOLS

AIR TOOLS

GARDEN TOOLS



### FLARING TOOLS FOR EXPANDING TUBE

- Material: carbon steel and zinc alloy
- Packed by double blister

ITEM NO.	SIZE		
HTPC1015	1/8"-3/4"	10	20
HTPC1016	5/16" -5/8"	10	20



### FLARING TOOLS FOR EXPANDING TUBE

- Material: carbon steel and zinc alloy
- Use with copper and aluminum
- Precision-machined steel die bar
- Die sizes: 3/16", 1/4", 5/16" 3/8", 1/2", 5/8"
- Rubbed steel yoke with T-bar handle
- Produces 45 degrees flare angle
- Packed by double blister

ITEM NO.	SIZE		
HTPC1017	3pcs	40	



### STEEL HOSE CLAMP

- Zinc plated
- Packed by double blister

ITEM NO.	SIZE		
HTPC1018	3/8"	60	
HTPC1019	1/2"	60	
HTPC1020	5/8"	60	
HTPC1021	3/4"	60	
HTPC1022	7/8"	60	
HTPC1023	1"	60	



### RATCHET DIE STOCKS

- BSPT
- Chrome-plated finish
- 1 ratcheting pipe threading system with 2 extension bars
- Packed by BMCT

ITEM NO.	SIZE		
HTPC1024	1/2"-1-1/4"	4	
HTPC1025	3/8"-1-1/4"	4	
HTPC1026	1/4"-1-1/4"	4	

### RATCHET DIE STOCKS

- BSPT
- Chrome-plated finish
- 1 ratcheting pipe threading system with 2 extension bars
- Packed by BMCT

ITEM NO.	SIZE		
HTPC1027	1/4"-1-1/4"	4	



### 3 IN 1 PIPE BENDER

- Aluminum alloy body
- Plastic powder coated finish
- Bending pipe up to 180°
- Packed by color box

ITEM NO.	SIZE		
HTPC1028	6mm/8mm/10mm	10	



### 419PCS O RING

- Packed by plastic box

ITEM NO.	SIZE		
HTPC1029	419pcs	36	



### 35PCS PIPE TOOLS

- Contents: tube bender 8, 10, 12, 14, 16mm
- Pipe cutter type 3-28mm
- Tube flaring kits 3/16" - 5/8"
- 31pcs small parts
- Packed-BMC

ITEM NO.	SIZE		
HTPC1030	35pcs	5	

HAND TOOLS

POWER TOOL ACCESSORIES

CAR TOOLS

POWER TOOLS

AIR TOOLS

GARDEN TOOLS

# Hand Tools - Measuring Tools



## MEASURING TAPE

- ABS case, TPR coated
- Combination holding feel and impact resistant
- Manual powerful stop button
- Double blister packing

ITEM NO.	SIZE	12/120	6/60
HTMT1001	3M/10ftx16mm	12/120	



## MEASURING TAPE

- ABS case TPR coated
- Comfortable holding feel and impact resistant
- Manual powerful stop button
- Double blister packing

ITEM NO.	SIZE	12/120	10/100
HTMT1002	5M/16ftx19mm	12/120	
HTMT1003	5M/10ftx25mm		10/100



## MEASURING TAPE

- ABS case, TPR coated
- Combination holding feel and impact resistant
- Manual powerful stop button
- Double blister packing

ITEM NO.	SIZE	6/60
HTMT1004	7.5M/25ftx25mm	6/60



## MEASURING TAPE

- ABS case, TPR coated
- Combination holding feel and impact resistant
- Manual powerful stop button
- Double blister packing

ITEM NO.	SIZE	6/60
HTMT1005	10M/33ftx25mm	6/60



## MEASURING TAPE

- ABS case
- Comfortable holding feel and impact resistant
- Manual powerful stop button
- Double blister packing

ITEM NO.	SIZE	12/120	10/100	6/60
HTMT1006	3M/10ftx16mm	12/120		
HTMT1007	5M/16ftx19mm	12/120		
HTMT1008	5M/16ftx25mm		10/100	
HTMT1009	7.5M/25ftx25mm			6/60
HTMT1010	10M/33ftx25mm			6/60



## STAINLESS STEEL MEASURING TAPE

- ABS case
- Comfortable holding feel and impact resistant
- Manual powerful stop button
- Double blister packing

ITEM NO.	SIZE	12/120	10/100	6/60
HTMT1011	3M/10ftx16mm	12/120		
HTMT1012	5M/16ftx19mm	12/120		
HTMT1013	5M/16ftx25mm		10/100	
HTMT1014	7.5M/25ftx25mm			6/60
HTMT1015	10M/33ftx25mm			6/60



## SELF LOCK MEASURING TAPE

- ABS case TPR coated
- Comfortable holding feel and impact resistant
- Manual powerful stop button
- Double blister packing

ITEM NO.	SIZE	12	120	10	100	6	60
HTMT1016	3m/10ftx13mm	12	120				
HTMT1017	5m/16ftx25mm			10	100		
HTMT1018	6m/25ftx25mm			6	60		



## FIBERGLASS TAPE

- ABS case TPR coated
- With metric inch fiberglass tape
- Color box packing



Fiberglass tape

ITEM NO.	SIZE	40
HTMT1020	20M/66ftx13mm	40
HTMT1021	30M/100ftx13mm	40
HTMT1022	50M/165ftx13mm	40



## 3X FAST RETRACTING LONG STEEL TAPE

- 3X Fas retracting the blade
- Material: ABS+TPR shell high carbon steel long steel tape with: 12.5mm, 3:1 gear ratio
- Packing color box



Steel tape

ITEM NO.	SIZE	20
HTMT1023	20M/66ftx12.5mm	20
HTMT1024	30M/100ftx12.5mm	20
HTMT1025	50M/165ftx12.5mm	20



## SELF LOCKING MEASURING TAPE

- PC case
- Comfortable holding feel
- Packing: color box

ITEM NO.	SIZE	10	100
HTMT1019	5M/16ftx25mm	10	100

HAND TOOLS

POWER TOOL ACCESSORIES

CAR TOOLS

POWER TOOLS

AIR TOOLS

GARDEN TOOLS



**3X FAST RETRACTING FIBERGLASS TAPE**

- ABS case for impact resistant
- 3.1 gear ratio
- With metric inch fiberglass tape
- Color box packing



Fiberglass tape

ITEM NO.	SIZE		
HTMT1026	30M/10ftx13mm		20
HTMT1027	50M/10ftx13mm		20
HTMT1028	100M/10ftx13mm		10



**3X FAST RETRACTING OPEN REEL LONG STEEL PLATE**

- 3x Fast Retracting The Blade
- Material: ABS + TPR Shell, high Steel Long Steel Tape
- Width: 12.5mm, 3.1 Gear Ratio
- Packing color box



Steel tape

ITEM NO.	SIZE		
HTMT1029	20mm		10
HTMT1030	30mm		10
HTMT1031	50mm		10

HAND TOOLS

POWER TOOL ACCESSORIES

CAR TOOLS

POWER TOOLS

AIR TOOLS

GARDEN TOOLS



**5-LINE LASER CROSS LEVEL**

- Wavelength of the laser, Vertical horizontal 5\*635mm
- Automatic angling range:: about 23°
- Launch Angle: 120°
- Level accuracy : ±1mm 5m
- Vertical accuracy : ±1mm 5m
- Power supply: 3x 1.5V battery
- Working temperature: 10°C-45°C
- Packed by BMC

ITEM NO.	SIZE		
HTMT1032			5



**OIL MEASURING TAPE**

- Stainless steel brass thumb tape
- Packed by plastic box

ITEM NO.	SIZE		
HTMT1033	5mm		10
HTMT1034	10mm		10
HTMT1035	15mm		10
HTMT1036	20mm		10
HTMT1037	30mm		10

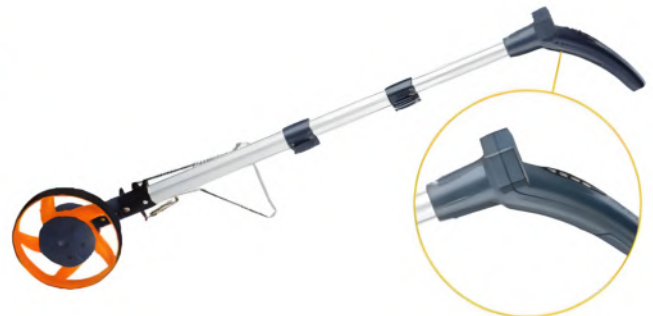

**DIGITAL DISPLAY MEASURING WHEEL**

- Display resolution: 0.1m
- Tolerance: < 0.5%
- Measuring range: 0-9999M
- Power supply: 2XLR3 batteries
- Aluminum alloy extension tube
- Packed by color display

ITEM NO.	SIZE		
HTMT1039	0-9999m		5

**CROSS LINE**

- Wavelength: 630-690mm
- Laser class: class II
- Output power: ≤ 1mw or ≤5mw
- Precision: ±0.5mm/m
- Power: 2x1.V AA battery
- Packed by BMC

ITEM NO.	SIZE		
HTMT1038			1





## TORPEDO LEVEL

- ABS body with aluminum frame
- With 3 vials
- Magnetic strip

ITEM NO.	SIZE	📦	🔧
HTMT1040	225mm, 9"	10	100



## TORPEDO LEVEL

- ABS body with aluminum frame
- With 3 vials
- Magnetic strip

ITEM NO.	SIZE	📦	🔧
HTMT1041	225mm, 9"	10	100



## ALUMINUM LEVEL

- Aluminum magnet with frame
- Color sleeve packed

- 3 high quality vials

ITEM NO.	SIZE	📦	🔧
HTMT1042	30cm, 12"	50	
HTMT1043	40cm, 16"	50	
HTMT1044	50cm, 20"	50	
HTMT1045	60cm, 24"	50	
HTMT1046	80cm, 32"	50	
HTMT1047	100 cm, 40"	30	
HTMT1048	120cm, 48"	30	



## PROFESSIONAL LEVEL

- Aluminum frame , milled on bottom
- High quality vials 0.5mm/1m

- 1.2mm thickness
- Color sleeve packing

ITEM NO.	SIZE	📦	🔧
HTMT1049	40cm, 16"	60	
HTMT1050	50cm, 20"	60	
HTMT1051	60cm, 24"	60	
HTMT1052	80cm, 32"	0	
HTMT1053	100 cm, 40"	30	
HTMT1054	120cm, 48"	30	



## HEAVY-DUTY ALUMINUM LEVEL

- Aluminum frame
- 3 high quality vials

- With 2 handle
- Color sleeve packed

ITEM NO.	SIZE	📦	🔧
HTMT1055	40cm, 16"	30	
HTMT1056	60cm, 24"	30	
HTMT1057	80cm, 32"	30	
HTMT1058	100 cm, 40"	30	
HTMT1059	120cm, 48"	30	



## ALUMINUM LEVEL

- 3 high quality vials
- V-groove working edge fits
- Color packed

ITEM NO.	SIZE	📦	🔧
HTMT1060	30cm, 12"	50	
HTMT1061	60cm, 24"	50	
HTMT1062	80cm, 32"	50	
HTMT1063	100 cm, 40"	30	
HTMT1064	120cm, 48"	30	



## ALUMINUM LEVEL

- Aluminum pressure coating
- 2 vials accuracy 0.5mm/1m
- Color sleeve packing

ITEM NO.	SIZE	📦	🔧
HTMT1065	40cm	60	
HTMT1066	50cm	60	
HTMT1067	60cm	30	





### ALUMINUM SQUARE

- Aluminum blade and handle
- Packed by hanger card

ITEM NO.	SIZE	📦	📦
HTMT1068	250mm, 10"	10	60
HTMT1069	300mm, 12"	10	60
HTMT1070	350mm, 14"	10	60



### BLACK SQUARE

- Black painted
- Packed by color label

ITEM NO.	SIZE	📦	📦
HTMT1071	200x300x2.0mm	72	
HTMT1072	400x600x2.0mm	36	



### STAINLESS STEEL RULER

- Stainless steel
- Packed by PVC bag

ITEM NO.	SIZE	📦	📦
HTMT1073	150mm, 6"	600	
HTMT1074	300mm, 12"	300	
HTMT1075	500mm, 20"	240	



### ACTIVITY SQUARE

- Plastic handle
- Stainless steel body
- Packed by sliding body
- 20mm, 8"

ITEM NO.	SIZE	📦	📦
HTMT1076	200mm/9"	12	144



### PLASTIC FOLDING RULER

- Material ABS
- Slide card
- 2m/10 folding

ITEM NO.	SIZE	📦	📦
HTMT1077	2m	12	144



### COMBINATION RULER

- Stainless steel with aluminum blade
- Color sleeve packed

ITEM NO.	SIZE	📦	📦
HTMT1078	12"/300mm	10	60



### VERNIER CALIPER

- High quality carbon steel
- Accuracy: 0.02mm
- Color box packing

ITEM NO.	SIZE	📦	📦
HTMT1079	150mm	50	
HTMT1080	200mm	50	
HTMT1081	300mm	50	



### DIAL CALIPER

- High quality carbon steel
- Accuracy: 0.02mm
- Color box packing

ITEM NO.	SIZE	📦	📦
HTMT1082	150mm	50	
HTMT1083	200mm	20	
HTMT1084	300mm	20	



### DIGITAL CALIPER

- stainless steel with iron shell
- Accuracy 0.01mm
- Packed by plastic case with color box

ITEM NO.	SIZE	📦	📦
HTMT1085	150mm	50	



### DIGITAL CALIPER

- stainless steel
- Accuracy 0.01mm
- color box packing

ITEM NO.	SIZE	📦	📦
HTMT1086	150mm	50	

HAND TOOLS

POWER TOOL ACCESSORIES

CAR TOOLS

POWER TOOLS

AIR TOOLS

GARDEN TOOLS



### OUTSIDE MICROMETER

- Carbide measuring face
- Chrome finish scale
- Plastic box & color sticker

ITEM NO.	SIZE		
HTMT1087	0-25mm	50	
HTMT1088	25-50mm	50	
HTMT1089	50-75mm	50	
HTMT1090	75-100mm	50	



### OUTSIDE MICROMETER

- Chrome finish scale
- Plastic box & color sticker

ITEM NO.	SIZE		
HTMT1091	0-25mm	50	
HTMT1092	25-50mm	50	
HTMT1093	50-75mm	50	
HTMT1094	75-100mm	50	



### DIGITAL OUTSIDE MICROMETER

- Chrome finish scale
- Plastic box & color sticker

ITEM NO.	SIZE		
HTMT1095	0-25mm	50	
HTMT1096	25-50mm	50	
HTMT1097	50-75mm	50	
HTMT1098	75-100mm	50	



### DIAL INDICATOR

- Accuracy: 0.01mm
- Plastic case & color box

ITEM NO.	SIZE		
HTMT1099	0-5mm(0.01mm)	50	
HTMT1100	0-10mm(0.01mm)	50	
HTMT1101	0-20mm(0.01mm)	50	



### FEELER GAUGES

- 3pcs blade
- Length: 10mm, B type
- Spring steel blades
- Length: 100mm
- Slide card

ITEM NO.	SIZE		
HTMT1102	0.05mm-1.00mm 32pcs	72	



### 4PCS MICROMETER T

- 0-25, 25-50, 50-75, 75-100mm
- Plastic case & color box

ITEM NO.	SIZE		
HTMT1103	4pcs	50	



### DIGITAL DIAL INDICATOR

- Digital Indicator powered by battery of 1.5V which can be used nearly one year
- Big prompt to read conveniently
- Alarm flickeringly when the voltage is low
- Size: 0-12.7mm
- Packing : plastic case & color box

ITEM NO.	SIZE		
HTMT1104	0-12.7mm	72	



### HIGH PRECISION BORE GAGE SET

- Measure the diameter, roundness, taper and the distance of the parallel surface
- Supre wide positioning protector to ensure automatic centering in the hole
- Range: 50-180MM
- Grad: 0.01MM
- Packing: BMC

ITEM NO.	SIZE		
HTMT1105	50-160mm	72	



### ELECTRONIC CLASP SCALE

- Powered by 2x1.5v battery
- Big screen plastic body
- Packed by color box

ITEM NO.	SIZE		
HTMT1106	50-160mm	72	

HAND TOOLS

POWER TOOL ACCESSORIES

CAR TOOLS

POWER TOOLS

AIR TOOLS

GARDEN TOOLS

**Industrial**



**MAGNETIC STANDS WITH ADJUSTMENT**

- Magnetic force 60kgs
- Main size: 12x176mm
- Base size: 63x55x60mm
- Color box

ITEM NO.	SIZE		
HTMT1107	586N/60kgs	60	

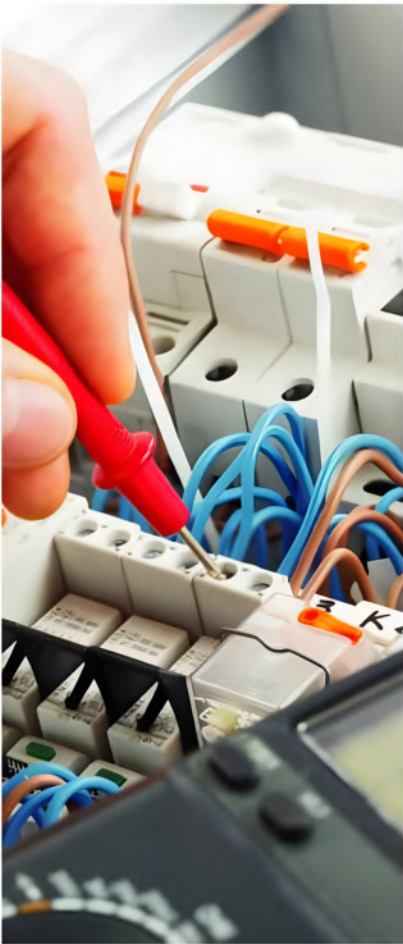

Function	Measuring Range	Accuracy
DCV	1000V	±1.0%
ACV	750V	±1.2%
ACA	200-1000A	±2.0%
OHM	200-20KΩ	±1.0%
	20M-2000MΩ	

**Industrial**



**DIGITAL CLAMP METER**

- 3 1/2 Digits LCD, Max Reading 1999
- 6 Functions, 17 Ranges
- Data-hold Function
- Low battery Indication
- Audible Continuity
- Plug-in Insulation Tester Adapter 500VDC
- Packed by blister card

ITEM NO.	SIZE		
HTMT1108	Em266	40	

Function	Measuring Range	Accuracy
DCV	200m-2000m-20-200-1000V	±0.5%+2d
ACV	200-750V	±1.0%
ACA	200µ-20m-200m-10A	±1.8%
OHM	200-2000-20K-200K-2000KΩ	±1.0%
Diode Check	3V/05mA	



**DIGITAL MULTIMETERS**

- Packed by blister card

ITEM NO.	SIZE		
HTMT1110	DT930B	100	



**DIGITAL INFRARED THERMOMETER**

- Packed by blister card

ITEM NO.	SIZE		
HTMT1115	-36°F/-38°C-520°C/968°F	12	

Function	Measuring Range	Accuracy
DCV	200m-2-20-200-1000V	±0.5%
ACV	200m-2-20-200-750V	±1.0%
DCA	2m-20m-200m-20A	±1.8%
ACA	2m-20m-200m-20A	±1.0%
OHM	200-2K-20K-200K-2M-20M-200MΩ	±1.0%
CAP	20n-200n-2µ-20µ-200µF	±4.0%

**Industrial**



**DIGITAL MULTIMETERS**

- 3 1/2 Digits LCD, Max Reading 1999
- Low battery Indication
- Overload protection
- Audible Continuity
- Packed by blister card

ITEM NO.	SIZE		
HTMT1109	DT9205A	40	

**Industrial**



**LASER DISTANCE METER**

- Plastic box & color sticker

ITEM NO.	SIZE		
HTMT1111	40m	40	
HTMT1112	60m	40	
HTMT1113	80m	40	
HTMT1114	100m	40	



**DIGITAL INFRARED THERMOMETER**

- Packed by blister card

ITEM NO.	SIZE		
HTMT1116	-4°F/-20°C-320°C/608°F	12	

# Hand Tools - Voltage Tester/ Cable Tie



## VOLTAGE TESTER

- Size: 3x140mm
- Rated voltage range: 100 -250V
- GS certified
- Slide card packing

ITEM NO.	SIZE		
HTVT1000	AC 100 - 500V	20	400



## VOLTAGE TESTER

- Size: 4x190mm
- Rated voltage range: 100 -250V
- GS certified
- Slide card packing

ITEM NO.	SIZE		
HTVT1001	AC 100 - 500V	20	200



## DIGITAL VOLTAGE TESTER

- ABS shell
- Size: 3x130mm
- Rated voltage range: 12-35-55 110 -220V
- Slide card packing

ITEM NO.	SIZE		
HTVT1002	12-220V AC DC	25	500



## DIGITAL VOLTAGE TESTER

- ABS shell
- Size: 4x190mm
- Rated voltage range: 12-35-55 110 -220V
- Slide card packing

ITEM NO.	SIZE		
HTVT1003	12-220V AC DC	12	120



## VOLTAGE TESTER

- Size: 3x140mm
- Rated voltage range: 6V-12V-24V
- GS certified
- Slide card packing

ITEM NO.	SIZE		
HTVT1004	DC 6V-24V	20	240



## VOLTAGE TESTER

- Size: 5x190mm
- Rated voltage range: 6V-12V-24V
- GS certified
- Slide card packing

ITEM NO.	SIZE		
HTVT1005	DC 6V-24V	25	100



## 2PCS VOLTAGE TESTER SET

- 1pc 3x140mm
- 1pc 4x190mm
- Rated voltage range: 100-250V
- GS certified
- Slide card packing

ITEM NO.	SIZE		
HTVT1006	2pcs	12	144



## CABLE TIE

- Material: Nylon
- Packed by PVC bay

ITEM NO.	SIZE		
HTCT1000	100x2.50mm	500	
HTCT1001	200x2.50mm	200	
HTCT1002	300x2.50mm	100	
HTCT1003	400x2.50mm	50	
HTCT1004	500x2.50mm	50	



## CABLE TIE

- Material Nylon
- Size: 3x100mm x 400pcs, 4x160mm x 100pcs, 4x200mmx100pcs
- Packed by plastic box

ITEM NO.	SIZE		
HTCT1005	600pcs	36	



## F-CLAMP

- Nickle plated bar, thread bar
- Plastic Handle
- Packed by hang tag

ITEM NO.	SIZE	📦	🔪
HTCL1000	50x150mm	50	
HTCL1001	50x200mm	50	
HTCL1002	50x250mm	50	
HTCL1003	50x300mm	50	
HTCL1004	80x200mm	20	
HTCL1005	80x250mm	20	
HTCL1006	80x300mm	20	
HTCL1007	80x500mm	20	
HTCL1008	120x300mm	10	
HTCL1009	120x500mm	10	
HTCL1010	120x800mm	6	
HTCL1011	120x1000mm	6	



## DIN STANDARD F-CLAMP

- Nickle plated bar, Nickle plated thread bar
- Packed by hang tag
- Wooden handle

ITEM NO.	SIZE	📦	🔪
HTCL1012	50x150mm	50	
HTCL1013	50x200mm	50	
HTCL1014	50x250mm	50	
HTCL1015	50x300mm	50	
HTCL1016	80x200mm	20	
HTCL1017	80x250mm	20	
HTCL1018	80x300mm	20	
HTCL1019	80x500mm	20	
HTCL1020	120x300mm	10	
HTCL1021	120x500mm	10	
HTCL1022	120x800mm	6	
HTCL1023	120x1000mm	6	



## G-CLAMP

- Black powder coated bar
- Zinc plated thread bar
- Packed by color sleeve

ITEM NO.	SIZE	📦	🔪
HTCL1024	75mm, 3"	6	48
HTCL1025	100mm, 4"	6	36
HTCL1026	150mm, 6"	6	18
HTCL1027	200mm, 8"	6	12



## LIGHT G-CLAMP

- Black powder coated bar
- Zinc plated thread bar
- Size: 1" 2" 3"
- Packed by slide card

ITEM NO.	SIZE	📦	🔪
HTCL1028	3pcs		48



## 2-JAW GEAR PULLER

- Drop- forged CR-V steel
- Chrome plated
- Packing color box

ITEM NO.	SIZE	📦	🔪
HTCL1029	3"		20
HTCL1030	4"		20
HTCL1031	5"		10
HTCL1032	6"		12
HTCL1033	8"		5
HTCL1034	10"		4
HTCL1035	12"		2



## SPRING CLAMP

- Nylon-fiberglass mixture body
- Packed by hang tag
- PE jaws

ITEM NO.	SIZE	📦	🔪
HTCL1036	25mm, 1"		1000
HTCL1037	50mm, 2"		1000
HTCL1038	75mm, 3"		400
HTCL1039	100mm, 4"		200
HTCL1040	100mm, 4"		200
HTCL1041	125mm, 5"		100
HTCL1042	150mm, 6"		100
HTCL1043	200mm, 8"		100
HTCL1044	250mm, 10"		100



## QUICK RATCHET BAR CLAMP

- Hard plastic body
- Black finished bar
- Soft non-marking pads
- Packed by hang tag

ITEM NO.	SIZE	📦	🔪
HTCL1045	4"x34mm		120
HTCL1046	6"x34mm		120
HTCL1047	4"x46mm		96
HTCL1048	6"x46mm		96
HTCL1049	6"x63mm		48
HTCL1050	12"x63mm		36



## 3-JAW GEAR PULLER

- Drop- forged CR-V steel
- Chrome plated
- Packing color box

ITEM NO.	SIZE	📦	🔪
HTCL1051	3"		20
HTCL1052	4"		20
HTCL1053	5"		10
HTCL1054	6"		12
HTCL1055	8"		5
HTCL1056	10"		4
HTCL1057	12"		2

# Hand Tools- Vice



## CASTING IRON ANVILS

- Polished working face
- Packed by color box

ITEM NO.	SIZE		
HTV1000	1kg		12
HTV1001	2kg		10
HTV1002	4kg		6
HTV1003	7kg		2
HTV1004	11kg		1
HTV1005	25kg		1
HTV1006	35kg		1
HTV1007	50kg		1
HTV1008	70kg		1



## BENCH VICE SWIVELED WITH ANVIL

- Swivel base with anvil
- Packed by color box
- Hardened and tempered jaws

ITEM NO.	SIZE		
HTV1009	75mm, 3"		4
HTV1010	100mm, 4"		2
HTV1011	125mm, 5"		2
HTV1012	150mm, 6"		2
HTV1013	200mm, 8"		1
HTV1014	250mm, 10"		1



## TABLE VICE

- Swivel base with arm
- Packed by color box
- Hardened and tempered jaws

ITEM NO.	SIZE		
HTV1015	50mm, 2"		10
HTV1016	65mm, 2.5"		10



## VICES FOR DRILL PRESS AMERICAN TYPE

- Hardened and tempered jaws
- Aluminum body
- Packed by color box

ITEM NO.	SIZE		
HTV1017	150mm, 2"		10



## VICES FOR DRILL PRESS AMERICAN TYPE

- Hardened and tempered jaws
- Packed by color box

ITEM NO.	SIZE		
HTV1018	2.5"		10
HTV1019	3"		10
HTV1020	4"		10
HTV1021	5"		6
HTV1022	6"		6



## QKF CROSS DRILL PRESS VICE

- Hardened and tempered jaws
- Packed by color box

ITEM NO.	SIZE		
HTV1023	3"		1
HTV1024	4"		1
HTV1025	5"		1
HTV1026	6"		1



## ANGLE GRINDER STAND

- For angle grinder 100mm
- Packed by color box

ITEM NO.	SIZE		
HTV1027	100mm		6



## ANGLE GRINDER STAND

- For angle grinder 115mm/125mm/230mm
- Packed by color box

ITEM NO.	SIZE		
HTV1028	115/125mm		10
HTV1029	230mm		6



## DRILL STAND

- height: 510mm
- Drillinf depth: 60mm
- Holdinh dia: 43mm
- Packed by color box

ITEM NO.	SIZE		
HTV1030	60		10

HAND TOOLS

POWER TOOL ACCESSORIES

CAR TOOLS

POWER TOOLS

AIR TOOLS

GARDEN TOOLS



### UTILITY KNIFE

- Material: zinc - alloy
- Packing: Color card
- Medium utility blade

ITEM NO.	SIZE	12	144
HTKN1000	19x61mm		



### HEAVY DUTY UTILITY KNIFE WITH 6PCS BLADES

- Material: zinc - alloy with TRP quick change blade
- 6pcs replace blade
- Packed double blister

ITEM NO.	SIZE	6	72
HTKN1001	19x61mm		

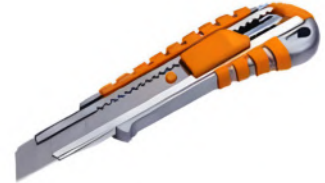

### 18MM KNIFE CUTTER

- Material: zinc - alloy with TRP, Iron frame chrome auto locking
- 16mm blade
- Packed double blister

ITEM NO.	SIZE	24	96
HTKN1002	18mm		



### 18MM KNIFE CUTTER WITH 3 BALDES

- Material: ABS shell with TRP coated, Iron frame , chrome auto locking
- 3pcs replaceable blade, 18mm blade
- Packed skin card

ITEM NO.	SIZE	24	144
HTKN1003	18mm		



### 18MM KNIFE CUTTER

- ABS plastic shell
- Iron frame, chrome auto locking
- 18mm blade
- Packed skin card

ITEM NO.	SIZE	24	144
HTKN1004	18mm		



### 9MM KNIFE CUTTER

- Stainless steel shell 9mm blade
- Display box packing

ITEM NO.	SIZE	36	432
HTKN1005	9mm		



### 18MM KNIFE CUTTER

- ABS plastic shell
- 18MM: blade
- Auto locking
- Packing: blister card

ITEM NO.	SIZE	14	144
HTKN1006	18mm		



### SAFE-RETRACTING KNIFE

- ABS shell
- Slide card
- Medium utility blade

ITEM NO.	SIZE	12	144
HTKN1007	19x61mm		



### UTILITY FOLDING KNIFE CUTTER

- Material: zinc alloy with TRP, quick change blade
- With 10 pcs blade medium utility blade
- Double blister

ITEM NO.	SIZE	10	60
HTKN1008	19x61mm		



### FOLDING POCKET KNIFE

- Stainless steel head
- Double blister packed
- Aluminum handle

ITEM NO.	SIZE	10	120
HTKN1009	205mm		



### 11 IN 1 MULTI FOLDING POCKET KNIFE

- Material: Aluminum handle+2CR13 Stainless steel parts
- Double blister packed

ITEM NO.	SIZE	16	48
HTKN1010	11 in 1		



### 9 IN 1 MULTI FOLDING POCKET KNIFE

- Material: Aluminum handle+2CR13 Stainless steel parts
- Double blister packed

ITEM NO.	SIZE	16	48
HTKN1011	9 in 1		

HAND TOOLS

POWER TOOL ACCESSORIES

CAR TOOLS

POWER TOOLS

AIR TOOLS

GARDEN TOOLS



# Hand Tools- Knife



**ELECTRICIAN'S KNIFE**  
 - Stainless steel, wooden handle  
 - Packing: slide card

ITEM NO.	SIZE	📦	🔪
HTKN1012	205mm	10	120



**ELECTRICIAN'S KNIFE**  
 - Stainless steel, wooden handle  
 - Packing: slide card

ITEM NO.	SIZE	📦	🔪
HTKN1013	195mm	12	72



**PLASTIC SCRAPER**  
 - Metal body TRP cover  
 - Chrome plated  
 - Packing: double blister

ITEM NO.	SIZE	📦	🔪
HTKN1014	107.5x52.5x18.5	12	240



**ALUMINUM SCRAPER**  
 - Aluminum alloy head and handle  
 - 100mm SK5 blade  
 - With blade sheath  
 - Packing: skin card

ITEM NO.	SIZE	📦	🔪
HTKN1015	310x110x28.5mm	10	100



**16PCS PRECISION CRAFT KNIFE KIT**

- Contents:
- 1pc 120mm-8mm Aluminum alloy handle
- 1pc 120mm-11mm Aluminum alloy handle
- 1pc-ABS+TPR Handle
- 13pcs SK5 blade
- Packing slide card

ITEM NO.	SIZE	📦	🔪
HTKN1016	16pcs	12	48



**PRECISION CRAFT KNIFE KIT**

- Precision knife
- Aluminum handle
- 18PCS interchangeable blades
- 2PCS ASS+TPR Hands
- 2PCS Aluminum Handle
- Packing slide card

ITEM NO.	SIZE	📦	🔪
HTKN1017	22pcs	120	6000



**10PCS 9MM BLADE**  
 -High quality carbon steel  
 - 10pcs blister card

ITEM NO.	SIZE	📦	🔪
HTKN1018	10pcs	10	400
HTKN1019	10pcs	25	250



**10PCS 18MM BLADE**  
 -High quality carbon steel  
 - 10pcs blister card

ITEM NO.	SIZE	📦	🔪
HTKN1020	10pcs	10	400
HTKN1021	10pcs	25	250



**10PCS MEDIUM UTILITY BLADE**  
 -High quality carbon steel  
 -Size 61x11mm  
 - 10pcs blister card

ITEM NO.	SIZE	📦	🔪
HTKN1022	10pcs	12	600
HTKN1023	10pcs	25	250

HAND TOOLS

POWER TOOL ACCESSORIES

CAR TOOLS

POWER TOOLS

AIR TOOLS

GARDEN TOOLS



**100PCS UTILITY KNIFE BLADE**

- Trimming knife blade dispenser
- Reversible two notch trimming knife blades
- Size: 61x19mm
- Manufactured from carbon steel
- Supplies in plastic dispenser
- Packing: slide card

ITEM NO.	SIZE	☞	☞
HTKN1024	100pcs	6	100



**AVIATION SNIP (RIGHT)**

- CRV steel drop-forged head
- Original finish
- Bi-color PVC soft grip
- Packed by half double blister

ITEM NO.	SIZE	☞	☞
HTSS1002	250mm, 10"	6	48



**TINMAN'S SNIP**

- Drop-forged carbon steel
- Bi-color dipped handle
- Packed with sliding card

ITEM NO.	SIZE	☞	☞
HTSS1005	10"	5	40



**ELECTRICIANS'S SCISSORS**

- Stainless steel blade
- Design for telecom and electrical applications
- Packed by sliding card

ITEM NO.	SIZE	☞	☞
HTSS1010	140mm, 5.5"	12	120



**AVIATION SNIP(LEFT)**

- CRV steel drop-forged head
- Original finish
- Bi-color PVC soft grip
- Packed by half double blister

ITEM NO.	SIZE	☞	☞
HTSS1000	250mm, 10"	6	48



**EXTRA LONG AVIATION SNIP (STRAIGHT)**

- CRV steel drop-forged head
- Original finish
- Bi-color PVC soft grip
- Packed by half double blister

ITEM NO.	SIZE	☞	☞
HTSS1003	300mm, 12"	5	40



**TINMAS'S SNIP**

- Drop-forged carbon steel
- Bi-color dipped handle
- Packed with sliding card

ITEM NO.	SIZE	☞	☞
HTSS1006	200mm 8"	6	36
HTSS1007	250mm 10"	5	20



**HOUSEHOLD SCISSORS**

- Stainless steel blade
- Packed by sliding card

ITEM NO.	SIZE	☞	☞
HTSS1011	200mm, 8"	10	160



**AVIATION SNIP (STRAIGHT)**

- CRV steel drop-forged head
- Original finish
- Bi-color PVC soft grip
- Packed by half double blister

ITEM NO.	SIZE	☞	☞
HTSS1001	250mm, 10"	6	48



**3PCS AVIATION SNIP(LEFT)**

- CRV steel drop-forged head
- Original finish
- Bi-color PVC soft grip
- Packed by half double blister

ITEM NO.	SIZE	☞	☞
HTSS1004	3pcs, 250mm, 10"	6	48



**TAILOR SCISSOR**

- Stainless steel blade
- Packed by color box

ITEM NO.	SIZE	☞	☞
HTSS1008	215mm, 8.5"	6	36
HTSS1009	250mm 10"	6	24



**HOUSEHOLD SCISSOR**

- Stainless steel blade
- Packed by sliding card

ITEM NO.	SIZE	☞	☞
HTSS1012	200mm, 8"	10	100
HTSS1013	250mm, 8.5"	10	100

HAND TOOLS

POWER TOOL ACCESSORIES

CAR TOOLS

POWER TOOLS

AIR TOOLS

GARDEN TOOLS

# Hand Tools- Scissors/Hacksaw



## HOUSEHOLD SCISSOR

- Stainless steel blade
- Packed by sliding card

ITEM NO.	SIZE	📦	📦
HTSS1014	200mm, 8"	12	144



## HEAVY DUTY HOUSEHOLD SCISSOR

- Stainless steel blade
- Packed by sliding card

ITEM NO.	SIZE	📦	📦
HTSS1015	190mm, 7.5"	12	96



## 11 IN 1 MULTI-FUNCTION PLIERS

- Stainless steel
- Aluminum handle polished surface
- With oxford bag
- Packing: double blister

ITEM NO.	SIZE	📦	📦
HTSS1016	11 in 1	6	36



## SQUARE TUBULAR HACKSAW

- Square lacquered steel tube bow frame
- Perfect ergonomic grip
- Plastic handshake material for the TPR
- Include 1pc saw blade
- Packed: color sleeve

ITEM NO.	SIZE	📦	📦
HTHS1000	300mm, 12"	6	36



## SQUARE TUBULAR HACKSAW

- Square lacquered steel tube bow frame
- Aluminum handlep
- Include 1pc saw blade
- Packed: color sleeve

ITEM NO.	SIZE	📦	📦
HTHS1001	300mm, 12"	6	36



## FLAT TUBULAR HACKSAW

- Square lacquered steel tube bow frame
- Wooden handle
- Include 1pc saw blade
- Packed: color sleeve

ITEM NO.	SIZE	📦	📦
HTHS1002	300mm, 12"	6	36



## SQUARE TUBULAR HACKSAW

- Square lacquered steel tube bow frame
- Aluminum handle
- Include 1pc saw blade
- Packed: color sleeve

ITEM NO.	SIZE	📦	📦
HTHS1003	300mm, 12"	6	36



## ADJUSTABLE HACKSAW FRAME

- Square lacquered steel tube bow frame
- Include 1pc saw blade
- Packed: color sleeve

ITEM NO.	SIZE	📦	📦
HTHS1004	200-300mm, 10"-12"	6	36



## MINI HACKSAW

- Aluminum handle
- Include 1pc saw blade
- Packed: color card

ITEM NO.	SIZE	📦	📦
HTHS1005	250mm, 10"	20	120
HTHS1006	300mm, 12"	20	120



## WIRE SAW

- Square lacquered steel tube bow frame
- Plastic handle
- Include 5pcs saw blade
- Packed: color steeve

ITEM NO.	SIZE	📦	📦
HTHS1007	125mm, 5"	6	72
HTHS1008	180mm, 7"	25	250



## MULTI FUNCTION HACKSAW WITH 3PCS BLADES

- Square lacquered steel tube bow frame
- Include 1pc saw blade
- ABS handle with TPR coating include 3pcs saw blade
- Packed: color sleeve

ITEM NO.	SIZE	📦	📦
HTHS1009	300mm, 12"	24	

HAND TOOLS

POWER TOOL ACCESSORIES

CAR TOOLS

POWER TOOLS

AIR TOOLS

GARDEN TOOLS



### 6PCS HAWKSAW BLADE SET

- Material: 65MN
- Size: 12" 1/2" 18T(2pcs), 12" 1/2" 24T(2pcs), 12" 1/2" 32T(2pcs)
- Thickness: 0.65mm
- Packing: plastic hanger

ITEM NO.	SIZE		
HTHS1010	6pcs	20	200



### 6PCS HAWKSAW BLADE SET

- Material: Bin-metal M2+D6A
- Size: 12" 1/2" 18T(2pcs), 12" 1/2" 24T(2pcs), 12" 1/2" 32T(2pcs)
- Thickness: 0.65mm
- Packing: plastic hanger

ITEM NO.	SIZE		
HTHS1011	6pcs	20	120



### 2PCS HAWKSAW BLADE

- Material: Bin-metal M2+D6A
- Size: 8T, 24T, 32T
- Thickness: 0.55mm
- Packing: plastic hanger

ITEM NO.	SIZE		
HTHS1012	2pcs	100	400



### 100PCS HAWKSAW BLADE

- Carbon steel
- Number of teeth: 24T
- 100pcs packed by plastic box
- Packing: color cable

ITEM NO.	SIZE		
HTHS1013	100pcs		10



### 100PCS HAWKSAW BLADE

- Carbon steel
- Number of teeth: 24T, 118T
- 100pcs packed by plastic box
- Packing: color cable

ITEM NO.	SIZE		
HTHS1014	100pcs		10



### GARDEN SAW BLADE

- A-type double side grinding teeth
- High frequency hardened
- 65Mn blade
- Packed: color sleeve

ITEM NO.	SIZE		
HTHS1015	450mm, 18"	100	1000
HTHS1016	530mm, 21"	100	1000
HTHS1017	610mm, 24"	100	1000
HTHS1018	760mm, 30"	100	1000



### FOLDABLE PRUNING SAW

- 7TPI 6Mn Blade
- Plastic safe hand protector
- Non-Displace curved cutting edge
- Precision ground aggressive pull out
- 65Mn blade
- Packed: slide card

ITEM NO.	SIZE		
HTHS1019	180mm, 7"	6	72
HTHS1020	200mm, 8"	6	60

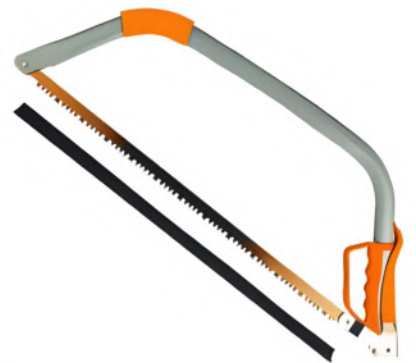

### BOW SAW

- Ground Cross Cut Teeth
- Impulse Hardened Teeth
- 65Mn Blade
- Dynamic Teeth Set
- Tubular Steel Framework
- Packed: color sleeve

ITEM NO.	SIZE		
HTHS1021	450mm, 18"	6	24
HTHS1022	530mm, 21"	6	24
HTHS1023	610mm, 24"	6	12
HTHS1024	760mm, 30"	6	12

HAND TOOLS

POWER TOOL ACCESSORIES

CAR TOOLS

POWER TOOLS

AIR TOOLS

GARDEN TOOLS

# Hand Tools- Hacksaw



## BOARD SAW

- 7TPI 65Mn blade
- With bi-color plastic handle
- Packed by half double blister

ITEM NO.	SIZE		
HTHS1025	150mm, 6"	6	60



## FOLDABLE SAW

- 7TPI 65Mn blade
- With bi-color plastic handle
- Packed by half double blister

ITEM NO.	SIZE		
HTHS1026	180mm, 7"	6	48



## TELESCOPIC GARDEN SAW

- Size: 6"
- Material: 65Mn, ABS handle blade locks in place for use medium to coarse cutting
- teeth pitch: 7TPI
- Packed by double blister

ITEM NO.	SIZE		
HTHS1027	150mm, 6"	12	48



## HAND SAW

- 7TPI
- 65Mn blade, heat treated
- With teeth protector
- ABS +TPR handle
- Packed by color sleeve

ITEM NO.	SIZE		
HTHS1028	12"	10	40
HTHS1029	14"	10	40
HTHS1030	16"	10	40
HTHS1031	18"	10	40
HTHS1032	20"	10	40
HTHS1033	22"	10	40
HTHS1034	24"	10	40



## HAND SAW

- 7TPI
- 65Mn blade, heat treated
- With teeth protector
- Wooden handle with soft grip
- Packed by color sleeve

ITEM NO.	SIZE		
HTHS1035	12"	10	40
HTHS1036	14"	10	40
HTHS1037	16"	10	40
HTHS1038	18"	10	40
HTHS1039	20"	10	40
HTHS1040	22"	10	40
HTHS1041	24"	10	40



## BACK SAW

- 12TPI
- 65Mn blade heat treated
- With teeth protector
- Packed: color sleeve

ITEM NO.	SIZE		
HTHS1042	250mm, 10"	72	
HTHS1043	300mm, 12"	72	
HTHS1044	350mm, 14"	72	



## COMPASS SAW

- 65Mn blade, heat treated
- With teeth protector
- Packed: color sleeve

ITEM NO.	SIZE		
HTHS1045	300mm, 12"	72	



## MITRE BOX AND BACK SAW SET

- 12TPI
- 65Mn blade, heat treated
- ABS body
- Packed: color sleeve

ITEM NO.	SIZE		
HTHS1046	300mm, 12"	10	20

HAND TOOLS

POWER TOOL ACCESSORIES

CAR TOOLS

POWER TOOLS

AIR TOOLS

GARDEN TOOLS

Industrial



GO-THROUGH WOOD CHISEL

- Drop forged chrome vanadium steel, heat treated
- Bi-color comfortable handle grip
- G0-through with end cap
- Polished & black finished
- Packing: double blister

ITEM NO.	SIZE	6	60
HTCH1000	6mm	6	60
HTCH1001	8mm	6	60
HTCH1002	10mm	6	60
HTCH1003	12mm	6	60
HTCH1004	14mm	6	60
HTCH1005	16mm	6	60
HTCH1006	18mm	6	60
HTCH1007	20mm	6	60
HTCH1008	22mm	6	60
HTCH1009	24mm	6	60
HTCH1010	30mm	6	60
HTCH1011	35mm	6	60
HTCH1012	40mm	6	60
HTCH1013	50mm	6	60

Industrial



4PCS WOOD CHISEL

- Drop forged chrome vanadium steel, heat treated
- Polished & black finished
- Bi-color comfortable handle grip
- Packing: double blister

ITEM NO.	SIZE	6	12
HTCH1014	6, 12, 19, 25mm	4	12

Industrial



4PCS WOOD CHISEL

- Drop forged chrome vanadium steel, heat treated
- Polished & black finished
- Bi-color comfortable handle grip
- Packing: double blister

ITEM NO.	SIZE	6	10
HTCH1015	6, 12, 19, 25mm	4	10

Industrial



POINT COLD CHISEL

- Drop forged chrome vanadium steel treated heated
- Bi-color comfortable handle grip
- Paint coating
- Packed: PP hanger & color sticker

ITEM NO.	SIZE	6	24
HTCH1016	4x16x250mm	6	24
HTCH1017	4x18x300mm	6	24

Industrial



FLAT COLD CHISEL

- Drop forged chrome vanadium steel treated heated
- Bi-color comfortable handle grip
- Paint coating
- Packed: PP hanger & color sticker

ITEM NO.	SIZE	6	24
HTCH1018	19x16x250mm	6	24
HTCH1019	19x18x300mm	6	24

Industrial



ELECTRICIANS BOLSTER WITH SAFETY GRIP

- Material: CR-V
- Power painting
- PP+TPR handle
- Packed: PP hanger & color sticker

ITEM NO.	SIZE	6	18
HTCH1020	76x19x279mm	6	18

FLAT COLD CHISEL

- Drop forged chrome vanadium steel treated heated
- Plastic handle grip
- Sandy finished
- Packed color sticker

ITEM NO.	SIZE	6	24
HTCH1021	19x16x250mm	6	24
HTCH1022	19x18x300mm	6	24

POINT COLD CHISEL

- Drop forged chrome vanadium steel treated heated
- Plastic handle grip
- Sandy finished
- Packed: color sticker

ITEM NO.	SIZE	6	24
HTCH1023	4x16x250mm	6	24
HTCH1024	4x18x300mm	6	24

HAND TOOLS

POWER TOOL ACCESSORIES

CAR TOOLS

POWER TOOLS

AIR TOOLS

GARDEN TOOLS

# Hand Tools- Punch



## 5PCS PUNCH & COLD CHISEL SET

- Drop forged chrome vanadium steel, heat treated
- Power coated
- 1pc cold chisel 13x10x150mm 1pc cape chisel: 5x10x150mm, 1pc pin punch: 8x10x150mm, 1pc taper punch: 2x10x150mm 1pc center punch: 3x10x150mm
- Packed: sliding card

ITEM NO.	SIZE	📦	📄
HTPU1000	5pcs	5	20



## 12PCS HALLOW PUNCH SET

- High quality carbon steel, treat heated polished
- Double blister packing

ITEM NO.	SIZE	📦	📄
HTPU1003	3, 4, 5, 6, 7, 8, 10, 11, 12, 14, 16, 19mm	5	20



## AUTOMATIC CENTER PUNCH

- Drop forged chrome vanadium steel, heat treated
- Material: CRV + copper
- Packed by sliding card
- SIZE: 6"

ITEM NO.	SIZE	📦	📄
HTPU1006	5"	120	
HTPU1007	6"	120	



## 14PCS PUNCH & CHISEL SET

- Drop forged chrome vanadium steel, heat treated
- Power coated
- 4PCS flat chisel: 6.4x100mm, 12.7x146mm, 15.8x162mm, 19x165mm,
- 2PCS Center punch: 9.5x114mm 2pcs
- 2PCS taper punch: 4x176mm, 4.8x226mm
- 6PCS Pin punch: 1.6x100mm, 2.4x100mm, 3.2x114mm, 4x125mm, 4.8x125mm, 6.4x140mm
- Packed: sliding card

ITEM NO.	SIZE	📦	📄
HTPU1001	14pcs	5	10



## 9PCS HALLOW PUNCH SET

- High quality carbon steel, treat heated polished
- Double blister packing

ITEM NO.	SIZE	📦	📄
HTPU1004	2.5, 3, 4, 5, 6, 7, 8, 9, 10mm	12	72



## 9PCS NUMBER PUNCH SET

- High quality carbon steel, heat treated, black finished
- Packed by color box packing

ITEM NO.	SIZE	📦	📄
HTPU1008	3mm	12	72
HTPU1009	6mm	25	50



## 6PCS PUNCH SET

- Drop forged chrome vanadium steel, heat treated
- 3pcs pin punch: 3x10x150mm, 5x10x150mm, 8x12x150mm
- 3pcs taper punch: 3x10x150mm, 5x10x150mm, 8x12x150mm
- Powder coated
- Packed: metal box & color sticker

ITEM NO.	SIZE	📦	📄
HTPU1002	6pcs	5	30



## 6PCS COLD CHISEL & PUNCHES SET

- Drop forged chrome vanadium steel, heat treated
- Bi-color handle
- 1pc cold chisel: 12x10x180mm
- 5pcs pin punch: 3x10x180mm, 4x10x180mm, 5x10x180mm, 6x10x180mm, 8x10x180mm
- Packing: plastic box

ITEM NO.	SIZE	📦	📄
HTPU1005	6pcs	5	10



## 27PCS LETTER PUNCH SET

- High quality carbon steel, heat treated, black finished
- Packed by color box packing

ITEM NO.	SIZE	📦	📄
HTPU1010	3mm	10	40
HTPU1011	6mm	10	20



## WOOD PLANE

- Iron plate body with surface coating
- Fully adjustable alloy steel blade hardened, tempered and fully ground
- Double color soft handle and guidance knob for user comfort
- Packed by color box

ITEM NO.	SIZE		
HTWP1000	90x51mm		12

## WOOD PLANE

- Gray cast iron body with precision milled base and face
- Fully adjustable alloy steel blade hardened, tempered and fully ground
- Plastic handle and guidance knob for user comfort
- Packed by color box

ITEM NO.	SIZE		
HTWP1001	90x51mm		12

## WOOD PLANE

- Iron plate body with surface coating
- Fully adjustable alloy steel blade hardened, tempered and fully ground
- Double color soft handle and guidance knob for user comfort
- Packed by color box

ITEM NO.	SIZE		
HTWP1002	190x51mm		12



## BLADE PLANE

- Fully adjustable alloy steel blade hardened, tempered and fully ground
- Packed by double blister

ITEM NO.	SIZE		
HTWP1003	190x51mm		120

## BLADE PLANE

- Fully adjustable alloy steel blade hardened, tempered and fully ground
- Packed by double blister

ITEM NO.	SIZE		
HTWP1004	90x51mm		120



## WRECKING BAR

- High quality carbon steel heat treated
- Paint coating
- Packed by color blister

ITEM NO.	SIZE		
HTWB1000	600X30X17mm		12
HTWB1001	750x30x17mm		10
HTWB1002	900x30x17mm		5

## WRECKING BAR

- High quality carbon steel heat treated
- Paint coating
- Packed by color blister

ITEM NO.	SIZE		
HTWB1003	160X25X4mm		24
HTWB1004	375x35x6mm		12
HTWB1005	450x35x6mm		12

## WRECKING BAR

- High quality carbon steel heat treated
- Paint coating
- Packed by color blister

ITEM NO.	SIZE		
HTWB1006	600mm		12
HTWB1007	900mm		6



## HAT STEEL FILES

- Flat
- T12 carbon steel
- Packed: color label

ITEM NO.	SIZE		
HTF1000	160mm, 6"		400
HTF1001	200mm, 8"		200
HTF1002	250mm, 10"		100

## HALF ROUND STEEL FILES

- Half round
- T12 carbon steel
- Packed: color label

ITEM NO.	SIZE		
HTF1003	160mm, 6"		400
HTF1004	200mm, 8"		200
HTF1005	250mm, 10"		100

## ROUND STEEL FILES

- Round
- T12 carbon steel
- Packed: color label

ITEM NO.	SIZE		
HTF1006	160mm, 6"		400
HTF1007	200mm, 8"		200
HTF1008	250mm, 10"		100

HAND TOOLS

POWER TOOL ACCESSORIES

CAR TOOLS

POWER TOOLS

AIR TOOLS

GARDEN TOOLS



# Hand Tools- Files



## TRIANGULAR STEEL FILES

- Triangular  
- T12 steel

ITEM NO.	SIZE	📦	📦
HTF1009	160mm, 6"	400	
HTF1010	200mm, 8"	200	
HTF1011	250mm, 10"	100	



## SQUARE STEEL FILES

- Triangular  
- T12 steel

ITEM NO.	SIZE	📦	📦
HTF1012	160mm, 6"	400	
HTF1013	200mm, 8"	200	
HTF1014	250mm, 10"	100	



## HAT WOOD RASP

- Flat  
- Packed by color label

ITEM NO.	SIZE	📦	📦
HTF1015	160mm, 6"	400	
HTF1016	200mm, 8"	200	
HTF1017	250mm, 10"	100	



## HALF ROUND WOOD RASP

- Half round  
- Packed by color label

ITEM NO.	SIZE	📦	📦
HTF1018	160mm, 6"	400	
HTF1019	200mm, 8"	200	
HTF1020	250mm, 10"	100	



## ROUND WOOD RASP

- Round  
- Packed by color label

ITEM NO.	SIZE	📦	📦
HTF1021	160mm, 6"	400	
HTF1022	200mm, 8"	200	
HTF1023	250mm, 10"	100	



## TRIANGULAR WOOD RASP

- Triangular  
- Packed by color label

ITEM NO.	SIZE	📦	📦
HTF1024	Ø4.0	400	
HTF1025	Ø4.8	200	
HTF1026	Ø5.5	100	



## FLAT STEEL FILES WITH HANDLE

- Flat  
- T12 carbon steel heat treated

- Bi-color plastic handle  
- Packed by sliding card

ITEM NO.	SIZE	📦	📦
HTF1027	6"	10	60
HTF1028	8"	10	60
HTF1029	10"	10	60



## HALF ROUND STEEL FILES WITH HANDLE

- Half round  
- T12 carbon steel heat treated

- Bi-color plastic handle  
- Packed by sliding card

ITEM NO.	SIZE	📦	📦
HTF1030	6"	10	60
HTF1031	8"	10	60
HTF1032	10"	10	60



## ROUND STEEL FILES WITH HANDLE

- Round  
- T12 carbon steel heat treated

- Bi-color plastic handle  
- Packed by sliding card

ITEM NO.	SIZE	📦	📦
HTF1033	6"	10	60
HTF1034	8"	10	60
HTF1035	10"	10	60



## TRIANGULAR STEEL FILES WITH HANDLE

- Triangular  
- T12 carbon steel heat treated

- Bi-color plastic handle  
- Packed by sliding card

ITEM NO.	SIZE	📦	📦
HTF1036	6"	10	60
HTF1037	8"	10	60
HTF1038	10"	10	60



## SQUARE STEEL FILES WITH HANDLE

- Square  
- T12 carbon steel heat treated

- Bi-color plastic handle  
- Packed by sliding card

ITEM NO.	SIZE	📦	📦
HTF1039	6"	10	60
HTF1040	8"	10	60
HTF1041	10"	10	60



## FLAT WOOD RASP WITH HANDLE

- Flat  
- High quality carbon steel heat treated

- Bi-color plastic handle  
- Packed by sliding card

ITEM NO.	SIZE	📦	📦
HTF1042	6"	10	60
HTF1043	8"	10	60
HTF1044	10"	10	60

HAND TOOLS

POWER TOOL ACCESSORIES

CAR TOOLS

POWER TOOLS

AIR TOOLS

GARDEN TOOLS



**HALF ROUND WOOD RASP WITH HANDLE**

- Half round
- High quality carbom steel treated heated
- Bi-color plastic handle
- Packed by sliding card

ITEM NO.	SIZE	📦	🔪
HTF1045	6"	10	60
HTF1046	8"	10	60
HTF1047	10"	10	60



**ROUND WOOD RASP WITH HANDLE**

- Round
- High quality carbom steel treated heated
- Bi-color plastic handle
- Packed by sliding card

ITEM NO.	SIZE	📦	🔪
HTF1048	6"	10	60
HTF1049	8"	10	60
HTF1050	10"	10	60



**3PCS STEEL FILES**

- Flat half round, Round
- T12 carbon steel treated heated
- Bi-color plastic handle
- Double blister

ITEM NO.	SIZE	📦	🔪
HTF1051	10"	4	20

**3PCS WOOD RASP**

- Flat half round, Round
- High quality carbon steel heat treated
- Bi-color plastic handle
- Double blister

ITEM NO.	SIZE	📦	🔪
HTF1052	10"	4	20

**6PCS NEEDLE FILES SET**

- Flat, flat warding, square, triangular, round, half round
- Bearing ball steel heat treated
- Bi-color plastic handle
- Plastic box packing

ITEM NO.	SIZE	📦	🔪
HTF1053	3x140"	3	30



**6PCS NEEDLE FILES SET**

- Flat half round, Round
- Bi-color plastic handle
- T12 carbon steel treated heated
- Double blister

ITEM NO.	SIZE	📦	🔪
HTF1054	3X140	12	120

**5PCS DIAMOND NEEDLE FILES SET**

- Flat, flat warding, square, triangular, round, half round
- Bearing ball steel heat treated
- Fine diamond grit 150 grit
- Packed by sliding card

ITEM NO.	SIZE	📦	🔪
HTF1055	3X140	12	120

**UNIVERSAL BRUSH**

- Steel wire
- Plastic handle
- Packed by hand bag

ITEM NO.	SIZE	📦	🔪
HTBR1000	250mm,10"	12	120



**WIRE BRSH**

- Staight and black wire
- Packed ny hand bag

-Wooden handle

ITEM NO.	SIZE	📦	🔪
HTBR1001	3lines	12	120
HTBR1002	4lines	12	120
HTBR1003	5lines	12	120

**WIRE BRUSH**

- Straight and black wire
- Packed by hand bag

-Plastic handle

ITEM NO.	SIZE	📦	🔪
HTBR1004	4x16	12	96

**WIRE BRUSH**

- Straight and black wire
- Packed by hand bag

-Plastic handle

ITEM NO.	SIZE	📦	🔪
HTBR1005	3x19	12	72

HAND TOOLS

POWER TOOL ACCESSORIES

CAR TOOLS

POWER TOOLS

AIR TOOLS

GARDEN TOOLS

# Hand Tools - Wire Brush/Paint Roller



## WIRE BRUSH

- Straight and black wire
- Plastic handle
- Packed by hand bag

ITEM NO.	SIZE	📦	👤
HTBR1006	4x18	12	96



## WIRE BRUSH

- Straight and black wire
- Plastic handle
- Packed by hand bag

ITEM NO.	SIZE	📦	👤
HTBR1007	9x20	12	96



## 3PCS WIRE BRUSH SET

- Straight and black wire
- Brass, stainless steel, nylon
- Plastic handle
- Packed by hand bag

ITEM NO.	SIZE	📦	👤
HTBR1008	3pcsx9"	12	48



## PAINT BRUSH

- Flat paint brushes
- PET & white bristle in chrome plated ferrule
- Wooden handle
- Packed by PVC bag with color label

ITEM NO.	SIZE	📦	👤
HTBR1009	1"		1200
HTBR1010	1.5"		1200
HTBR1011	2"		400
HTBR1012	2.5"		480
HTBR1013	3"		360
HTBR1014	4"		280



## PAINT BRUSH

- Flat paint brushes
- PET & white bristle in chrome plated ferrule
- Wooden handle
- Packed by PVC bag with color label

ITEM NO.	SIZE	📦	👤
HTBR1015	1"		1200
HTBR1016	1.5"		1200
HTBR1017	2"		400
HTBR1018	2.5"		480
HTBR1019	3"		360
HTBR1020	4"		280



## PAINT ROLLER

- Material: polyester and acrylic
- Convenient and fast change the roller cover
- Using for outside wall and coarse wall surface
- Packed by poly bag

ITEM NO.	SIZE	📦	👤
HTBR1021	9"		48



## PAINT ROLLER

- Material: acrylic
- Convenient and fast change the roller cover
- Using for outside wall and coarse wall surface
- Packed by poly bag

ITEM NO.	SIZE	📦	👤
HTBR1022	9"		48



## ROLLER COVER

- Material: acrylic
- Convenient and fast change the roller cover
- Using for outside wall and coarse wall surface
- Packed by poly bag

ITEM NO.	SIZE	📦	👤
HTBR1023	9"		120



## ROLLER COVER

- Material: acrylic
- Convenient and fast change the roller cover
- Using for outside wall and coarse wall surface
- Packed by poly bag

ITEM NO.	SIZE	📦	👤
HTBR1024	4"		200



## ROLLER COVER

- Material: Polyester and acrylic
- Convenient and fast change the roller cover
- Using for outside wall and coarse wall surface
- Packed by poly bag

ITEM NO.	SIZE	📦	👤
HTBR1025	9"		120



## ROLLER COVER

- Material: Polyester and acrylic
- Convenient and fast change the roller cover
- Using for outside wall and coarse wall surface
- Packed by poly bag

ITEM NO.	SIZE	📦	👤
HTBR1026	4"		200



## PAINT ROLLER

- Material: acrylic
- Convenient and fast change the roller cover
- Using for outside wall and coarse wall surface
- Packed by poly bag

ITEM NO.	SIZE	📦	👤
HTBR1027	4"		48

HAND TOOLS

POWER TOOL ACCESSORIES

CAR TOOLS

POWER TOOLS

AIR TOOLS

GARDEN TOOLS



## PAINT ROLLER

- Material: polyester and acrylic
- Convenient and fast change the roller cover
- Using for outside wall and coarse wall surface
- Packed by poly bag

ITEM NO.	SIZE		
HTBR1028	4"	48	



## PAINT TRAY

- Plastic material
- Packed by color label

ITEM NO.	SIZE		
HTBR1029	365x275x60mm*	72	



## 6PCS PAINT TOOL SET

- 3pcs 4" foam roller brush
- 1pc roller frame
- 1pc foam brush
- 1pc plastic tray
- Packed by hot shrink with color label

ITEM NO.	SIZE		
HTBR1030	6pcs	72	



## PAINT TRAY

- Plastic material
- Packed by sliding label

ITEM NO.	SIZE		
HTBR1031	4"	96	



## 3PCS 4" PAINT TOOLS KIT

- 1pc 4" polyester roller
- 4" roller frame
- 9" plastic tray
- Packed by hot shrink with color label

ITEM NO.	SIZE		
HTBR1032	4x3pcs	48	



## 8PCS 4" PAINT TOOLS KIT

- 8PCS 4" PAINT TOOLS KIT
- 6pcs 4" polyester roller
- 4" roller frame
- 4" plastic tray
- Packed by hot shrink with color label

ITEM NO.	SIZE		
HTBR1033	4x8pcs	48	



## 3PCS 9" PAINT TOOLS KIT

- 1pc 9" polyester roller
- 9" roller frame
- 9" plastic tray
- Packed by hot shrink with color label

ITEM NO.	SIZE		
HTBR1034	9x3pcs	12	



## 7PCS 9" PAINT TOOLS KIT

- 5pcs 9" polyester roller
- 9" roller frame
- 9" plastic tray
- Packed by hot shrink with color label

ITEM NO.	SIZE		
HTBR1035	9x7pcs	12	



## 12PCS 9" PAINT TOOLS KIT

- 6pcs 4" polyester roller
- 3pcs 9" polyester roller
- 4" roller frame
- 9" roller frame
- 9" Plastic tray
- Packed by hot shrink with color label

ITEM NO.	SIZE		
HTBR1036	12pcs	12	



## GLASS CUTTER

- Wooden handle
- High quality blade
- Packed by sliding card

ITEM NO.	SIZE		
HTGC1000	1#	6	120



## OILING & HOBBING GLASS CUTTER

- Copper handle
- Chrome finished
- Packed by sliding card

ITEM NO.	SIZE		
HTGC1001	59	6	120



## SIX WHEELS GLASS CUTTER

- Wooden handle
- With 6pcs wheels blade
- Chrome finished
- Packed by sliding card

ITEM NO.	SIZE		
HTGC1002	100mm	6	120

HAND TOOLS

POWER TOOL ACCESSORIES

CAR TOOLS

POWER TOOLS

AIR TOOLS

GARDEN TOOLS

# Hand Tools - Tile Cutter



## TILE CUTTER

- Replaceable cutting blade : Ø15xØ6x1.5mm
- Max cutting: 10mm
- Packed by color box

ITEM NO.	SIZE		
HTTC1000	400mm	4	



## 3 IN 1 TILE CUTTER

- Replaceable cutting blade : Ø15xØ6x1.5mm
- Max cutting: 10mm
- Packed by color box

ITEM NO.	SIZE		
HTTC1001	400mm	4	



## HEAVY DUTY TILE CUTTER

- Replaceable cutting blade : Ø16xØ6x3mm
- Max cutting: 12mm
- Packed by color box

ITEM NO.	SIZE		
HTTC1002	600mm	2	



## TILE CUTTER

- Replaceable cutting blade : YO6X Ø22xØ6x6mm
- Max cutting: 12mm
- Packed by color box

ITEM NO.	SIZE		
HTTC1003	900mm	2	



## MITRE SAW

- Adjustable cutting angle
- Packed by box color

ITEM NO.	SIZE		
HTTC1004	550mm	1	
HTTC1005	600mm	1	



## BLADE FOR TILE CUTTER

- High quality TCT material : YO6X
- Packed by double blister card

ITEM NO.	SIZE		
HTTC1006	Ø15x Ø6x1.5mm	10	



## TILE PLIERS

- Black oxide
- Aluminum breaking bar and PVC hand grip
- For scoring and snapping ceramic wall tiles
- Thickness of the metal sheet 2.5mm
- Tangsten corbide cutting wheel Ø13x6x1
- Packed by sliding card

ITEM NO.	SIZE		
HTTC1007	200mm, 8"	6	36



## HEAVY DUTY TILE NIBBLER WITH NORMAL HEAD

- For nibbling and trimming ceramic tiles of any required shapes up to 12mm thick

ITEM NO.	SIZE		
HTTC1008	200mm, 8"	6	36



## KEEL FORCEPS

- Material carbon steel
- Fixed bolt
- Rubber handle
- Packed by color ox

ITEM NO.	SIZE		
HTTC1009		6	24



### ALUMINUM SINGLE SUNCTION LIFT

- Material : Aluminum and Rubber -Packed by hand tag

ITEM NO.	SIZE		
HTSC1000	4"		48



### ALUMINUM SINGLE DOUBLE HEAD SUNCTION LIFT

- Material : Aluminum and Rubber -Packed by hand tag

ITEM NO.	SIZE		
HTSC1001	2x4"		24



### ALUMINUM THREE SUNCTION LIFT

- Material : Aluminum and Rubber -Packed by hand tag

ITEM NO.	SIZE		
HTSC1002	3x4"		12



### SINGLE SUNCTION LIFT

- Material : ABS and Rubber -Packed by hand tag

ITEM NO.	SIZE		
HTSC1003	4"		48



### DOUBLE HEAD SUNCTION LIFT

- Material : ABS and Rubber -Packed by hand tag

ITEM NO.	SIZE		
HTSC1004	2x4"		24



### THREE HEAD SUNCTION LIFT

- Material : ABS and Rubber -Packed by hand tag

ITEM NO.	SIZE		
HTSC1005	3x4"		12



### CAULKING GUN

- Pressed steel  
- Packed with hang tag

ITEM NO.	SIZE		
HTSC1006	225mm,9"		24



### CAULKING GUN

- Alluminum body, steel trigger  
- Packed with hang tag

ITEM NO.	SIZE		
HTSC1007	225mm,9"		36



### HEAVY DUTY CAULKING GUN

- Alluminum body, aluminum trigger  
- Packed with hang tag

ITEM NO.	SIZE		
HTSC1008	225mm,9"		24

HAND TOOLS

POWER TOOL ACCESSORIES

CAR TOOLS

POWER TOOLS

AIR TOOLS

GARDEN TOOLS

# Hand Tools - Caulking Gun/ Scraper



## PROFESSIONAL CAULKING GUN

- Aluminum tube body with shaft pusher
- Heavy duty aluminum handles
- with 1pc plastic adaptor
- Packed with hang tag

ITEM NO.	SIZE		
HTCS1000	225mm,9"		12
HTCS1001	375mm,15"		12



## FOAM GUN

- Adaptor aluminum, gun body aluminum, gasket rubbers regulation wheel brass, barrel steel, needle steel, nozzle brass, trigger steel handle PP
- Packed with color box

ITEM NO.	SIZE		
HTCS1002			20



## FOAM GUN

- Adaptor zinc gun body aluminum gasket nut brass regulation wheel PP, barrel steel, needle steel, nozzle brass, trigger steel, handle PP
- Packed with color box

ITEM NO.	SIZE		
HTCS1003			20



## PAINT MIXER

- Carbon steel with powder coating
- Rubber hanging hole
- Packed by plastic hanging hole

ITEM NO.	SIZE		
HTCS1004	400x800x8mm		50
HTCS1005	600x100x10mm		50



## 3PCS CHALK LINE REEL

- Contain: 1pc chalk Reel, 1pc chalk, 1pc mini level
- Line Size: 30m
- Packed by double blister

ITEM NO.	SIZE		
HTCS1006	3pcs	5	40



## 6PCS CARPENTER PENCIL

- Oval
- 6pcs packed by blister card

ITEM NO.	SIZE		
HTCS1007	12x7.4x176mm	20	120



## WALL SCRAPPER

- #50 carbon steel heat treated
- Full polished
- Wooden handle
- Packed with color label

ITEM NO.	SIZE		
HTCS1008	30mm		240
HTCS1009	50mm		240
HTCS1010	80mm		240
HTCS1011	100mm		240



## WALL SCRAPPER

- #50 carbon steel heat treated
- Mirror polished
- Wooden handle
- Packed with color label

ITEM NO.	SIZE		
HTCS1012	30mm		120
HTCS1013	50mm		120
HTCS1014	60mm		120
HTCS1015	80mm		120
HTCS1016	100mm		120
HTCS1017	120mm		120
HTCS1018	140mm		120



## 3PCS WALL SCRAPPER SET

- #50 carbon steel
- Fine polished
- Wooden handle
- Size: 30mm, 40mm, 50mm
- Packed with color laber

ITEM NO.	SIZE		
HTCS1019	3pcs		80

HAND TOOLS

POWER TOOL ACCESSORIES

CAR TOOLS

POWER TOOLS

AIR TOOLS

GARDEN TOOLS



### WALL SCRAPPER

- #60 carbon steel heat treated
- Mirror polished
- Bi-color TPR handle
- Packing: color label

ITEM NO.	SIZE	📦	🔧
HTST1001	40mm, 1.5"		240
HTST1002	60mm, 2.5"		240
HTST1003	80mm, 3"		240
HTST1004	100mm, 4"		240
HTST1005	125mm, 5"		120
HTST1006	150mm, 6"		120
HTST1007	200mm, 8"		120
HTST1008	250mm, 10"		120



### MULTI-PURPOSE SCRAPPER

- #60 carbon steel, heat treated
- Mirror polished
- Bi-color TPR handle
- Packing: color label

ITEM NO.	SIZE	📦	🔧
HTST1009	2-1/2"		240



### TAPPING TAPING KNIFE

- #60 carbon steel heat treated
- Fire polished
- Wooden handle
- Packing: color label

ITEM NO.	SIZE	📦	🔧
HTST1010	140mm		240
HTST1011	160mm		240
HTST1012	180mm		240
HTST1013	200mm		240
HTST1014	220mm		220



### BRICKLAYING TROWEL

- Plastic handle
- Material: #50 carbon steel
- Packing: color label

ITEM NO.	SIZE	📦	🔧
HTST1015	120mm		72
HTST1016	140mm		72
HTST1017	160mm		72
HTST1018	180mm		72
HTST1019	200mm		72
HTST1020	220mm		72



### BRICKLAYING TROWEL

- Plastic handle
- Material: #50 carbon steel
- Common polished
- Packing: color label

ITEM NO.	SIZE	📦	🔧
HTST1021	5"		72
HTST1022	6"		72
HTST1023	7"		72
HTST1024	8"		72
HTST1025	10"		72
HTST1026	12"		72



### BRICKLAYING TROWEL

- Plastic handle
- Material: #50 carbon steel
- Packing: color label

ITEM NO.	SIZE	📦	🔧
HTST1027	140mm		72
HTST1028	160mm		72
HTST1029	180mm		72
HTST1030	200mm		72
HTST1031	220mm		72



### BRICKLAYING TROWEL

- Wooden handle
- Material: #50 carbon steel
- Packing: color label

ITEM NO.	SIZE	📦	🔧
HTST1032	130mm, 5"		120
HTST1033	150mm, 6"		120
HTST1034	175mm, 7"		120
HTST1035	200mm, 8"		120
HTST1036	250mm, 10"		120
HTST1037	300mm, 12"		120



### PLASTERING TROWEL

- Wooden handle
- Stainless steel
- Packing: color label

ITEM NO.	SIZE	📦	🔧
HTST1038	280x115mm		60
HTST1039	280x120mm		60
HTST1040	280x130mm		60



### PLASTERING TROWEL

- Wooden handle
- Stainless steel
- With tooth: 10x10mm
- Packing: color label

ITEM NO.	SIZE	📦	🔧
HTST1041	280x115mm		60
HTST1042	280x120mm		60
HTST1043	280x130mm		60

HAND TOOLS

POWER TOOL ACCESSORIES

CAR TOOLS

POWER TOOLS

AIR TOOLS

GARDEN TOOLS



# Hand Tools - Scraper & Trowel



## TROWEL

- Plastic handle
- Material: #50 carbon steel
- Packing: color label

ITEM NO.	SIZE		
HTST1044	120mm		72
HTST1045	140mm		72
HTST1046	160mm		72
HTST1047	180mm		72
HTST1048	220mm		72



## TROWEL

- Plastic handle
- Material: #50 carbon steel
- Packing: color label

ITEM NO.	SIZE		
HTST1049	4-1/2"		72
HTST1050	5"		72
HTST1051	6"		72
HTST1052	7"		72



## TROWEL

- Plastic handle
- Material: #50 carbon steel
- Packing: color label

ITEM NO.	SIZE		
HTST1053	180MM		72



## TROWEL

- Wood handle
- Material: #50 carbon steel
- Packing: color label

ITEM NO.	SIZE		
HTST1054	120mm		72
HTST1055	140mm		72
HTST1056	160mm		72
HTST1057	180mm		72
HTST1058	200mm		72
HTST1059	220mm		72



## TROWEL

- Wood handle
- Material: #50 carbon steel
- Packing: color label

ITEM NO.	SIZE		
HTST1060	120mm		72
HTST1061	140mm		72
HTST1062	160mm		72
HTST1063	180mm		72



## TAPING KNIFE

- Plastic handle
- Material: #50 carbon steel
- Packing: color label

ITEM NO.	SIZE		
HTST1064	8"(200mm)		96
HTST1065	10"(250mm)		96
HTST1066	12"(300mm)		96
HTST1067	16"(400mm)		72
HTST1068	20"(500mm)		46
HTST1069	24"(600mm)		36



## PLASTERING TROWEL

- Plastic handle
- Stainless steel
- Packing: color label

ITEM NO.	SIZE		
HTST1070	280x115mm		60
HTST1071	280x120mm		60
HTST1072	280x130mm		60



## PLASTERING TROWEL

- Wooden handle
- Stainless steel
- With tooth: 10x10mm
- Packing: color label

ITEM NO.	SIZE		
HTST1073	280x115mm		60
HTST1074	280x120mm		60
HTST1075	280x130mm		60



## FOAM TROWEL

- PS Plastic handle
- Rubber Base
- Packing: color label

ITEM NO.	SIZE		
HTST1076	250x95x13mm		60

HAND TOOLS

POWER TOOL ACCESSORIES

CAR TOOLS

POWER TOOLS

AIR TOOLS

GARDEN TOOLS

# Hand Tools - Tool Box



## TOOL BAG

- Packed by hang tag

ITEM NO.	SIZE		
HTTB1000	280x300mm	20	



## TOOL BAG

- Packed by hang tag

ITEM NO.	SIZE		
HTTB1001	350x180x270mm	8	



## TOOL BAG

- Packed by hang tag

ITEM NO.	SIZE		
HTTB1002	41x22.5x27cm	1	



## TOOL BAG

- Packed by

ITEM NO.	SIZE		
HTTB1003	335x185x130mm	20	
HTTB1004	415x210x190mm	12	
HTTB1005	480x250x230mm	9	



## TOOL BAG

- Packed by color sticker

ITEM NO.	SIZE		
HTTB1006	335x185x130mm	9	
HTTB1007	415x210x190mm	6	
HTTB1008	480x250x230mm	4	



## HARDWARE BOX

- Packed by color sticker

ITEM NO.	SIZE		
HTTB1009	320x225x60mm	20	
HTTB1010	360x310x70mm	16	
HTTB1011	450x360x80mm	8	



## DOUBLE E-SIDE HARDWARE BOX

- Packed by color sticker

ITEM NO.	SIZE		
HTTB1012	310X260X75mm	16	



## TOOL BOX

- Packed by color sticker

ITEM NO.	SIZE		
HTTB1013	530x200x200mm	1	



## STAINLESS TOOL BOX

- Packed by color sticker

ITEM NO.	SIZE		
HTTB1014	365x185x170mm	8	
HTTB1015	410x215x185mm	6	
HTTB1016	450x250x195mm	6	



## DOUBLE E-SIDE HARDWARE BOX

- Material: Steel plate  
- Packed by color sticker

ITEM NO.	SIZE		
HTTB1017	53x23x18cm	6	



## ALUMINUM TOOL BOX

- Packed by color sticker

ITEM NO.	SIZE		
HTTB1018	430X310X125mm	3	



## TOOL TROLLEY

- Packed by color box

ITEM NO.	SIZE		
HTTB1019	700X350X760cmm	1	

HAND TOOLS

POWER TOOL ACCESSORIES

CAR TOOLS

POWER TOOLS

AIR TOOLS

GARDEN TOOLS



**ALUMINUM TOOL BOX WITH TROLLEY**

- Packed by color sticker

ITEM NO.	SIZE		
HTTB1020	380x270x685mm		1



**FOLDABLE HAND TRUCK**

- Material frame: Alum. tube foot plate: Alum
- Overall size: 410x385x995mm
- Overall size folded: 85x385x640mm
- Foot plate: 280x385mm
- Capacity: 70kgs
- Packed by color box

ITEM NO.	SIZE		
HTHT1000	70kgs		1



**TOOL BOX**

- Main body: PP+sheet iron
- Trolley: ABS + aluminum alloy
- Packed by color sticker

ITEM NO.	SIZE		
HTTB1021	520x320x720mm		1



**FOLDABLE HAND TRUCK**

- Foldable size: 190x400x710mm
- Plate form: 240x355mm
- Overall size folded: 420x400x1080mm
- Capacity: 90kgs
- Packed by color box

ITEM NO.	SIZE		
HTHT1001	90kgs		1



**STEEL PLATFORM HAND TRUCK**

- Material: all sheet
- foldable size: 730x480x210mm
- Overall size folded: 730x480x660mm
- Plate form: 730x480mm
- Capacity: 150kgs
- Packed by color box

ITEM NO.	SIZE		
HTHT1002	150kgs		1



**STEEL PLATFORM HAND TRUCK**

- Material: Aluminum
- Product size: 117x48x49cm
- Wheel: 10x3.00-4
- Capacity: 200kgs
- Packed by color sticker

ITEM NO.	SIZE		
HTHT1003	200kgs		1



**STEEL PLATFORM HAND TRUCK**

- Material: iron tube
- Product size: 131x55x46cm
- Wheel: 10x3.5-4
- Capacity: 200kgs
- Packed by color sticker

ITEM NO.	SIZE		
HTHT1004	200kgs		1



**FOLDABLE HAND TRUCK**

- Material: iron tube
- Product size: 112x48x35cm
- Wheel: 10x3.00-4
- Capacity: 200kgs
- Packed by color sticker

ITEM NO.	SIZE		
HTHT1005	200kgs		1

HAND TOOLS

POWER TOOL ACCESSORIES

CAR TOOLS

POWER TOOLS

AIR TOOLS

GARDEN TOOLS



### MOVING TROLLEY

- Material: MDF
- Product size: 39\*39\*41cm
- Load capacity: 200kgs
- Packing color box

ITEM NO.	SIZE		
HTOT1000	39x39x41cm		1



### MOVING TROLLEY

- Material: MDF
- Product size: 57.5\*29\*11cm
- Load capacity: 200kgs
- Packing color box

ITEM NO.	SIZE		
HTOT1001	57.5x29x11cm		1



### MOVING TROLLEY

- Product size: 30x30x5cm
- Material: steel
- Capacity: 60kgs
- Safety locking wheels brake
- Packing: color box

ITEM NO.	SIZE		
HTOT1002	30x30x5cm		1

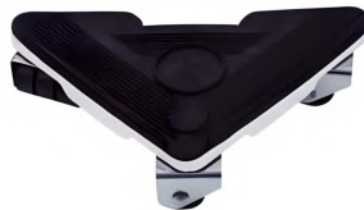

### MOVING TROLLEY

- Product size: 17.1\*17.1\*23cm
- Material: steel
- Capacity Loading: 200kgs
- Packing: color box

ITEM NO.	SIZE		
HTOT1003	17.1x17.1x23cm		1



### MOVING TROLLEY

- Capacity: 150kgs
- Material: ABS + PP
- Packing: color box

ITEM NO.	SIZE		
HTOT1004	105X80X22mm		1



### MULTI PURPOSE LADDER

- Material frame: Alum.
- Packed by shrink wrapping to wrap the color cover

ITEM NO.	SIZE		
HTOT1005	4x2 steps		1
HTOT1006	4x3 steps		1
HTOT1007	4x4 steps		1
HTOT1008	4x5 steps		1



### JOINT TELESCOPIC LADDER

- Material frame: Alum.
- Packed by color box

ITEM NO.	SIZE		
HTOT1009	3.2m		1
HTOT1010	3.8m		1
HTOT1011	4.4m		1
HTOT1012	5m		1



### TELESCOPIC LADDER

- Material frame: Alum.
- Packed by color box

ITEM NO.	SIZE		
HTOT1013	2m		1
HTOT1014	2.6m		1
HTOT1015	2.9m		1
HTOT1016	3.2m		1
HTOT1017	3.8m		1
HTOT1018	4.4m		1

HAND TOOLS

POWER TOOL ACCESSORIES

CAR TOOLS

POWER TOOLS

AIR TOOLS

GARDEN TOOLS



**17PCS TOOL SET**

- 1pc 6" combination pliers
- 1pc 8OZ claw hammer
- 1pc 6" adjustable wrench
- 1pcs bits holder
- 12pcs bits: SL: 3, 4, 5 PH: 1, 2, 3, T10, 15, 20, H4, 5, 6
- 1pc hammer cover

ITEM NO.	SIZE		
HTS1000	17pcs		12



**68PCS TOOL SET**

- 6 pcs L-socket wrench
- 8 pcs combination wrench
- 1 pc 10" adjustable wrench
- 8 pcs torx key (T9-T40)
- 8 pcs hex key(2.5-10mm)
- 1 pc 10" water pump pliers
- 1 pc 18mm knife
- 10 pcs 18mm knife blades
- 1 pc 6" combination pliers
- 1 pc 6" diagonal pliers
- 1 pc 6" long nose pliers
- 6 pcs screwdrivers
- 13 pcs 1/2" Dr. Socket
- 1 pc 1/2" Dr. extension bar 5"
- 1 pc 1/2" Dr. spark plug socket 21mm
- 1 pcs 1/2" Dr. Ratchet handle

ITEM NO.	SIZE		
HTS1001	68		1



**54PCS 3/8" DR. TOOL SET**

- 14pcs 3.8" Dr. Sockets 7, 8, 9, 10, 11, 12, 13, 14, 15, 16, 17, 19, 22, 24mm
- 1pcs 3.8" Dr. ratchet handle w/ quick release
- 2pcs screwdriver (-)(+) 6x100mm
- 22 pcs bolts holder
- 1pc long nose plier 6"
- 1pc water pump plier 10"
- 1pc diagonal plier 6"
- 9pcs hex key wrench: 1.5-10mm/holder
- 1pc 1/4" Dr. T handle
- 1pc 3/8" Dr. universal joint
- 1pc 1/4 Dr. coupler
- 32pcs 25L bits

ITEM NO.	SIZE		
HTS1002	54pcs		1



**28PCS TOOL SET**

- 6pcs precision screw driver
- 1 pc knife
- 1 pc long nose pliers
- 2pcs screw drivers
- 1 pc tester
- 1 pc electrical soldering iron
- 1 pc electrical tape
- 1 pc multimeter
- 1 pc wire stripper
- 1 pc solder sucker
- 1 pc fastener box
- 1 pc lin pen

ITEM NO.	SIZE		
HTS1003	28pcs		6



**42PCS TOOL SET**

- 1pc screwdriver bit holder
- 1pc voltage test
- 1pc combination plier
- 1pc 18mm cutter knife
- 1pc adjustable wrench
- 1pc 12OZ hammer
- 1pc 5mx19mm measuring tape
- 10pcs 18mm blade
- 9pcs hex key
- 10pcs 6.35mmx25mm bits
- 1pc 1/4"x60mm magnetic bits holder
- 2pcs 3x50mm precision screwdriver
- 1pc blow case

ITEM NO.	SIZE		
HTS1005	42pcs		4



**78PCS TOOL SET**

- 1pc tweezers
- 1pc scissor
- 1pc adjustable wrench
- 1pc water pump pliers
- 1pc saw
- 1pc tester
- 1c long nose plier
- 1pc combination pliers
- 1pc knife
- 1pc tape 3m
- 6pcs combination wrench
- 13pcs 1/4" Dr. sockets
- 9pcs 3/8" Dr. sockets
- 6pcs screwdrivers
- 1pc locking pliers
- 2pcs ratchet handle
- 20pcs 25L bits
- 1pc 3/8 Dr. extension bar
- 1pc 3/8 Dr. spark plug socket
- 1 pc hammer

ITEM NO.	SIZE		
HTS1006	78		4

**60PCS 3/8 DR. TOOL SET**

- 1pc adjustable wrench
- 1pc 18mm cutter knife
- 1pc diagonal plier
- 1pc combination plier
- 1pc 3mx16mm measuring tape
- 1pc 16OZ hammer
- 1pc ratchet wrench
- 1pc topedo level
- 1pc screwdriver with bit holder
- 1pc 1/4x60mm magnetic bit holder
- 32pcs 6.35x25mm bits
- 9pcs 1/4" socket

ITEM NO.	SIZE		
HTS1004	60pcs		5



HAND TOOLS

POWER TOOL ACCESSORIES

CAR TOOLS

POWER TOOLS

AIR TOOLS

GARDEN TOOLS

# Hand Tools- Hand Tool Set



## 85 PCS 1/4" DR. TOOL SET

- 14pcs 1/4 Dr. socket: 4-14mm
- 1pc 1/4" Dr. ratchet handle w/quick release
- 1pc 1/4" Dr. extension Bar 3"
- 4pcs screwdriver
- 1pc driver handle
- 40pcs bits x 25mmL W/Holder
- 6pcs combination wrench: 8-17mm
- 1pc claw hammer
- 1pc long nose pliers: 6"
- 1pc linesman plier: 6"
- 1pc diagonal plier: 6"
- 8pcs hex key wrench 1.5-6mm/Holder
- 4pcs precision screwdriver
- 1pc fastterminals W/case
- 1pc measuring tape: 5M

ITEM NO.	SIZE		
HTS1007	85pcs		4



## TOOL CABINET

- Product size: 760x160x805mm
- Rolled steel for frame and drawers
- Ball bearing drawers
- High-end alum, handle with quick lock

ITEM NO.	SIZE		
HTS1008	220pcs		4

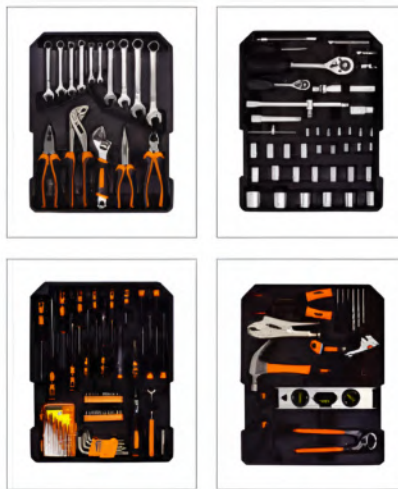

## 186PCS TOOL SET

- 9pcs combination wrench: 8-17mm
- 1pc diagonal plier
- 1pc long nose plier
- 1pc water pump plier
- 1pc adjustable wrench
- 1pc combination plier
- 13pcs 1/4" Dr. socket: 4-14mm
- 17pcs 1/2" Dr. socket: 8-30mm
- 2pcs 1/4" extension bar 2" & 4"
- 2pcs 1/2" extension bar 5" & 10"
- 1pc 1/4 sliding bar
- 2pcs 1/2" spark plug socket 16 & 21mm
- 1pc 1/4" Dr. ratchet handle
- 1pc 1/2" Dr. ratchet handle
- 2pcs universal joint 1/4" & 1/2"
- 1pc 1/4" spinner handle
- 1pc 1/4" Dr. flexible extension
- 11pcs screwdriver
- 4pcs precision screwdriver
- 4pcs telecommunication screwdriver
- 1pc tester
- 1pc magnetic bits holder
- 1pc 1/4 y-key
- 1pc magnetic pickup
- 1pc ratchet screwdriver handle
- 9pcs hex key (1.5-10mm)
- 21pcs bits
- 2pcs clam
- 3pcs masonry drill
- 3pcs wood drill
- 3pcs twist drill
- 1pc hammer
- 1pc knife
- 1pc level
- 1pc wire stripper
- 1pc electric tape
- 1pc locking pliers
- 1pc carpenter pliers
- 1pc aluminum alloy rod box

ITEM NO.	SIZE		
HTS1009	186pcs		1

## 130PCS TOOL SET

- 8pcs hex key (2, 2.5, 3, 4, 5, 6, 7, 8mm)
- 1pc 10" saw
- 1pc 16" level
- 1pc 18mm knife
- 10pcs knife blades
- 1pc 9" scissor
- 1pc 10" water pump pliers
- 2pc 8" combination pliers
- 1pc 7" heavy duty diagonal pliers
- 1pc 6" wire stripping pliers
- 6pcs combination ratchet spanner (8, 10, 11, 13, 14mm)
- 8pcs screwdriver
- 3pcs precision screwdriver
- 1pc 6" long nose pliers
- 1pc 4" mini diagonal pliers
- 15pcs 1/2" Dr. socket (10, 11, 12, 13, 14, 15, 16, 17, 18, 19, 20, 21, 22, 23, 24mm)
- 10pcs 1/4" Dr. socket (4, 5, 6, 7, 8, 9, 10, 11, 12, 13mm)
- 2pcs 1/2" Dr. spark plug socket (16, 21mm)
- 2pcs universal joint (1/2", 1/4")
- 2pcs ratchet handle (1/2", 1/4")
- 2pcs sliding bar (1/4"x100mm, 1/2"x250mm)
- 1pc extension bar 1/4" x 100mm
- 1pc flexible extension bar 150mm
- 1pc 30mm french type joiner hammer
- 1pc spinner handle
- 1pc coupler
- 60pcs 25mm bits
- 1pc 1/4"mm bits
- 1pc 1/4" quick holder

ITEM NO.	SIZE		
HTS1010	130pcs		1

HAND TOOLS

POWER TOOL ACCESSORIES

CAR TOOLS

POWER TOOLS

AIR TOOLS

GARDEN TOOLS



**BYPASS PRUNER**

- Material: SK5 blade
- Blade surface: Chrome plated
- Hand: Aluminum alloy handle with TPR grip
- Lenth: 8"
- Packed by PP card hanger

ITEM NO.	SIZE		
HTSH1000	8"(200mm)	6	8



**BYPASS PRUNER**

- Material: SK5 blade
- Upper blade surface: Non-stick coating
- Lower blade surface: Chrome plated
- Handle: Aluminum alloy handle with TPR grip
- Lenth: 8"
- Packed by PP card hanger

ITEM NO.	SIZE		
HTSH1001	8"(200mm)	6	48



**BYPASS PRUNER**

- Material: SK5 blade
- Upper blade surface: Non-stick coating
- Lower blade surface: Chrome plated
- Handle: Aluminum alloy handle with TPR grip
- Lenth: 8"
- Packed by PP card hanger

ITEM NO.	SIZE		
HTSH1002	8"(200mm)	6	48



**8" BYPASS PRUNER**

- Material: SK5 blade
- Lenth: 8"
- Hand: Aluminum alloy handle +TPR
- Packed by PP card hanger

ITEM NO.	SIZE		
HTSH1003	8"(200mm)	6	8



**PRUNING SHEARS**

- Material: stainless steel
- Upper blade surface: polish
- Lower blade surface: polish
- Handle: Zinc alloy handle with PVC coating
- Lenth: 8"
- Packed by PP card hanger

ITEM NO.	SIZE		
HTSH1004	8"(200mm)	6	48



**BYPASS PRUNER**

- Material: Carbon steel
- Upper blade surface: Non-stick coating
- Lower blade surface: Chrome plated
- Handle: Aluminum alloy handle with PVC coating
- Lenth: 8"
- Packed by PP card hanger

ITEM NO.	SIZE		
HTSH1005	8"(200mm)	6	48



**BYPASS PRUNER**

- Material: Carbon steel
- Upper blade surface: Non-stick coating
- Lower blade surface: Chrome plated
- Handle: Aluminum alloy handle with PVC coating
- Lenth: 8"
- Packed by PP card hanger

ITEM NO.	SIZE		
HTSH1006	8"(200mm)	6	48



**MULTI PURPOSE SCISSOR**

- Material: stainless steel blade
- Lenth: 7"
- Handle: PP+TPR
- Packed by PP card hanger

ITEM NO.	SIZE		
HTSH1007	8"(200mm)	6	48

HAND TOOLS

POWER TOOL ACCESSORIES

CAR TOOLS

POWER TOOLS

AIR TOOLS

GARDEN TOOLS

# Hand Tools - Shears



## PRUNING SHEARS

- Material: stainless steel blade
- Length: 6-1/4"
- Handle: Zinc alloy + TPR
- Packed by PP card hanger

ITEM NO.	SIZE		
HTSH1008	6-1/4"(160mm)	6	48



## PRUNING SHEARS

- Material: SK5 blade
- Lenth: 8"
- Nylon b
- Packed by PP card hanger

ITEM NO.	SIZE		
HTSH1009	8"(200mm)	6	48



## HEAVY DUTY PRUNING SHEARS

- Material: forged high carbon steel
- Packed by sliding card

ITEM NO.	SIZE		
HTSH1010	8" (200mm)	6	60
HTSH1011	9" (230mm)	6	48
HTSH1012	10"(250mm)	6	36



## PRUNING SHEARS

- Material: forged high carbon steel
- Handle: PVC coating
- Packed by sliding card

ITEM NO.	SIZE		
HTSH1013	8" (200mm)	6	48
HTSH1014	10" (250mm)	6	48



## PRUNING SHEARS

- Material: forged high carbon steel
- Handle: PVC coating
- Length: 8"
- Packed by sliding card

ITEM NO.	SIZE		
HTSH1015	8" (200mm)		48



## HEDGE SHEARS

- 10" way top blade
- Carbon steel TFE non-stick coating blades
- Oval steel tube handle with comfort grips
- Hand adjustable blade tension
- Cushion bumpers
- Packed by tie on card

ITEM NO.	SIZE		
HTSH1016	25-1/2" (650mm)		12



## HEDGE SHEARS

- 10" straight top blade
- Carbon steel TFE non-stick coating blades
- Oval steel tube handle with comfort grips
- Hand adjustable blade tension
- Cushion bumpers
- Packed by tie on card

ITEM NO.	SIZE		
HTSH1017	25-1/2" (650mm)		12



## TELESCOPIC HEDGE SHEAR

- Carbon steel teflon non-stick coating blade
- Aluminum telescopic tube handles with TPR +PP grips
- Packed by tie on card

ITEM NO.	SIZE		
HTSH1018	17"-34" (430-670mm)		12



## HEDGE SHEARS

- Material: stainless steel
- Upper blade surface: non-stick coating
- Lower blade surface: chrome plated
- Handle: ash wood handle
- Lenth: 21-1/4"
- Packed bytie on card

ITEM NO.	SIZE		
HTSH1019	21-3/4" (550mm)		12

HAND TOOLS

POWER TOOL ACCESSORIES

CAR TOOLS

POWER TOOLS

AIR TOOLS

GARDEN TOOLS



HAND TOOLS  
POWER TOOL ACCESSORIES  
CAR TOOLS  
POWER TOOLS  
AIR TOOLS  
GARDEN TOOLS



**BYPASS LOPPER**

- Upper blade: Carbon steel non-stick coating blade
- Lower blade: Carbon steel half luster plated blade
- Oval aluminum tube handles with comfort grip
- Packed by tie on card

ITEM NO.	SIZE		
HTSH1020	28" (710mm)		12



**ANVIL LOPPER**

- Upper blade: Carbon steel non-stick coating blade
- Lower blade: Carbon steel half luster plated blade
- Oval aluminum tube handles with comfort grip
- Packed by tie on card

ITEM NO.	SIZE		
HTSH1021	31" (790mm)		12



**BYPASS LOPPER**

- Carbon steel TFE non-stick coating blade
- Anodized oval aluminum tube handles with comfort grip
- Cushion bumpers
- Packed by tie on card

ITEM NO.	SIZE		
HTSH1022	28-1/2" (720mm)		12



**BYPASS LOPPER**

- Carbon steel TFE non-stick coating blade
- Anodized oval aluminum tube handles with comfort grip
- Cushion bumpers
- Packed by tie on card

ITEM NO.	SIZE		
HTSH1023	28-1/2" (725mm)		12



**TELESCOPIC LOPPER**

- Heavy duty bypass
- Carbon steel TFE non-stick coating blade
- Oval aluminum tube handles with comfort grip
- Packed by tie on card

ITEM NO.	SIZE		
HTSH1024	26-1/2"-36" (675-910mm)		12



**TELESCOPIC LOPPING SHEARS**

- Carbon steel teflonnon-stick coating blade
- Aluminum telescopic tube handles with TPR+PP grips
- Packed by tie on card

ITEM NO.	SIZE		
HTSH1025	26"-39" (660-990mm)		12



**TELESCOPIC LOPPING SHEARS**

- Carbon steel teflonnon-stick coating blade
- Aluminum telescopic tube handles with TPR+PP grips
- Packed by tie on card

ITEM NO.	SIZE		
HTSH1026	27"-40" (700-1020mm)*		12



**3PCS GARDEN SHEAR SET**

- 1pc 25" lopping shears 635mm
- 1pc 20" hedge shears 500mm
- 1pc 8" bypass pruning shears 200mm
- Packed by tie on card

ITEM NO.	SIZE		
HTSH1027	3pcs		12

# Hand Tools - Garden Tools



## HEDGE SHEARS

- Upper blade: Non-stick Teflon-s coated blade
- Lower blade: Sand blasted with half luster plated blade
- Painted Steel handles with vinyl grips
- Package: Sliding card

ITEM NO.	SIZE		
HTGT1000	13-1/4"(355mm)		12/60



## WAVY GRASS SHEAR

- Upper blade: Non-stick Teflon-s coated blade
- Lower blade: Sand blasted with half luster plated blade
- Plastic handles with TRP non slip grip
- Plastic safety lock
- Package: Sliding card

ITEM NO.	SIZE		
HTGT1002	13-1/2"(345mm)		24



## 3PCS GARDEN TOOLS KIT PVC BAY

- 11-1/2" Plastic trans planter
- 11-1/4" Plastic cultivator
- 10-1/4" Plastic hand fork
- Plastic fiberglass material
- Package by hang tag

ITEM NO.	SIZE		
HTGT1004	3pcs		20



## 8-PATTERN PLASTIC SPRAY GUN

- 8-pattern include: center, mist, shower, angle, full soaker, cone flat
- Package: blister card
- Material: ABS, PP, TRP

ITEM NO.	SIZE		
HTGT1007	8 funtion	12	48



## TREE POLE PRUNERS

- Material : carbon steel
- Blade surface: non-stick coating
- Blade base: steel material
- Handle: round steel pole with powder coated

ITEM NO.	SIZE		
HTGT1001	48"-96" (1.2-2.4m)		6



## TREE POLE PRUNERS

- Material : carbon steel
- Blade surface: non-stick coating
- Blade base: steel material
- Handle: round steel pole with powder coated
- With 13" saw blade
- Length:48"-96" (1.2-2.4m)
- Packed by hang tag

ITEM NO.	SIZE		
HTGT1003	48"-96" (1.2-2.4m)		6



## 3PCS GARDEN TOOLS KIT

- Material all body with carbon steel
- Packed by PVC bag

ITEM NO.	SIZE		
HTGT1005	3pcs		20



## ADJUSTABLE METAL SPRAY GUN

- Adjustable spray from off, fine mist to powerful jet stream
- Package: blister card
- Material: ABS, PP, TRP, Zinc alloy, brass

ITEM NO.	SIZE		
HTGT1008	2 funtion	12	48



## ADJUSTABLE PLASTIC SPRAY GUN

- Adjustable spray from off, fine mist to powerful jet stream
- Material ABS, PP, TRP
- Package: Blister card

ITEM NO.	SIZE		
HTGT1006	2 function	12	48



## 8-PATTERN METAL SPRAY GUN

- Package: blister card
- Material: ABS, PP, TRP, Zinc alloy

ITEM NO.	SIZE		
HTGT1009	8 funtion	12	48



**4PCS ADJUSTABLE PLASTIC SPRAY GUN SET**

- Adjustable spray from off fine mist to powerful jet stream
- And the set include 1/2" hose connector, 1/2 waterstop hose connector 1/2 & 3/4" tap adaptor
- Package: blister card
- Material: ABS, PP, TRP

ITEM NO.	SIZE		
HTGT1010	4pcs	12	48



**8-PATTERN PLASTIC SPRAY GUN AND HOSE FITTINGS**

- 8-pattern include: center. mist, shower, angle, full soaker, cone flat
- And the set include 1/2" hose connector, 1/2 waterstop hose connector 1/2 & 3/4" tap adaptor
- Package: blister card
- Material: ABS, PP, TRP

ITEM NO.	SIZE		
HTGT1011	4pcs	12	48



**PLASTIC IMPULSE SPRINKLER WITH SPIKE**

- Material: POM, ABS
- Package: tie on card

ITEM NO.	SIZE		
HTGT1012	11"	12	48



**METAL IMPULSE SPRINKLER WITH ZINC SPIKE**

- Material: Brass, zinc alloy
- Package: tie on card

ITEM NO.	SIZE		
HTGT1014	11"	12	48



**HOSE BASIC SET FOR 1/2" HOSE**

- Include 1/2" hose connector, 1/2" waterstop hose connector 1/2" & 3/4" tap adaptor, adjustable hose nozzle
- Material: ABS, PP
- Package: blister card

ITEM NO.	SIZE		
HTGT1013	4pcs	12	48



**FLOWER BASE 8-PATTERN SPRINKLER**

- Material: PP, ABS
- Package: color box

ITEM NO.	SIZE		
HTGT1015	8pcs	12	48



**PLASTIC IMPULSE SPRINKLER WITH BUTTERFLY BASE**

- Material: PP, ABS
- Package: color box

ITEM NO.	SIZE		
HTGT1017	12	12	48



**PORTABLE HOSE CART WITHOUT HOSE**

- Handle adjustable
- Store up to 45m(1/2" or 13mm) hose
- Easy assembly without tools
- Package: color box
- Material: PP, steel, ABS

ITEM NO.	SIZE		
HTGT1016	60m		6



**PORTABLE HOSE CART WITHOUT HOSE**

- Handle adjustable
- Store up to 45m(1/2" or 13mm) hose
- Easy assembly without tools
- Material: PP, steel, ABS

ITEM NO.	SIZE		
HTGT1018	45m		5

HAND TOOLS

POWER TOOL ACCESSORIES

CAR TOOLS

POWER TOOLS

AIR TOOLS

GARDEN TOOLS



## WHEEL BARROW

- Capacity: 130kg water capacity 65L
- Thickness: 0.5mm
- Material: Galvanized sheet
- Wheel: 16"x4.00-6



ITEM NO.	SIZE		
HTGT1019	1290x665x545mm		1

## WHEEL BARROW

- Capacity: 200kg water capacity 90L
- Thickness: 07mm
- Material: Galvanized sheet
- Wheel: 16"x4.00-8



ITEM NO.	SIZE		
HTGT1020	1400x650x640mm		1

## GARDEN TOOL CART

- Capacit: 100kg
- Wheel : 8"x1.75"



ITEM NO.	SIZE		
HTGT1021	980x535x1130mm		1

## GARDEN TOOL CART

- Capacit: 300kg
- Wheel : 10"x3.50-4"



ITEM NO.	SIZE		
HTGT1022	1865x520x570mm		1



## 14 TEETH RAKE

- Material : A3 steel
- Thickness: 2.6mm
- package: color cabel

ITEM NO.	SIZE		
HTGT1023	14T		10



## 22 TEETH RAKE

- Material : 70W steel
- Weight: 600g
- 42-45HRC
- Package: Color cabel

ITEM NO.	SIZE		
HTGT1024	22T		40



## 15M COIL HOSE SET EVA

- Material : ABS, PP,EVA
- Package: Double blister

ITEM NO.	SIZE		
HTGT1025	15m		10



## 1/2 15m GARDEN HOSE SET

- Material : PVC, PP, ABS
- Package: Shrink

ITEM NO.	SIZE		
HTGT1026	1/2" 15m		10



## MAGIC HOSE

- Latex tube (with double layers) / expands up to 3times its original lenght, automaticly contacts when is turn off
- Packade: color box

ITEM NO.	SIZE		
HTGT1027	25T		12
HTGT1028	50T		12
HTGT1029	75T		12
HTGT1030	100T		12





### GARDEN KNIFE

- Material: 2CR13
- PP handle
- Thickness: 1.2mm

ITEM NO.	SIZE		
HTGT1031	6"		100



### SUGAR CANE KNIFE

- Material: 65Mn
- PP handle with TRp grip
- Thickness: 2.9mm

ITEM NO.	SIZE		
HTGT1032	12"		36



### SUGAR CANE KNIFE

- Material: 65Mn
- PP handle
- Thickness: 2.0mm

ITEM NO.	SIZE		
HTGT1033	16"		36
HTGT1034	18"		36
HTGT1035	20"		36
HTGT1036	22"		36



### SUGAR CANE KNIFE

- Material: 65Mn
- PP handle
- Thickness: 2.0mm

ITEM NO.	SIZE		
HTGT1037	16"		36
HTGT1038	18"		36
HTGT1039	20"		36
HTGT1040	22"		36

### PORTABLE GAS STOVE/CASSETTE STOVE

- Gas consumption: 155g/h
- Gas type: BDP-250A
- Ignite way: Electrical Ignition
- Body material: Cold roll sheet
- Packed by plastic case/color box



ITEM NO.	SIZE		
HTGT1041	155g/h		6

### WATER HOSE REEL

- Hose length: 10-1M
- Hose material: PVC
- Case material: PP
- Working pressure: 10 bar
- Hose size: 5/16"
- Fitting: 3/4"
- Packed by color ox



ITEM NO.	SIZE		
HTGT1042	155g/h		1

### WATER HOSE REEL

- Hose length: 10+1M, 1M+1.5M
- 20+2M, 25+2M, 30+2M
- Hose material: PVC
- Case material: PP
- Working pressure: 10 bar
- Hose size: 5/16", 1/2"
- Fitting: 3/4"
- Packed by color box



ITEM NO.	SIZE		
HTGT1043	10+1M		1
HTGT1044	15+1.5M		1
HTGT1045	20+2M		1
HTGT1046	25+2M		1
HTGT1047	30+2M		1





### SHOVEL HEAD

- Material: Iron
- Weight 0.75±0.05kg
- Black painted
- Packed by color sticker

ITEM NO.	SIZE		
HTSV1000	220x350mm		12

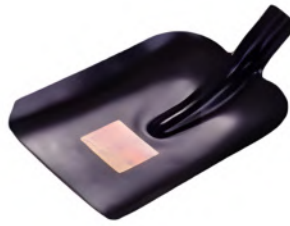

### SHOVEL HEAD

- Material: Iron
- Weight 0.75±0.05kg
- Black painted
- Packed by color sticker

ITEM NO.	SIZE		
HTSV1001	235x400mm		12



### SHOVEL HEAD

- Material: Iron
- Weight 0.75±0.05kg
- Black painted
- Packed by color sticker

ITEM NO.	SIZE		
HTSV1002	210x500mm		12



### SHOVEL HEAD

- Material: Iron
- Weight 0.75±0.05kg
- Black painted
- Packed by color sticker

ITEM NO.	SIZE		
HTSV1003	210x400mm		12



### SHOVEL HEAD

- Material: Iron
- Weight 0.75±0.05kg
- Black painted
- Packed by color sticker

ITEM NO.	SIZE		
HTSV1004	230x320mm		12



### PICKAXE

- Free forging
- Material: rail steel
- Packed by color sticker

ITEM NO.	SIZE		
HTSV1005	1.5kg		12
HTSV1006	2kg		12
HTSV1007	2.5kg		12
HTSV1008	3kg		12



### SHOVEL

- Iron head with heat treatment
- Fiberglass handle with plastic Y handle
- Total length: 1050± 10mm
- Packed by color sticker

ITEM NO.	SIZE		
HTSV1009	220x1050mm		12

### SHOVEL

- Iron head with heat treatment
- F/Wooden handle
- Total length: 1050± 10mm
- Packed by color sticker

ITEM NO.	SIZE		
HTSV1010	220x1500mm		12



### SHOVEL

- Iron head with heat treatment
- Fiberglass handle with plastic Y handle
- Total length: 1650± 10mm
- Packed by color sticker

ITEM NO.	SIZE		
HTSV1011	270x1650mm		12

HAND TOOLS

POWER TOOL ACCESSORIES

CAR TOOLS

POWER TOOLS

AIR TOOLS

GARDEN TOOLS



Tel: 505-550-6501  
Fax: 505-814-5778  
Email: sales@agstech.net  
Web: www.agstech.net

# PRIVATE LABEL OPTION

## OEM OPTION

**We can put your company name, brand....on these**

