

Vision for Imagination

MACHINE VISION SMART PRODUCT CATALOG



AGS-TECH Inc.

Phone: +1-505-550-6501 and +1-505-565-5102

Fax: +1-505-814-5778

Email: sales@agstech.net

Web: <http://www.agstech.net>







**Let us customize machine vision platforms to your needs
Contact us for brand new, refurbished or used Equipment**

HIKROBOT

Overview

<p>SC2000E Series Vision Sensor P10</p>  <ul style="list-style-type: none"> Resolution range 0.4MP-1.6MP It has existence, position, defect, logic, count, measurement and recognition vision tools 	<p>SC3000 Series Vision Sensor P14</p>  <ul style="list-style-type: none"> Resolution range 1.6MP-5MP It has existence, position, defect, logic, count, measurement and recognition vision tools 	<p>SC5000 Series Smart Camera P18</p>  <ul style="list-style-type: none"> Resolution range 1.6MP-20MP It has existence, position, defect, logic, count, measurement and recognition vision tools
<p>SC7000P Series Smart Camera P22</p>  <ul style="list-style-type: none"> Resolution range 1.6MP-20MP It has existence, position, defect, logic, count, measurement, recognition and deep learning vision tools 	<p>ID2000 Series Smart Code Reader P32</p>  <ul style="list-style-type: none"> Extremely small fixed industrial code reader, which can be embedded in automated machine equipment Suitable for lithium, packaging, consumer electronics and other industries 	<p>ID3000 Series Smart Code Reader P36</p>  <ul style="list-style-type: none"> Compact fixed industrial code reader, high speed reading, high reading rate Suitable for lithium, consumer electronics, photovoltaic, panel, auto parts, tobacco and other industries
<p>ID5000 Series Smart Code Reader P38</p>  <ul style="list-style-type: none"> Full-featured fixed industrial code reader, large FOV Suitable for PCB, automotive, manufacturing, internal logistics, food and drug industries 	<p>ID6000 Series Smart Code Reader P42</p>  <ul style="list-style-type: none"> Logistics industry special type high-resolution code reader Responding to complex logistics code reading application scenarios 	<p>ID7000 Series Smart Code Reader P44</p>  <ul style="list-style-type: none"> Logistics industry special type smart line scan code reader Easily covers conveyor belts up to 1.4m wide
<p>PD Series Integration Code Reader P46</p>  <ul style="list-style-type: none"> Core component products for code reading devices, standard and smart models available Integrates image acquisition, data processing and result output functions 	<p>IDH Series Handheld Smart Code Reader P48</p>  <ul style="list-style-type: none"> The handheld scanner with excellent user experience Applicable to PCB, 3C, auto parts, lithium, home appliance manufacturing and other industries 	<p>Line Laser 3D Camera P54</p>  <ul style="list-style-type: none"> Accurate measurement and output of dimensional information of target objects Suitable for express parcel dynamic 3D measurement application scenarios

Contact us for brand new, refurbished or used Equipment

<p>RGB-D Smart 3D Camera P56</p>  <ul style="list-style-type: none"> Outputs RGBSDepth images at high frame rates Used for volume measurement, EDP, singulation system and robotic parcel-feeding system 	<p>VB2000 Series Vision Controller P60</p>  <ul style="list-style-type: none"> Central processing equipment for integrated machine vision control and processing Compact design, it supports a full range of machine vision system control and data transmission interfaces 	<p>VC2000 Series Vision Controller P62</p>  <ul style="list-style-type: none"> Equipped with Intel high-performance CPU, equipped with rich data acquisition and control interface Compact in design, it provides a complete solution for multi-camera simple vision applications
<p>VC3000 Series Vision Controller P64</p>  <ul style="list-style-type: none"> Devices for control and processing of vision inspection with strong arithmetic power, as well as rich data acquisition and control interfaces Good compatibility of machine vision components in positioning, inspection, measurement, identification and other tasks 	<p>VM Algorithm Development Platform P66</p>  <ul style="list-style-type: none"> Self-developed machine vision software with 140+ modules and tools Applications in machine vision applications such as visual positioning, dimensional measurement, defect detection, and information recognition 	<p>CodePlatform P72</p>  <ul style="list-style-type: none"> Comprehensive code reading software platform, including data acquisition, image processing, communication output, data statistics and other functions Suitable for flexible code reading needs of various complex scenarios in logistics enterprises

CONTENTS

Overview	2	ID7000 Series Smart Code Reader	44
Machine Vision System	5	PD Series Logistics Code Reader	46
Performance and Application of Smart Camera	6	IDH Series Handheld Smart Code Reader	48
Smart Camera	10	IDMVS Client	51
SC2000E Series Vision Sensor	10	Performance and Application of 3D Camera	52
SC3000 Series Vision Sensor	14	3D Camera	54
SC5000 Series Smart Camera	18	Line Laser 3D Camera	54
SC7000Pro Series Smart Camera	22	RGB-D smart 3D camera	56
SCMVS client	26	3DMVS Client	58
Performance and Application of Smart Code Reader	27	Vision Controller	56
Smart Code Reader	32	VB2000 Series Vision Controller	60
ID2000 Series Smart Code Reader	32	VC2000 Series Vision Controller	62
ID3000 Series Smart Code Reader	36	VC3000 Series Vision Controller	64
ID5000 Series Smart Code Reader	38	VM Algorithm development platform	66
ID6000 Series Smart Code Reader	42	CodePlatform	72
		Appendix	73

Let us customize machine vision platforms to your needs



Contact us for brand new, refurbished or used Equipment

Hangzhou Hikrobot Co., Ltd.

Hikrobot is a global product and solution supplier specialized in machine vision and mobile robot. Focusing on IIoT, smart logistics and smart manufacturing, we build open cooperation ecosystem, provide service to industry and logistics customers, and commit to continuously promoting the intelligentization and leading the intelligent manufacturing process.

Machine Vision

With efforts in industrial vision sensing application and hardware technology, the company provides customers with leading machine vision products. The products cover industrial camera, lens, vision box, industrial smart camera and related accessory. Through rigorous EMC, safety and reliability tests, Hikrobot guarantees the high precision, high efficiency and high environmental performance of each product. The machine vision products are widely used in industrial automation sectors such as consumer electronics, semiconductors and logistics, as a part of the vision applications like positioning guidance, measurement, quality inspection, code reading, OCR, etc. They help users to greatly improve productivity, accuracy and stability.



AGS-TECH Inc.
Phone: +1-505-550-6501 and +1-505-565-5102
Fax: +1-505-814-5778
Email: sales@agstech.net
Web: <http://www.agstech.net>

Let us customize machine vision platforms to your needs

Performance and Application of Smart Camera

Product Background

Industrial vision is widely used in food & beverage, cosmetics, pharmaceutical, building materials and chemicals, metal processing, electronics manufacturing, packaging, automotive manufacturing and other industries, and is still dominated by PC solutions. However, embedded (smart camera, X86 open platform) solutions for automated factories, the solution is simple to operate and easy to maintain equipment, and is increasingly becoming the mainstream choice.

Smart camera is a highly integrated micro and small machine vision system that integrates image acquisition, storage, processing and communication functions into one, thus forming a multi-functional, modular, highly reliable and easy-to-operate machine vision solution. At the same time, due to the continuous iterative update of DSP, FPGA and a large number of storage technologies, its intelligence has been increasing to meet the needs of increasingly complex machine vision applications.

Key Features

- Resolution range 0.4MP~20MP, Support long-range and large FOV detection
- Built-in large-capacity storage space, support for cyclic saving pictures
- Includes traditional vision algorithms as well as AI deep learning, covering all types of detection
- Support a variety of industrial communication protocols
- IP65 or higher protection level, adapt to the harsh industrial application environment

Performance

- Rich algorithms function, 30+ detection tools.

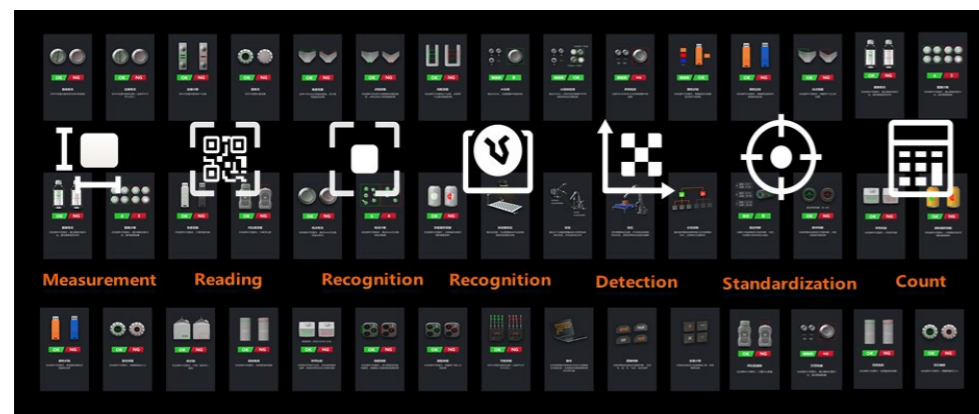

- Powerful computing platform to help more complex applications.

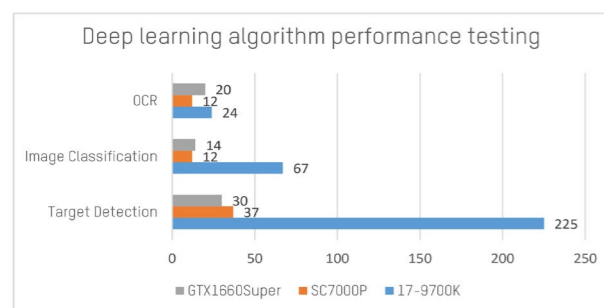

- One-button debugging parameters, automatic setting of brightness focus and white balance



Algorithm Tools

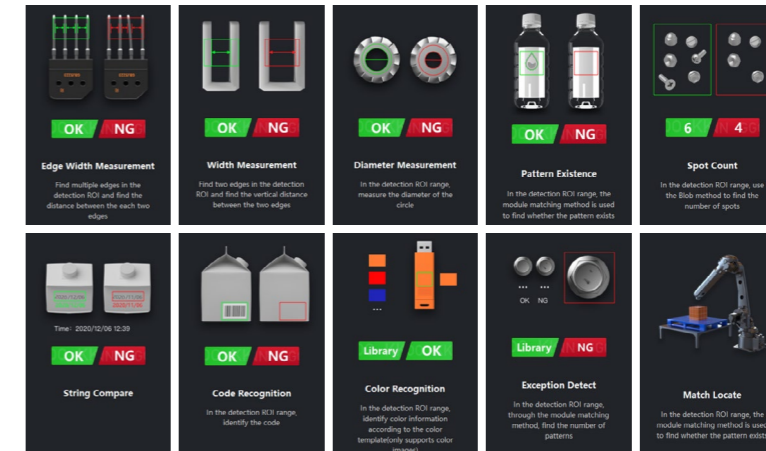

Industry Cases

Automotive & Auto Parts Industry



Error-proof detection of multi-model car wheels

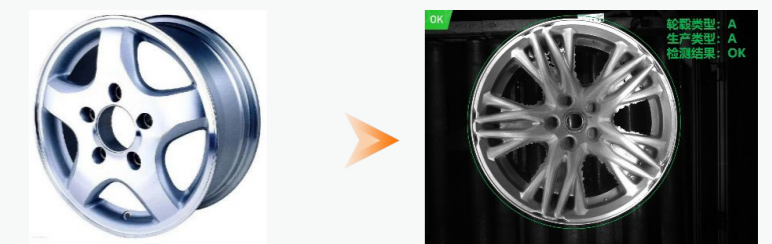

On the complete vehicle assembly line, the SC camera can judge more than 1 hundred types of wheel categories and support instant update and modification of the set wheel type information.

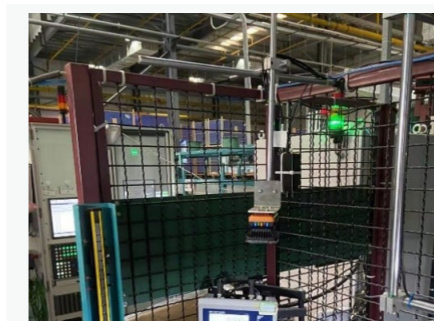

Automotive base low contrast character recognition

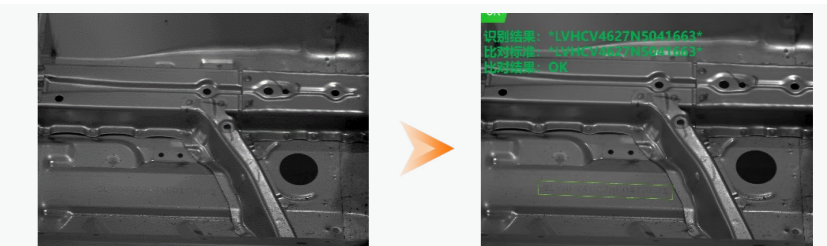

The car base carries production information, and the different materials and brightness of different models lead to shallow etched character information, in which case the AI method is used for fast recognition reading and judgment of the detection results.

Medical Industry



Pill box code traceability

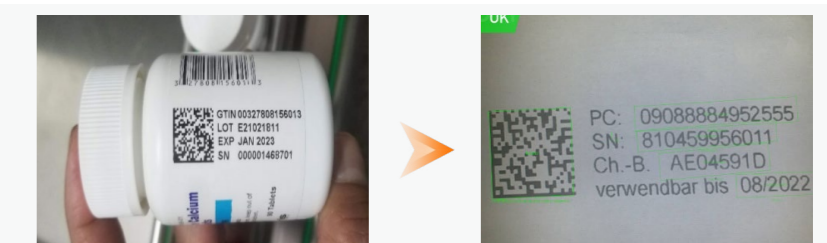

By using the AI method of OCR + code reading, up to more than 99.9% accuracy, it provides a more reliable and integrated solution for reading and identifying multiple information on the outer packaging of pharmaceutical boxes.

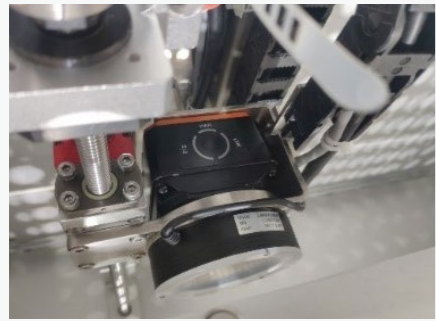

Medical culture test tube status tracking

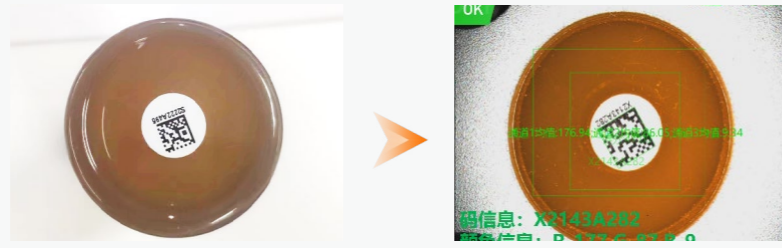

Bacteria ferment in the culture medium over time, showing different color changes in the test tube. The SC camera's ultra-high color reproduction can record the state changes of the culture medium in real time.

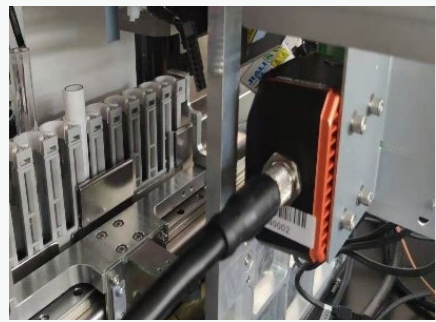

Pharmaceutical test tube multi-class judgment



Arbitrary size, shape, label interference, blood color, etc. of the test tube does not affect the full autochemical detection of drug liquid test tube, the integrated camera can realize the sample container code identification, test tube category judgment, liquid level detection, etc.

Lithium Industry



Lithium battery color detection

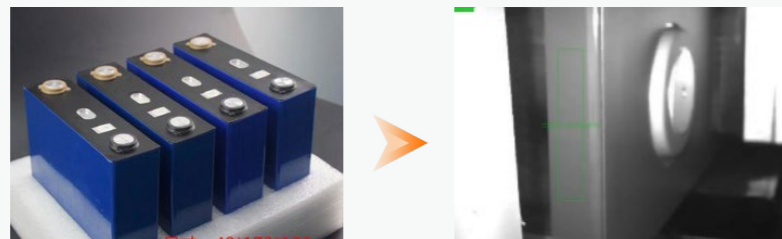

Compact models with efficient algorithms, 40ms can complete a test, 99.99% accuracy can ensure the accuracy of anti-error verification, integrated equipment installation, debugging, maintenance more convenient.

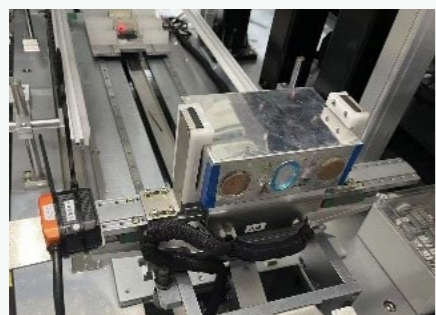

Inkjet interference in lithium battery information detection

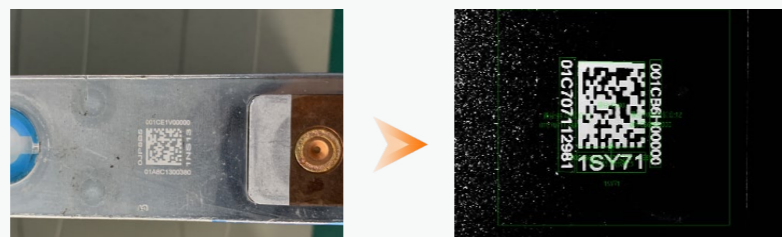

Due to inkjet and other process interference resulting in more white dot interference with characters and codes, the use of AI method of OCR + code reading, can achieve up to 99.9% accuracy rate, effectively eliminate the leakage of spray, multiple spray, spray error, missing and other abnormal products.

Packaging Industry

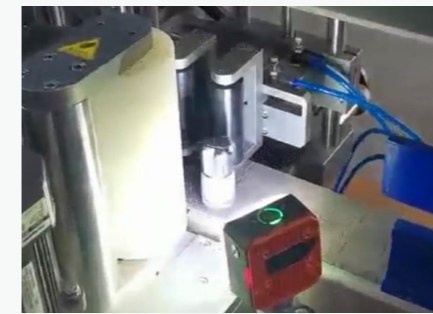

Package labeling guide ultra-high speed inspection

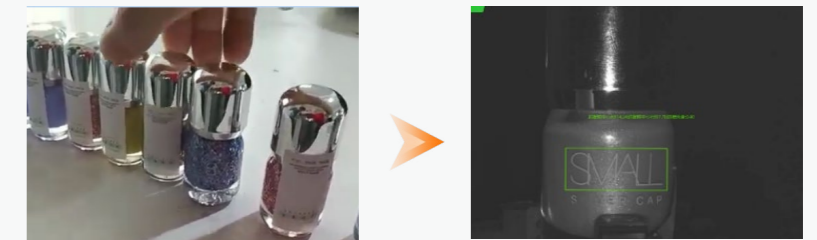

The labeling machine applies labels to bottles rotating at high speed, and the SC camera enables a full-flow high-speed inspection application from trigger to IO output, taking less than 40ms.

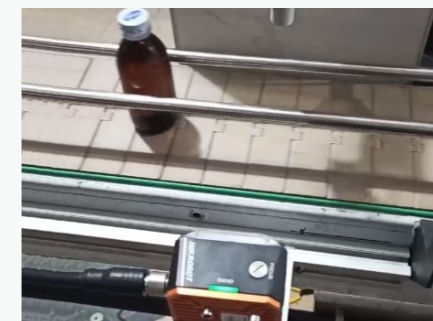

Multi-category liquid level detection



SC camera is compatible with a variety of product types and adaptive detection of a variety of liquid level heights, effectively avoiding air bubbles, impurities, etc. on the accuracy of liquid level detection.



Dynamic tracking and counting during pill packaging

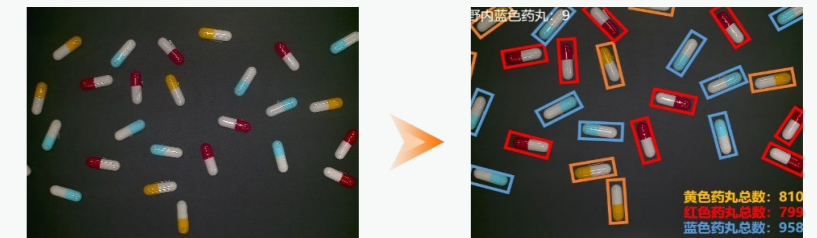

Under the high-speed application scenario, it accurately captures the information such as posture and shape of the real-time movement of materials, combines with AI algorithm, real-time analysis and processing, accurately calculates the number of materials, realizes real-time counting function, without fear of stacking and other problems, and foreign objects are automatically ignored.

Robotic arm gripping scene



Robotic arm guided product gripping



The robotic arm requires a small product size, easy installation, self-contained camera, light source, and processing algorithm, and the SC camera is compatible with a variety of product positioning gripping applications.

Smart Camera

SC2000E Series Vision Sensor

SC2000E Series Vision Sensor integrates full functions of a vision system: lighting, acquisition, processing, and communication in minimal fuselage. Bring new choices for Y/N, P/N verifications with excellent performance in error-proofing detection scenarios.

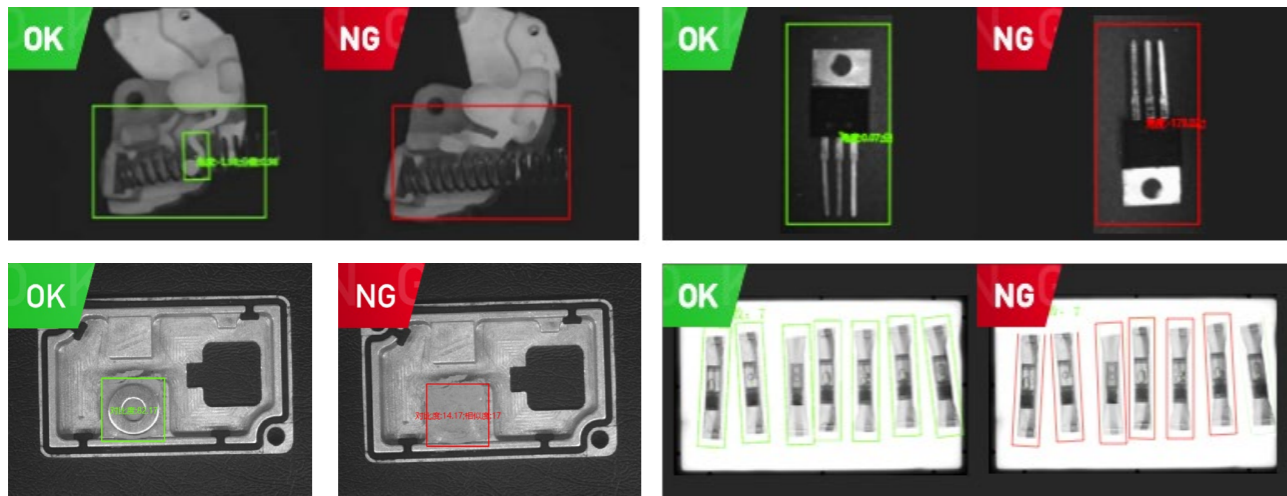

• Comprehensive Error-proofing Detection Algorithm



• Ultra-compact size

Let us customize machine vision platforms to your needs

Specifications



Model	Vision tool	Pixel size	Sensor size	Resolution	Max. frame rate	Mono/color	Focal length	Label
MV-SC2004EM(Mini)	Defect: OL classification Whether or not: circles, lines, spots, edges, patterns Positioning: Position correction Logic: condition judgment, logic judgment, character comparison, variable calculation Measurement: line Angle, diameter measurement, brightness mean, contrast measurement, width measurement, point line measurement, gray area, straight line Angle, pitch detection Recognition: Character recognition	6.9 μm	1/2.9"	704 × 540	60 fps	Mono	6.72 mm	A
MV-SC2016EM(Mini)	Defect: OL classification Whether or not: circles, lines, spots, edges, patterns Positioning: Position correction Logic: condition judgment, logic judgment, character comparison, variable calculation Measurement: line Angle, diameter measurement, brightness mean, contrast measurement, width measurement, point line measurement, gray area, straight line Angle, pitch detection Recognition: Character recognition	3.45 μm	1/2.9"	1408 × 1024	60 fps	Mono	6.72 mm	A
MV-SC2004EM	Defect: OL classification Whether or not: circles, lines, spots, edges, patterns Positioning: Position correction Logic: condition judgment, logic judgment, character comparison, variable calculation Measurement: line Angle, diameter measurement, brightness mean, contrast measurement, width measurement, point line measurement, gray area, straight line Angle, pitch detection Recognition: Character recognition	6.9 μm	1/2.9"	704 × 540	60 fps	Mono	8/12.4/14.8mm	B
MV-SC2004EC	Count: spot count, edge count, pattern count Defect: OL classification Whether or not: circles, lines, spots, edges, patterns Positioning: Position correction Logic: condition judgment, logic judgment, character comparison, variable calculation Measurement: line Angle, diameter measurement, brightness mean, contrast measurement, width measurement, point and line measurement, gray area, straight line Angle, pitch detection, color area Recognition: character recognition, color comparison	6.9 μm	1/2.9"	704 × 540	60 fps	Color	8/12.4/14.8mm	B

Contact us for brand new, refurbished or used Equipment

Model	Vision tool	Pixel size	Sensor size	Resolution	Max. frame rate	Mono/color	Focal length	Label
MV-SC2016EM	Defect: OL classification Whether or not: circles, lines, spots, edges, patterns Positioning: Position correction Logic: condition judgment, logic judgment, character comparison, variable calculation Measurement: line Angle, diameter measurement, brightness mean, contrast measurement, width measurement, point line measurement, gray area, straight line Angle, pitch detection Recognition: Character recognition	3.45 μm	1/2.9"	1408 × 1024	60 fps	Mono	8/12.4/14.8mm	B
MV-SC2016EC	Count: spot count, edge count, pattern count Defect: OL classification Whether or not: circles, lines, spots, edges, patterns Positioning: Position correction Logic: condition judgment, logic judgment, character comparison, variable calculation Measurement: line Angle, diameter measurement, brightness mean, contrast measurement, width measurement, point and line measurement, gray area, straight line Angle, pitch detection, color area Recognition: character recognition, color comparison	3.45 μm	1/2.9"	1408 × 1024	60 fps	Color	8/12.4/14.8mm	B

Dimension

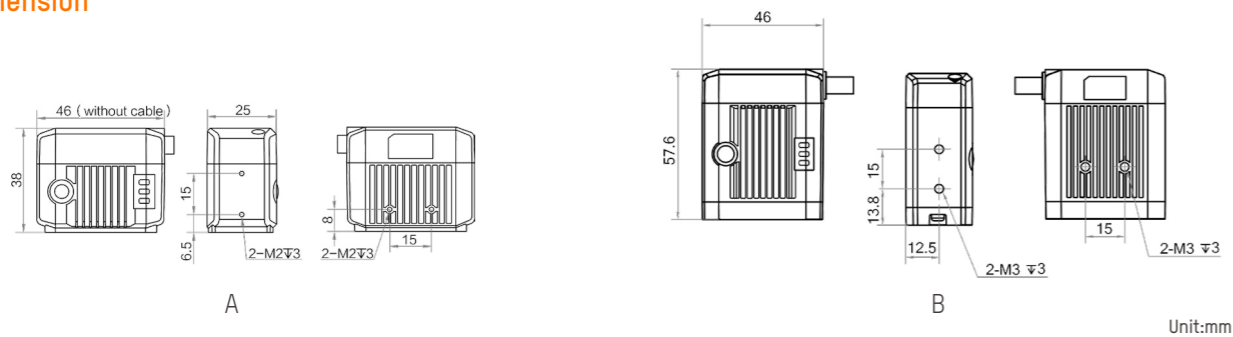

Accessories



I/O Power Cables	Standard	High Softness	Elbow
3m	MV-IDA-PE-M12A17pF-opensRJ45DB9-ST-3m	MV-IDA-PE-M12A17pF-opensRJ45DB9-HF-3m	MV-ACPE-M12A17F(back)-OPEN/RJ45-FL-3m
5m	MV-IDA-PE-M12A17pF-opensRJ45DB9-ST-5m	---	---
10m	MV-IDA-PE-M12A17pF-opensRJ45DB9-ST-10m	---	---

Let us customize machine vision platforms to your needs

I/O Power Cables	Standard	High Softness	Elbow
1m	MV-ACG-RJ45s-RJ45-ST-1m	---	---
3m	MV-ACG-RJ45s-RJ45-ST-3m	MV-ACG-RJ45s-RJ45-HF-3m	MV-ACG-RJ45s(up)-RJ45-ST-3m
5m	MV-ACG-RJ45s-RJ45-ST-5m	MV-ACG-RJ45s-RJ45-HF-5m	MV-ACG-RJ45s(up)-RJ45-ST-5m
7m	MV-ACG-RJ45s-RJ45-ST-7m	MV-ACG-RJ45s-RJ45-HF-7m	---
10m	MV-ACG-RJ45s-RJ45-ST-10m	MV-ACG-RJ45s-RJ45-HF-10m	---
15m	MV-ACG-RJ45s-RJ45-ST-15m	MV-ACG-RJ45s-RJ45-HF-15m	MV-ACG-RJ45s(up)-RJ45-ST-15m
30m	MV-ACG-RJ45s-RJ45-ST-30m	MV-ACG-RJ45s-RJ45-HF-30m	---

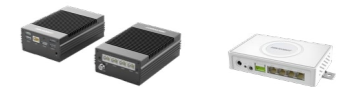

Power Supply	Power Adapter	Switching Power Supply
Model	MSA-C1500IC12.0-18P-CN	LRS-150F-24

Display Equipment	Model
Expansion Box	MV-SV100
	MV-SV400
Touch Screen	MV-VT1010-008G50



Mounting Component	Model
Standard	SC2000E Mounting Plate

Contact us for brand new, refurbished or used Equipment

SC3000 Series Vision Sensor

Integrated with imaging, processing and communication functions, the SC3000 series has a more compact size and the vision detection tools lead to better performance. Equipped with a new SCMVS for on-site deployment and lower debugging requirements, bringing a more comprehensive and cost-effective choice for visual inspection!



• Comprehensive Error-proofing Detection Algorithm

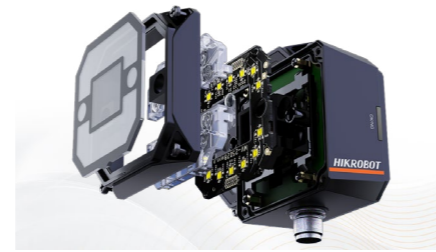

• The lens, light source, protection cover and other components can be arranged arbitrarily

Specifications



Model	Vision tool	Pixel size	Sensor size	Resolution	Max. frame rate	Mono/color	Focal length
MV-SC3016M	Count: Pattern count, spot count, edge count Defect detection: Exception detection Existence: Pattern existence, spot existence, edge existence, circle existence, line existence Location: Match location, match calibration, fixture Logic tool: If module, condition judge, logic judge, combination judge, string comparison, calculator Measurement: L2L angle, diameter measurement, brightness analysis, contrast measurement, width measurement, P2L measurement, greyscale size, line angle, edge width measurement Recognition: OCR, code recognition	3.45 μm	1/2.9"	1408 × 1024	60 fps	Mono	6/12.4/14.8 mm
MV-SC3016C	Count: Pattern count, spot count, edge count Defect detection: Exception detection Existence: Pattern existence, spot existence, edge existence, circle existence, line existence Location: Match location, match calibration, fixture Logic tool: If module, condition judge, logic judge, combination judge, string comparison, calculator Measurement: Color size, L2L angle, diameter measurement, brightness analysis, contrast measurement, width measurement, P2L measurement, greyscale size, line angle, edge width measurement Recognition: OCR, color contrast, code recognition, color recognition	3.45 μm	1/2.9"	1408 × 1024	60 fps	Color	6/12.4/14.8 mm
MV-SC3050M	Count: Pattern count, spot count, edge count Defect detection: Exception detection Existence: Pattern existence, spot existence, edge existence, circle existence, line existence Location: Match location, match calibration, fixture Logic tool: If module, condition judge, logic judge, combination judge, string comparison, calculator Measurement: L2L angle, diameter measurement, brightness analysis, contrast measurement, width measurement, P2L measurement, greyscale size, line angle, edge width measurement Recognition: OCR, code recognition	3.2 μm	1/1.7"	2368 × 1760	30 fps	Mono	8/12.4/16 mm

Dimension

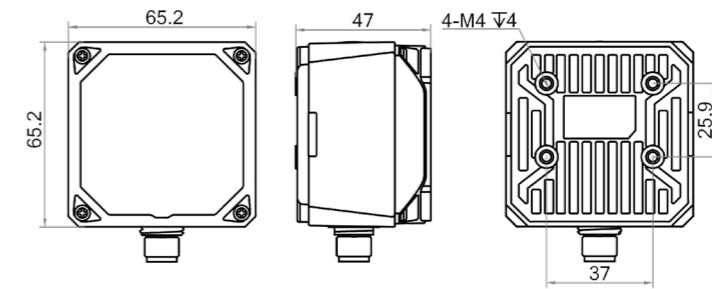

Unit:mm



I/O Power Cables	Standard	High Softness	Elbow
3m	MV-IDA-PE-M12A17pF-opensRJ45DB9-ST-3m	MV-IDA-PE-M12A17pF-opensRJ45DB9-HF-3m	MV-ACPE-M12A17F(back)-OPEN/RJ45-FL-3m
5m	MV-IDA-PE-M12A17pF-opensRJ45DB9-ST-5m	--	--
10m	MV-IDA-PE-M12A17pF-opensRJ45DB9-ST-10m	--	--



Gigabit Network Cable	Standard	High Softness	Elbow
1m	MV-ACG-RJ45s-RJ45-ST-1m	--	--
3m	MV-ACG-RJ45s-RJ45-ST-3m	MV-ACG-RJ45s-RJ45-HF-3m	MV-ACG-RJ45s(up)-RJ45-ST-3m
5m	MV-ACG-RJ45s-RJ45-ST-5m	MV-ACG-RJ45s-RJ45-HF-5m	MV-ACG-RJ45s(up)-RJ45-ST-5m
7m	MV-ACG-RJ45s-RJ45-ST-7m	MV-ACG-RJ45s-RJ45-HF-7m	--
10m	MV-ACG-RJ45s-RJ45-ST-10m	MV-ACG-RJ45s-RJ45-HF-10m	--
15m	MV-ACG-RJ45s-RJ45-ST-15m	MV-ACG-RJ45s-RJ45-HF-15m	MV-ACG-RJ45s(up)-RJ45-ST-15m
30m	MV-ACG-RJ45s-RJ45-ST-30m	MV-ACG-RJ45s-RJ45-HF-30m	--



Power Supply	Power Adapter	Switching Power Supply
Model	MSA-C1500IC12.0-18P-CN	LRS-150F-24



Lens	SC3013	SC3050
6mm	BTY0640-MP	---
8mm	---	BHYB0856-12S
12mm	BTS1240-MP	BHP1256-12S
15mm	BTS1540-01S	---
16mm	---	BHP1656-12S

Contact us for brand new, refurbished or used Equipment



Lens Cap	Model
Transparent	MV-SC3000-C-NN
Semi-polarization	MV-SC3000-C-HP
Polarization	MV-SC3000-C-FP



Display Equipment	Model
Expansion Box	MV-SV100
	MV-SV400
Touch Screen	MV-VT1010-008G50



AGS-TECH Inc.
 Phone: +1-505-550-6501 and +1-505-565-5102
 Fax: +1-505-814-5778
 Email: sales@agstech.net
 Web: http://www.agstech.net

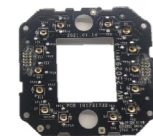

Light source	Model
White	MV-SC3000-L-WB
Blue	MV-SC3000-L-BB
Red	MV-SC3000-L-RB
Near-infrared	MV-SC3000-L-IB



Mounting Component	Model
Standard	V020-Mounting Component

Let us customize machine vision platforms to your needs

SC5000 Series Smart Camera

SC5000 Series Smart Camera has maintaining a high degree of hardware integration, algorithms such as positioning, measurement, calibration conversion, logic control, defect detection, OCR and code reading are integrated internally. Combined with the simple and easy-to-use SCMVS, it can fully cover the application scenarios of conventional visual inspection.

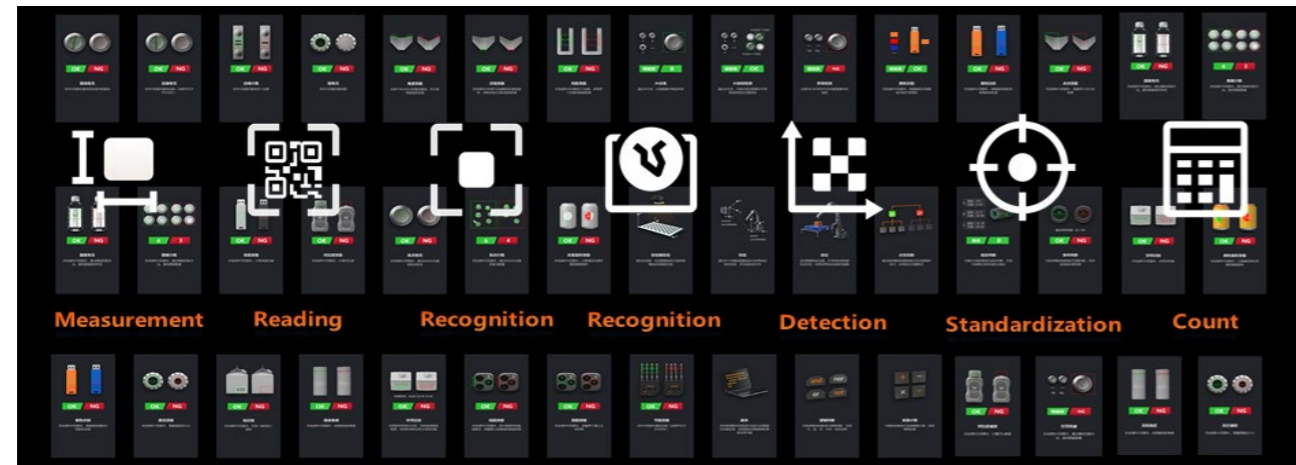

- More complete visual detection algorithm, a device can complete a variety of complex visual detection tasks

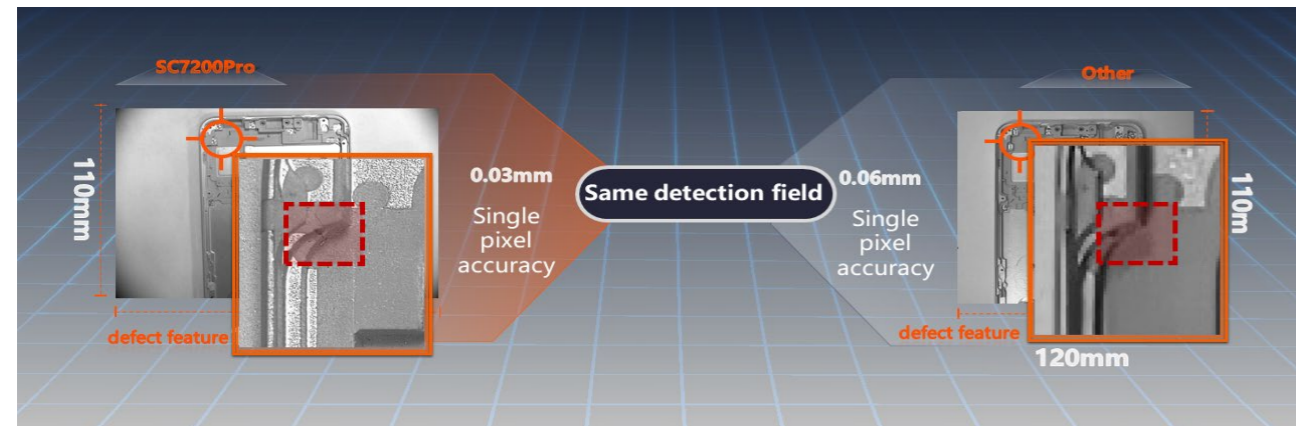

- Ultra-high precision and ultra-large visual field coverage

Specifications



Model	Vision tool	Pixel size	Sensor size	Resolution	Max. frame rate	Mono/color	Focal length	Label
MV-SC5016M	Count: Pattern count, spot count, edge count Defect detection: Exception detection Existence: Pattern existence, spot existence, edge existence, circle existence, line existence Location: Match location, match calibration Logic tool: If module, condition judge, logic judge, combination judge, character comparison, calculator Measurement: L2L angle, diameter measurement, brightness analysis, contrast measurement, width measurement, P2L measurement, greyscale size, line angle, edge width measurement Recognition: OCR, code recognition	3.45 μm	1/2.9"	1408 × 1024	60 fps	Mono	8/12/16 mm	A

Model	Vision tool	Pixel size	Sensor size	Resolution	Max. frame rate	Mono/color	Focal length	Label
MV-SC5016C	Count: Pattern count, spot count, edge count Defect detection: Exception detection Existence: Pattern existence, spot existence, edge existence, circle existence, line existence Location: Match location, match calibration Logic tool: If module, condition judge, logic judge, combination judge, character comparison, calculator Measurement: Color size, L2L angle, diameter measurement, brightness analysis, contrast measurement, width measurement, P2L measurement, greyscale size, line angle, edge width measurement Recognition: Color recognition, color contrast, OCR, code recognition	3.45 μm	1/2.9"	1408 × 1024	60 fps	Color	8/12/16 mm	A
MV-SC5050M	Count: Pattern count, spot count, edge count Defect detection: Exception detection Existence: Pattern existence, spot existence, edge existence, circle existence, line existence Location: Match location, match calibration Logic tool: If module, condition judge, logic judge, combination judge, character comparison, calculator Measurement: L2L angle, diameter measurement, brightness analysis, contrast measurement, width measurement, P2L measurement, greyscale size, line angle, edge width measurement Recognition: OCR, code recognition	3.2 μm	1/1.7"	2368 × 1760	40 fps	Mono	12/16 mm	A
MV-SC5060M	Count: Pattern count, spot count, edge count Defect detection: Exception detection Existence: Pattern existence, spot existence, edge existence, circle existence, line existence Location: Match location, match calibration Logic tool: If module, condition judge, logic judge, combination judge, character comparison, calculator Measurement: L2L angle, diameter measurement, brightness analysis, contrast measurement, width measurement, P2L measurement, greyscale size, line angle, edge width measurement Recognition: OCR, code recognition	2.4 μm	1/1.8"	3072 × 2048	30 fps	Mono	12 mm	A
MV-SC5060M-00C-NNN	Count: Pattern count, spot count, edge count Defect detection: Exception detection Existence: Pattern existence, spot existence, edge existence, circle existence, line existence Location: Match location, match calibration Logic tool: If module, condition judge, logic judge, combination judge, character comparison, calculator Measurement: L2L angle, diameter measurement, brightness analysis, contrast measurement, width measurement, P2L measurement, greyscale size, line angle, edge width measurement Recognition: OCR, code recognition	2.4 μm	1/1.8"	3072 × 2048	30 fps	Mono	/	B
MV-SC5120M-00C-NNN	Count: Pattern count, spot count, edge count Defect detection: Exception detection Existence: Pattern existence, spot existence, edge existence, circle existence, line existence Location: Match location, match calibration Logic tool: If module, condition judge, logic judge, combination judge, character comparison, calculator Measurement: L2L angle, diameter measurement, brightness analysis, contrast measurement, width measurement, P2L measurement, greyscale size, line angle, edge width measurement Recognition: OCR, code recognition	3.2 μm	1"	4096 × 3072	24 fps	Mono	/	B

Model	Vision tool	Pixel size	Sensor size	Resolution	Max. frame rate	Mono/color	Focal length	Label
MV-SC5200M-00C-NNN	Count: Pattern count, spot count, edge count Existence: Pattern existence, spot existence, edge existence, circle existence, line existence Location: Match location, match calibration Logic tool: If module, condition judge, logic judge, combination judge, character comparison, calculator Measurement: L2L angle, diameter measurement, brightness analysis, contrast measurement, width measurement, P2L measurement, greyscale size, line angle, edge width measurement Recognition: OCR, code recognition	2.4 μm	1"	5440 × 3648	20 fps	Mono	/	B

Dimension

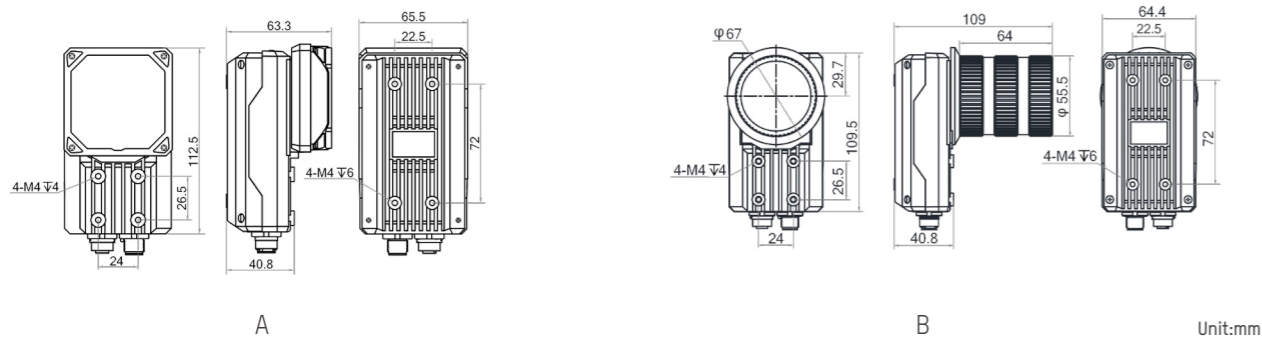

I/O Power Cables	Standard	High Softness	Elbow
3m	MV-IDA-P-M12A12pF-open-ST-3m	MV-IDA-P-M12A12pF-open-HF-3m	--
5m	MV-IDA-P-M12A12pF-open-ST-5m	MV-IDA-P-M12A12pF-open-HF-5m	MV-ACP-M12A12pF(up)-open-ST-5m
7m	MV-IDA-P-M12A12pF-open-ST-7m	--	--
10m	MV-IDA-P-M12A12pF-open-ST-10m	MV-IDA-P-M12A12pF-open-HF-10m	--
15m	MV-IDA-P-M12A12pF-open-ST-15m	--	--
20m	--	MV-IDA-P-M12A12pF-open-HF-20m	--
30m	MV-IDA-P-M12A12pF-open-ST-30m	--	--

Gigabit Network Cable	Standard	High Softness
3m	MV-IDA-E-M12A8pF-RJ45-ST-3m	MV-IDA-E-M12A8pF-RJ45-HF-3m
5m	MV-IDA-E-M12A8pF-RJ45-ST-5m	MV-IDA-E-M12A8pF-RJ45-HF-5m
7m	MV-IDA-E-M12A8pF-RJ45-ST-7m	--
10m	MV-IDA-E-M12A8pF-RJ45-ST-10m	MV-IDA-E-M12A8pF-RJ45-HF-10m
15m	MV-IDA-E-M12A8pF-RJ45-ST-15m	--
20m	--	MV-IDA-E-M12A8pF-RJ45-HF-20m
30m	MV-IDA-E-M12A8pF-RJ45-ST-30m	--

Let us customize machine vision platforms to your needs

Power Supply	Power Adapter	Switching Power Supply	Lens	SC5000 M12-mount	SC5000 C-mount (install Lens Cap)	SC5000 C-mount (not install Lens Cap)
Model	MSA-C1500IC12.0-18P-CN	LRS-150F-24	6mm	BHYB0856-12S	MAX: Ø48 mm × 62 mm with Lens	ALL
			12mm	BHP1256-12S		
			16mm	BHP1656-12S		

Lens Cap	Model	Light source	Model
Transparent	MV-SC3000-C-NN	White	MV-SC3000-L-WB
Semi-polarization	MV-SC3000-C-HP	Blue	MV-SC3000-L-BB
Polarization	MV-SC3000-C-FP	Red	MV-SC3000-L-RB
		Near-infrared	MV-SC3000-L-IB

Display Equipment	Model	Mounting Component	Model
Expansion Box	MV-SV100	Standard	V024-Mounting Component
	MV-SV400		
Touch Screen	MV-VT1010-008G50		

Contact us for brand new, refurbished or used Equipment

SC7000Pro Series Smart Camera

SC7000Pro Series Smart Camera is embedded with high-performance AI platform. Combined with traditional algorithms and AI algorithms, it can provide powerful help for complex and diverse detection scenarios such as defect detection, classification, OCR and positioning, .etc. The highly integrated product form gives a new standard for visual detection of intelligent manufacturing.

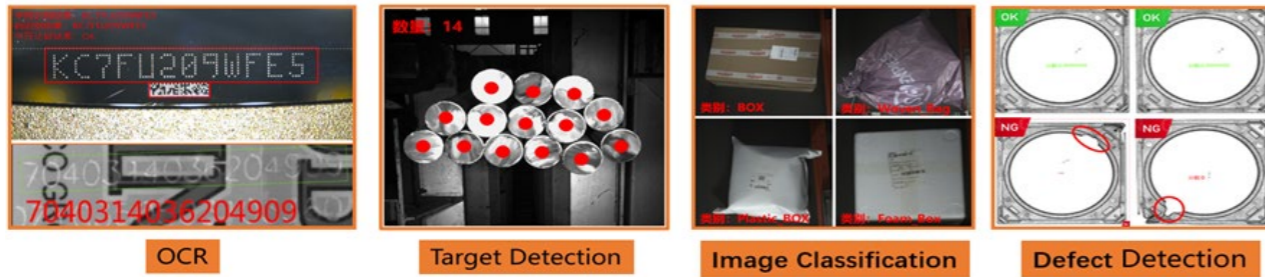

- High-performance Deep Learning Algorithm

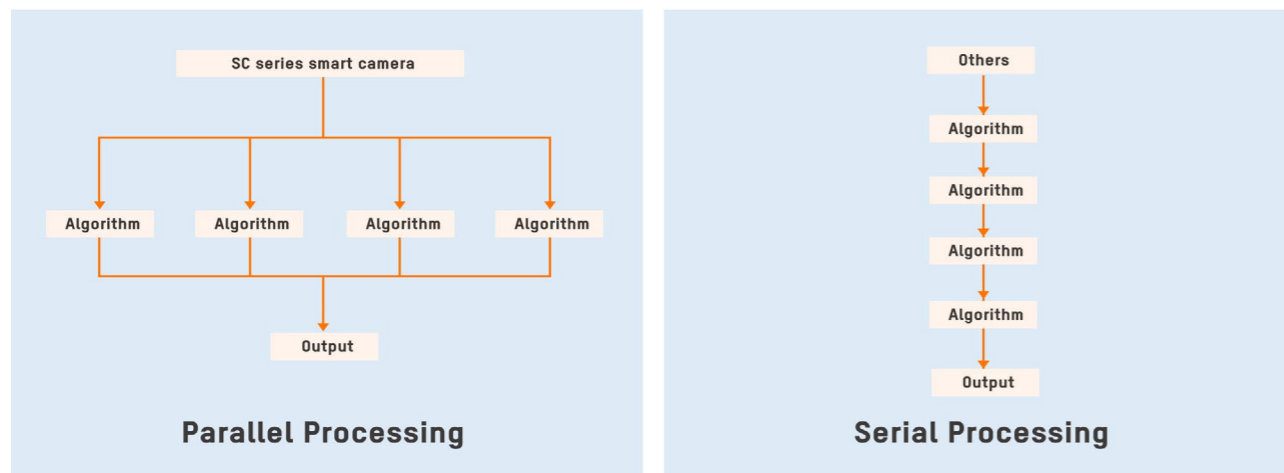

- Multi-thread processing to improve algorithm processing efficiency

Specifications



Model	Vision tool	Pixel size	Sensor size	Resolution	Max. frame rate	Mono/color	Focal length	Label
MV-SC7016PM	Count: Pattern count, spot count, edge count Defect detection: Exception detection Existence: Pattern existence, spot existence, edge existence, circle existence, line existence Location: Match location, match calibration Logic tool: If module, condition judge, logic judge, combination judge, string comparison, calculator Measurement: L2L angle, diameter measurement, brightness analysis, contrast measurement, width measurement, P2L measurement, greyscale size, line angle, edge width measurement Recognition: OCR, code recognition, DL classification, DL object detection	3.45 μm	1/2.9"	1408 × 1024	60 fps	Mono	8/12/16 mm	A

Model	Vision tool	Pixel size	Sensor size	Resolution	Max. frame rate	Mono/color	Focal length	Label
MV-SC7016PC	Count: Pattern count, spot count, edge count Defect detection: Exception detection Existence: Pattern existence, spot existence, edge existence, circle existence, line existence Location: Match location, match calibration Logic tool: If module, condition judge, logic judge, combination judge, character comparison, calculator Measurement: Color size, L2L angle, diameter measurement, brightness analysis, contrast measurement, width measurement, P2L measurement, greyscale size, line angle, edge width measurement Recognition: Color recognition, color contrast, OCR, code recognition, DL classification, DL object detection	3.45 μm	1/2.9"	1408 × 1024	60 fps	Color	12/16 mm	A
MV-SC7050PM	Count: Pattern count, spot count, edge count Defect detection: Exception detection Existence: Pattern existence, spot existence, edge existence, circle existence, line existence Location: Match location, match calibration Logic tool: If module, condition judge, logic judge, combination judge, string comparison, calculator Measurement: L2L angle, diameter measurement, brightness analysis, contrast measurement, width measurement, P2L measurement, greyscale size, line angle, edge width measurement Recognition: OCR, code recognition, DL classification, DL object detection	3.2 μm	1/1.7"	2368 × 1760	40 fps	Mono	12 mm	A
MV-SC7060PM	Count: Pattern count, spot count, edge count Defect detection: Exception detection Existence: Pattern existence, spot existence, edge existence, circle existence, line existence Location: Match location, match calibration Logic tool: If module, condition judge, logic judge, combination judge, string comparison, calculator Measurement: L2L angle, diameter measurement, brightness analysis, contrast measurement, width measurement, P2L measurement, greyscale size, line angle, edge width measurement Recognition: OCR, code recognition, DL classification, DL object detection	2.4 μm	1/1.8"	3072 × 2048	30 fps	Mono	8/12 mm	A
MV-SC7060PM-00C-NNN	Count: Pattern count, spot count, edge count Defect detection: Exception detection Existence: Pattern existence, spot existence, edge existence, circle existence, line existence Location: Match location, match calibration Logic tool: If module, condition judge, logic judge, combination judge, string comparison, calculator Measurement: L2L angle, diameter measurement, brightness analysis, contrast measurement, width measurement, P2L measurement, greyscale size, line angle, edge width measurement Recognition: OCR, code recognition, DL classification, DL object detection	2.4 μm	1/1.8"	3072 × 2048	30 fps	Mono	/	B

Model	Vision tool	Pixel size	Sensor size	Resolution	Max. frame rate	Mono/ color	Focal length	Label
MV-SC7120PM-00C-NNN	Count: Pattern count, spot count, edge count Defect detection: Exception detection Existence: Pattern existence, spot existence, edge existence, circle existence, line existence Location: Match location, match calibration Logic tool: If module, condition judge, logic judge, combination judge, string comparison, calculator Measurement: L2L angle, diameter measurement, brightness analysis, contrast measurement, width measurement, P2L measurement, greyscale size, line angle, edge width measurement Recognition: OCR, code recognition, DL classification, DL object detection	3.2 μm	1"	4096 × 3072	24 fps	Mono	/	B
MV-SC7200PM-00C-NNN	Count: Pattern count, spot count, edge count Defect detection: Exception detection Existence: Pattern existence, spot existence, edge existence, circle existence, line existence Location: Match location, match calibration Logic tool: If module, condition judge, logic judge, combination judge, string comparison, calculator Measurement: L2L angle, diameter measurement, brightness analysis, contrast measurement, width measurement, P2L measurement, greyscale size, line angle, edge width measurement Recognition: OCR, code recognition, DL classification, DL object detection	2.4 μm	1"	5440 × 3648	20 fps	Mono	/	B

Dimension

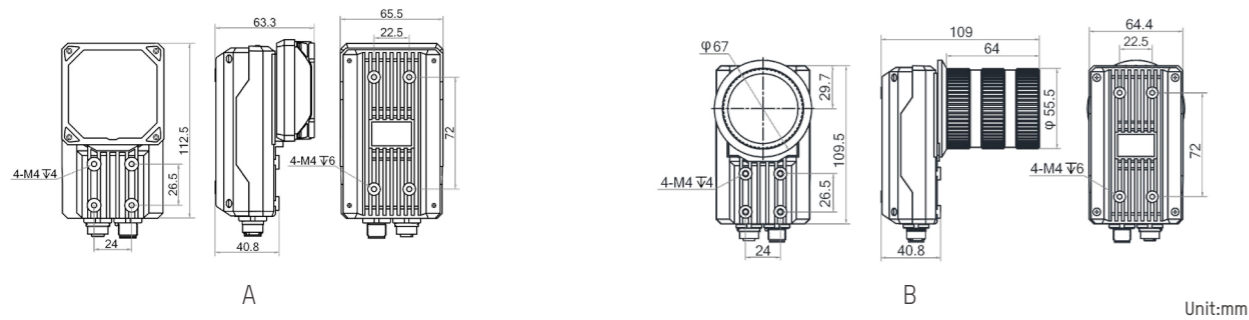

Unit:mm



I/O Power Cables	Standard	High Softness	Elbow
3m	MV-IDA-P-M12A12pF-open-ST-3m	MV-IDA-P-M12A12pF-open-HF-3m	--
5m	MV-IDA-P-M12A12pF-open-ST-5m	MV-IDA-P-M12A12pF-open-HF-5m	MV-ACP-M12A12pF(up)-open-ST-5m
7m	MV-IDA-P-M12A12pF-open-ST-7m	--	--
10m	MV-IDA-P-M12A12pF-open-ST-10m	MV-IDA-P-M12A12pF-open-HF-10m	--
15m	MV-IDA-P-M12A12pF-open-ST-15m	--	--
20m	--	MV-IDA-P-M12A12pF-open-HF-20m	--
30m	MV-IDA-P-M12A12pF-open-ST-30m	--	--



Gigabit Network Cable	Standard	High Softness
3m	MV-IDA-E-M12A8pF-RJ45-ST-3m	MV-IDA-E-M12A8pF-RJ45-HF-3m
5m	MV-IDA-E-M12A8pF-RJ45-ST-5m	MV-IDA-E-M12A8pF-RJ45-HF-5m
7m	MV-IDA-E-M12A8pF-RJ45-ST-7m	--
10m	MV-IDA-E-M12A8pF-RJ45-ST-10m	MV-IDA-E-M12A8pF-RJ45-HF-10m
15m	MV-IDA-E-M12A8pF-RJ45-ST-15m	--
20m	--	MV-IDA-E-M12A8pF-RJ45-HF-20m
30m	MV-IDA-E-M12A8pF-RJ45-ST-30m	--



Power Supply	Power Adapter	Switching Power Supply
Model	MSA-C1500IC12.0-18P-CN	LRS-150F-24



Lens	SC5000 M12-mount	SC5000 C-mount (install Lens Cap)	SC5000 C-mount (not install Lens Cap)
6mm	BHYB0856-12S	MAX: Ø48 mm × 62 mm with Lens	ALL
12mm	BHP1256-12S		
16mm	BHP1656-12S		

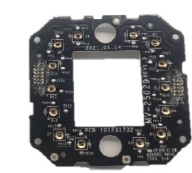

Lens Cap	Model
Transparent	MV-SC3000-C-NN
Semi-polarization	MV-SC3000-C-HP
Polarization	MV-SC3000-C-FP

Light source	Model
White	MV-SC3000-L-WB
Blue	MV-SC3000-L-BB
Red	MV-SC3000-L-RB
Near-infrared	MV-SC3000-L-IB



Display Equipment	Model
Expansion Box	MV-SV100 MV-SV400
Touch Screen	MV-VT1010-008G50



Mounting Component	Model
Standard	V024-Mounting Component

Contact us for brand new, refurbished or used Equipment

Let us customize machine vision platforms to your needs

SCMVS client

SCMVS client is an application software independently developed by HIKROBOT for smart cameras. It supports visual detection of images acquired by the device in real time or imported into the device, and can edit, manage and store the device scheme, which can meet the requirements of various machine vision applications such as positioning, measurement, recognition and deep learning applications.

Performance characteristics

- Support multiple platforms, compatible with Windows 32/64/10 bit operating system.
- Simple interaction, facilitated the process of configuration mode, and only four steps to complete the plan to build.
- Support interface data statistics and camera operation monitoring.
- Support I/O, communication, time calibration, firmware upgrades, passwords and other Settings.
- Support a key set camera parameters, automatically adjust the brightness focus and white balance.
- Support query operation log, equipment storage and import the pictures.

SCMVS

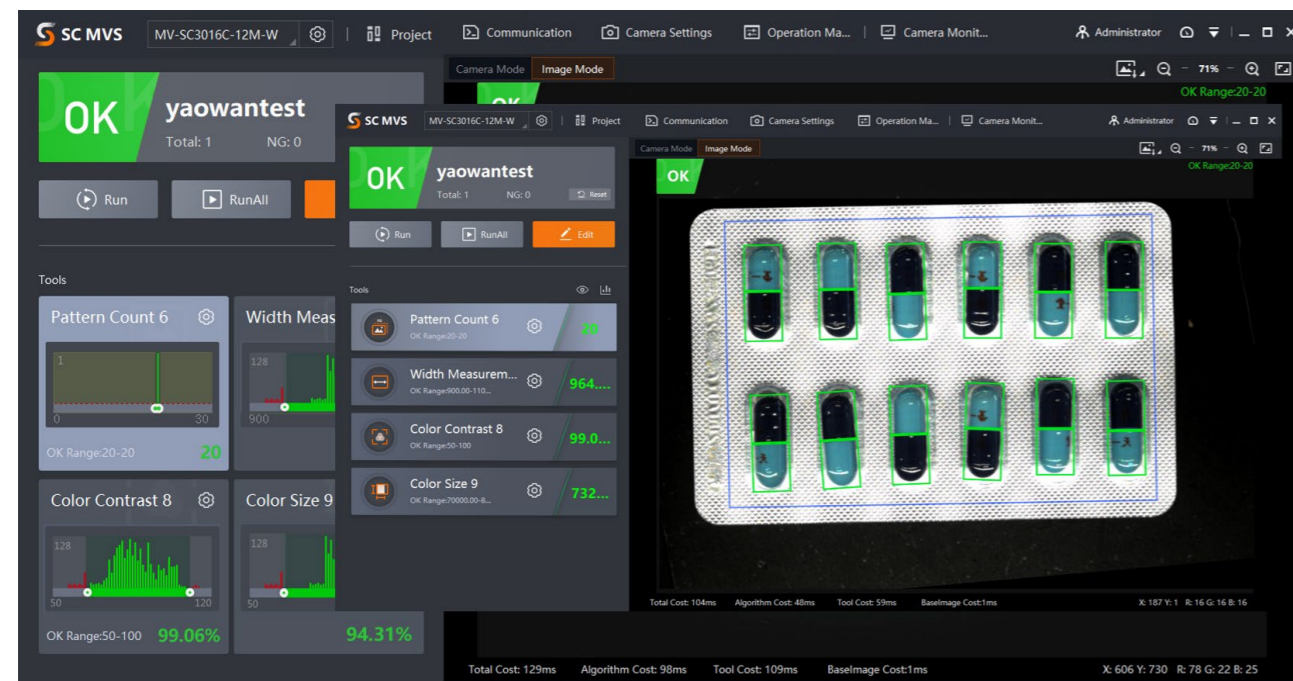

Contact us for brand new, refurbished or used Equipment

Let us customize machine vision platforms to your needs

Performance and Application of Smart Code Reader

Product introduction

In the industrial application scenario, barcode marking is a very important information storage medium, mainly applied to product information, supply chain information, production information and transportation information marking. Information collection is the basis for the formation of industrial IOT, and the acquisition of barcode information is often realized by means of code readers. In industrial scenes, the uncontrollable quality of coding, fast beat, high reading rate requirements, and harsh external use environment are the factors that determine higher requirements for industrial code reader products.



Key Features

- Rich product models, covering 0.4-20MP resolutions
- Built-in deep learning code reading algorithm, models trained by a large number of samples
- Millisecond reading efficiency, easy to cope with high-speed reading scenarios
- Support mainstream industrial communication protocols, system data interfacing more easily and stably
- Deep optimization for difficult codes to achieve over 99.95% read rate in complex scenarios
- IP65 or higher protection level, high-strength anti-drop and anti-dust design, to meet the harsh industrial application scenarios

Performance



- 1D code PPM requires 0.85mil or more, 2D code PPM requires 2.5mil or more
- Support coding rating score



- Support autofocus, one key parameter adjustment

Industry Cases

Lithium Industry

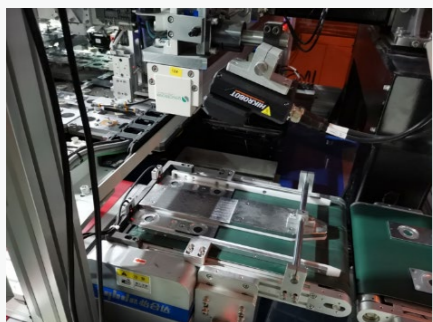

Battery top cover sheet DM code reading

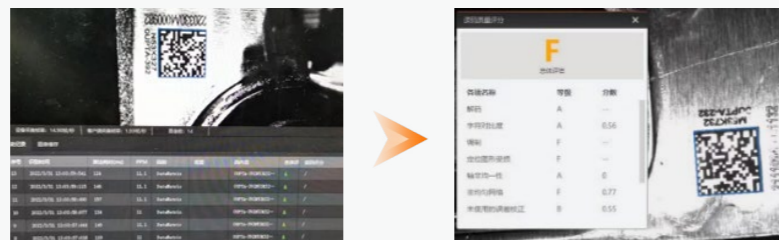

Identify the DM code on the top cover piece of lithium battery, metal reflective material. ID5050 smart code reader with polarized lens hood to overcome reflections, DM code stable identification, read the code level close, read the code rate of 99.99% or more.

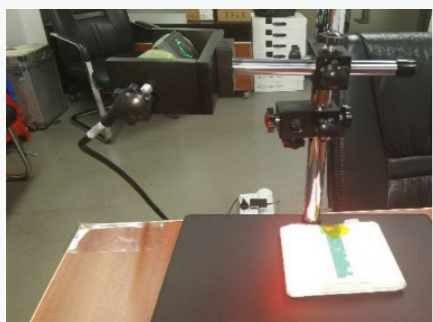

Battery cell green film code reading

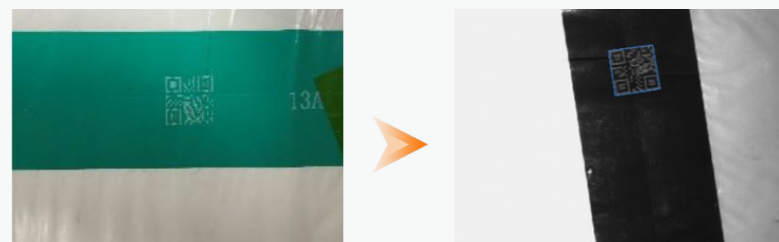

After the battery cells are wound/stacked, the termination tape is usually applied for the insulation fixation of the termination part of the cells, and the quality of the cells is traced through the QR code, and the code reading rate of this solution reaches more than 99.99%.



Logistics line pallet barcode reading

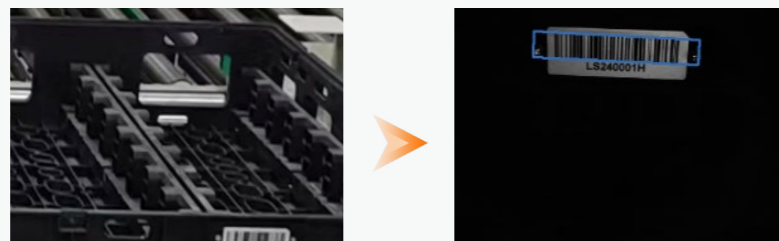

Intelligent logistics system is the connecting link between various systems, and the barcode information on the pallet is used to achieve battery tracking, management, status and other information. The solution's code is repeatedly used leading to easy dirty wear and low contrast, but the reading rate reaches more than 99.99%

Photovoltaic Industry



Silicon bar 2D code reading

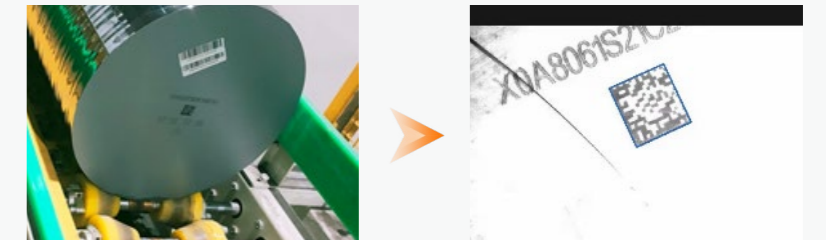

In the photovoltaic industry, after processing silicon ingots into silicon rods, the 2D code printed by laser on the end face of the rods needs to be read. The solution achieves stable reading with poor consistency and a code reading rate of over 99.9%.



Panel ID code reading



The Code39 code on the surface needs to be read before the panel leaves the factory. The solution 1D code stable recognition, read code rate of 99.6% or more, and the read code information uploaded to the user MES system and binding bar code information.

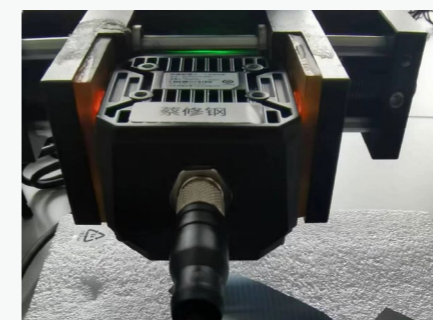

Very small code reading on silicon wafer

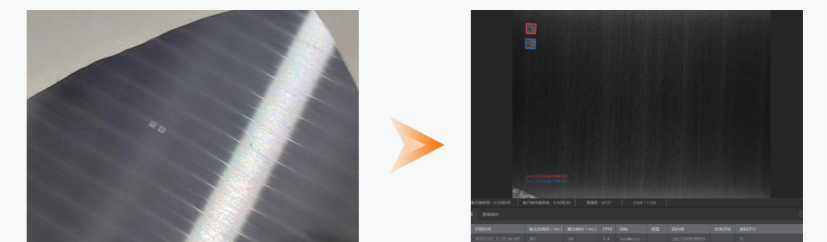

The DM code on the silicon wafer is manufactured through a special laser engraving process. The ID series industrial code reader with high-resolution accessories has the characteristics of small installation space and uniform imaging to achieve very small code reading with low contrast.

Automotive Industry



ECU cover code reading

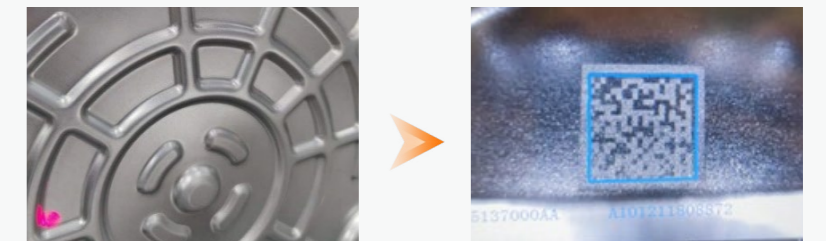

After producing an automotive ECU (Automotive Electronic Control Unit), a protective cover needs to be installed on the surface and a white 2D code printed on the surface. The solution overcomes the code quality problems of distorted reflection, low contrast and high speed rotation, and the code reading rate reaches more than 99.9%.



Automotive casting part code reading

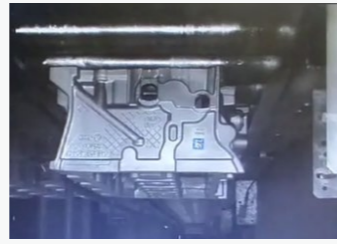

Different casting parts DM code engraving position is different and there is depth of field. The solution is highly migratable and reusable, with a code reading rate of over 99.9%.

PCB Industry

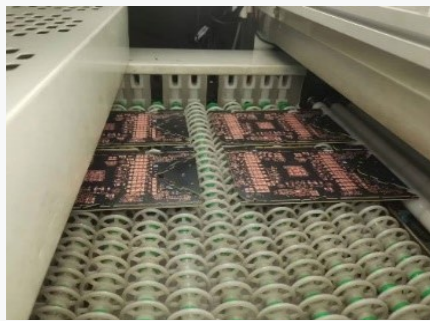

PCB board traceability code reading

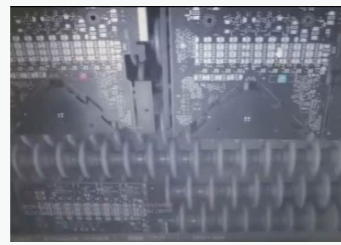

The finished production of PCB boards, read the 2D code on the assembly line, the code is small, the field of view requirements are large, and the barcode needs to be read steadily in motion. The solution achieves a large field of view to read small size codes, and the reading rate reaches more than 99.5%.



Multiple base color PCB board reading codes

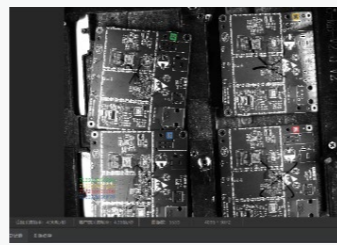
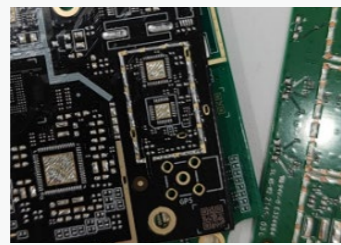

Multi-background color 2D code reading, including both QR code and DM code. The solution achieves stable QR code recognition with a read rate of 99.9% or more.

3C Industry



Very small code reading

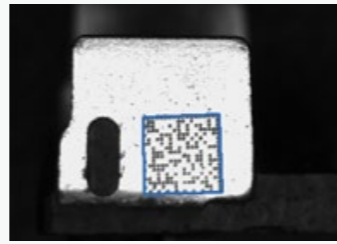
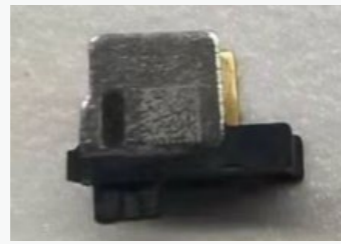

With the continuous upgrade of automated production line and engraving process, the size of QR code is getting smaller and smaller. ID series industrial readers with high resolution accessories ensure stable reading of very small codes.

E-commerce logistics Industry

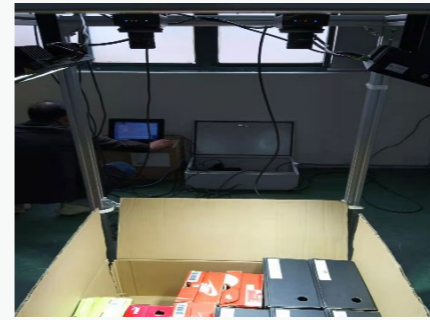

Shoe box reading code

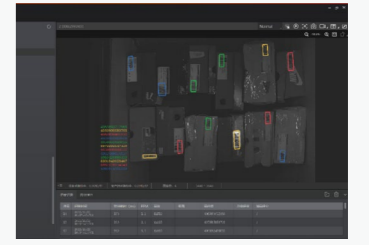

The 1D code recognition of this scene has a large field of view (more than 800mm on the long side), high code accuracy (around 8mils), and large depth of field difficulty. The program 1D code stable recognition, read code rate reached more than 99.9%.



Parcel barcode reading

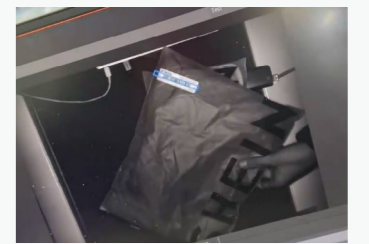

The code reader recognizes the parcel 2D code and does material sorting according to the barcode content. The solution solves the problem of distortion and folds in the code quality, efficient and stable recognition, and the reading rate reaches more than 99.9%.

Food and medicine Industry



High-speed dynamic code reading for soy sauce bottle cap

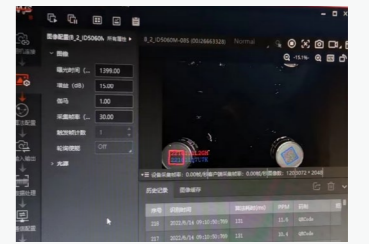

The two master-slave relationship cameras recognize the QR code on the bottle cap, overcoming the problems of high-speed code reading, distorted reflection, low contrast, and high-beat data fusion, with a code reading rate of over 99%.

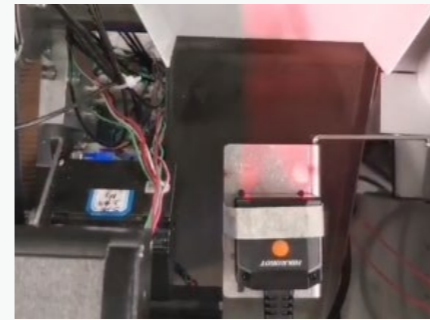

Medical test tube code reading

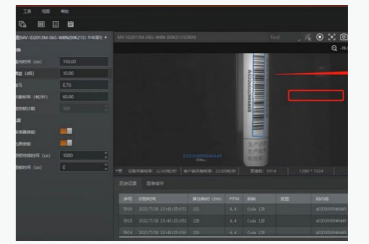

Identify the Code128 code of the test tube bottle, the barcode may appear in any position of the test tube bottle, overcome the problems of distortion reflection and high speed movement, the reading rate reaches more than 99.9%.

Smart Code Reader

■ ID2000 Series Smart Code Reader

As a compact industrial barcode reader, ID2000 series can be embedded in automated machine equipment and other automated assembly line proximity barcode reading applications. Support common 1D, 2D and DPM codes, the patented lighting design provides high-quality image lighting.

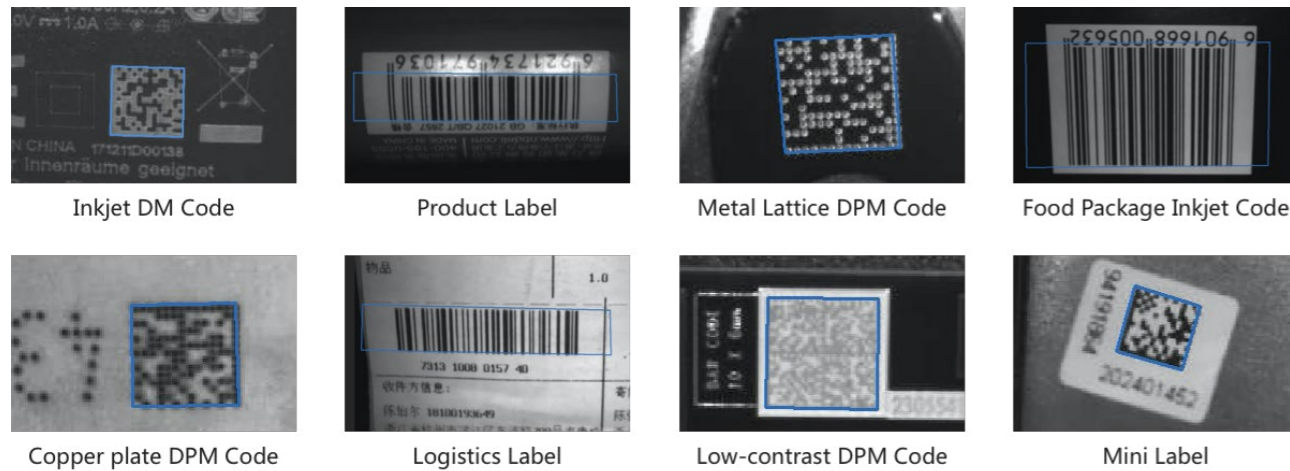

- Reliable reading performance

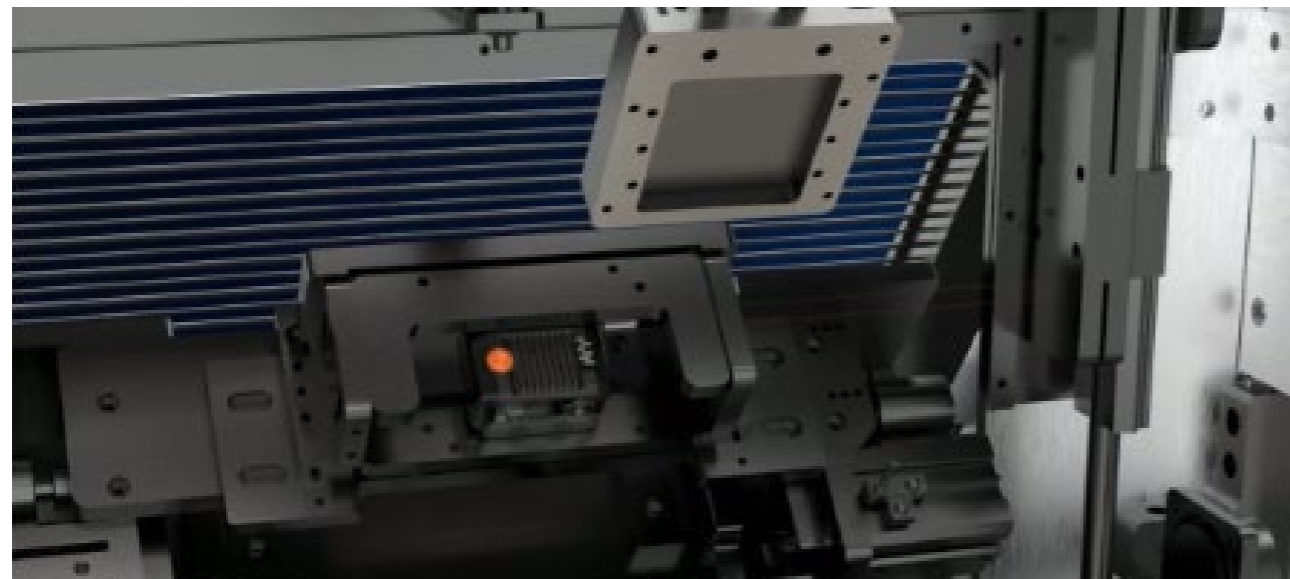

- Ultra-compact size

Specifications



Model	Resolution	Max. frame rate	Max. reading speed	Data interface	Max. power consumption	Focal Length	Working/Focus distance	Label
MV-ID2004M-06S-xBN	704 × 540	60 fps	41 codes/sec	Fast Ethernet	10.6 W@24 VDC	6.72 mm	40-120 mm, adjusting focus manually supported	A
MV-ID2004M-06S-xBN-U	704 × 540	60 fps	38 codes/sec	USB2.0	4.6 W@5 VDC	6.72 mm	40-120 mm, adjusting focus manually supported	A

Model	Resolution	Max. frame rate	Max. reading speed	Data interface	Max. power consumption	Focal Length	Working/Focus distance	Label
MV-ID2004M-16T	704 × 540	60 fps	45 codes/sec	Fast Ethernet	11 W@12 VDC	16 mm	100 - 400 mm	C
MV-ID2010M-05M-WLR	1280 × 800	50 fps	34 codes/sec	Fast Ethernet	6,24 W@24 VDC	5 mm	110 mm	B
MV-ID2010M-05M-WLR-U	1280 × 800	50 fps	32 codes/sec	USB2.0	4,4 W@5 VDC	5 mm	110 mm	B
MV-ID2013M-06S	1280 × 1024	60 fps	45 codes/sec	Fast Ethernet	10,6 W@24 VDC	6,72 mm	40-120 mm, adjusting focus manually supported	A
MV-ID2013M-16S-RBN	1280 × 1024	60 fps	45 codes/sec	Fast Ethernet	24 W@12 VDC	16 mm	105 - 150 mm, adjusting focus manually supported	E
MV-ID2013M-25S-RBN	1280 × 1024	60 fps	45 codes/sec	Fast Ethernet	24 W@12 VDC	25 mm	170 - 200 mm, adjusting focus manually supported	E
MV-ID2013M-00C-NNN	1280 × 1024	60 fps	45 codes/sec	Fast Ethernet	6 W@12 VDC	/	/	F
MV-ID2013EP-05-xBy	1280 × 1024	50 fps	30 codes/sec	Fast Ethernet	2,5 W@12 VDC	4,7 mm	/	D
MV-ID2013EP-05-xBy-U	1280 × 1024	50 fps	30 codes/sec	USB2.0	2,5 W@5 VDC	4,7 mm	/	D
MV-ID2013EM-05-xBy	1280 × 1024	50 fps	30 codes/sec	Fast Ethernet	2,5 W@12 VDC	4,7 mm	/	D
MV-ID2013EM-05-xBy-U	1280 × 1024	50 fps	30 codes/sec	USB2.0	2,5 W@5 VDC	4,7 mm	/	D
MV-ID2013EM-05N-xBy	1280 × 1024	50 fps	30 codes/sec	Fast Ethernet	2,5 W@12 VDC	4,7 mm	/	D
MV-ID2013EM-05N-xBy-U	1280 × 1024	50 fps	30 codes/sec	USB2.0	2,5 W@5 VDC	4,7 mm	/	D
MV-ID2013EM-05H-xBy	1280 × 1024	50 fps	30 codes/sec	Fast Ethernet	2,5 W@12 VDC	4,7 mm	/	D
MV-ID2013EM-05H-xBy-U	1280 × 1024	50 fps	30 codes/sec	USB2.0	2,5 W@5 VDC	4,7 mm	/	D
MV-ID2016M-06S-xBN	1408 × 1024	60 fps	45 codes/sec	Fast Ethernet	10,6 W@24 VDC	6,72 mm	40-120 mm, adjusting focus manually supported	A
MV-ID2016M-06S-xBN-U	1408 × 1024	60 fps	45 codes/sec	USB2.0	4,6 W@5 VDC	6,72 mm	40-120 mm, adjusting focus manually supported	A
MV-ID2016M-xT	1408 × 1024	60 fps	45 codes/sec	Fast Ethernet	11 W@12 VDC	6,7mm/10mm/16 mm	100 - 400 mm	C
MV-ID2016M-16S-RBN	1408 × 1024	60 fps	45 codes/sec	Fast Ethernet	10,6 W@24 VDC	16 mm	105 - 150 mm, adjusting focus manually supported	E
MV-ID2016M-25S-RBN	1408 × 1024	60 fps	45 codes/sec	Fast Ethernet	10,6 W@24 VDC	25 mm	170 - 200 mm, adjusting focus manually supported	E
MV-ID2016M-00C-NNN	1408 × 1024	60 fps	45 codes/sec	Fast Ethernet	6 W@12 VDC	/	/	F

Dimension

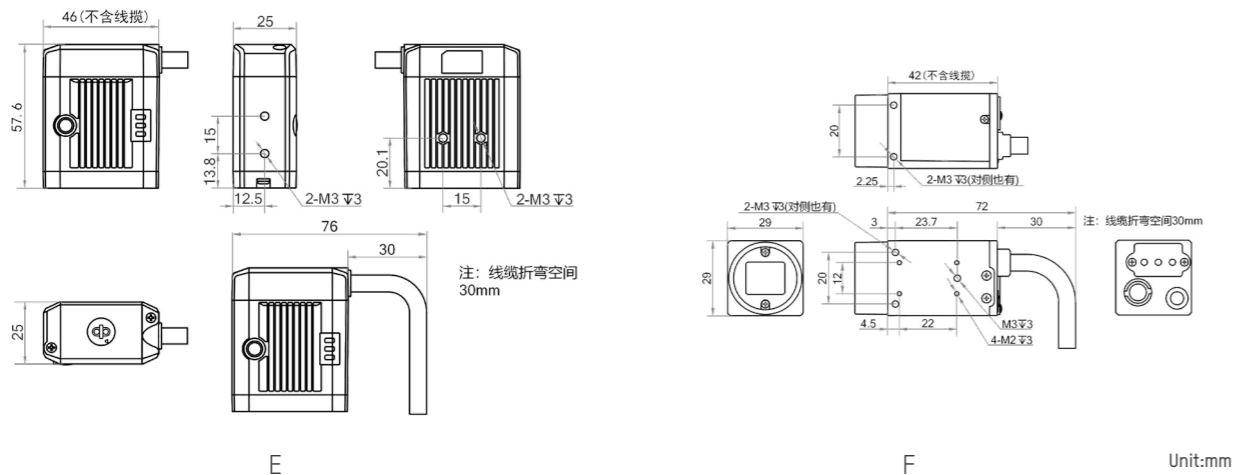
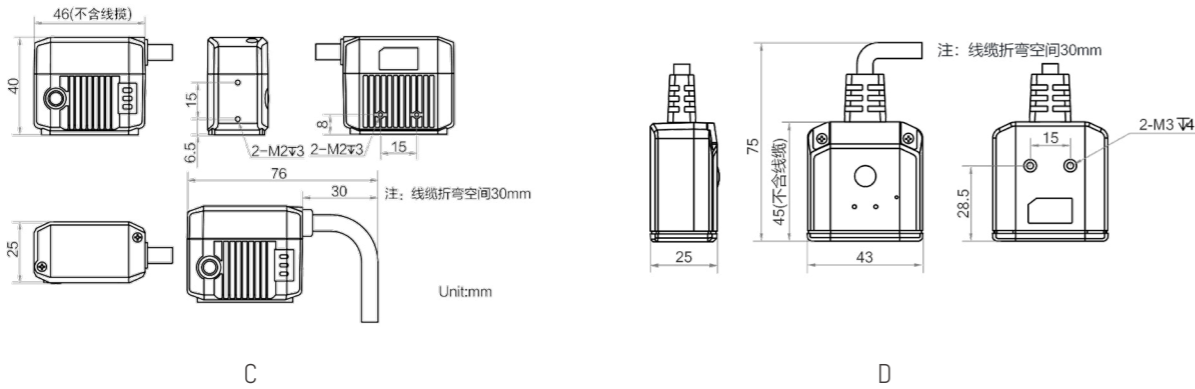
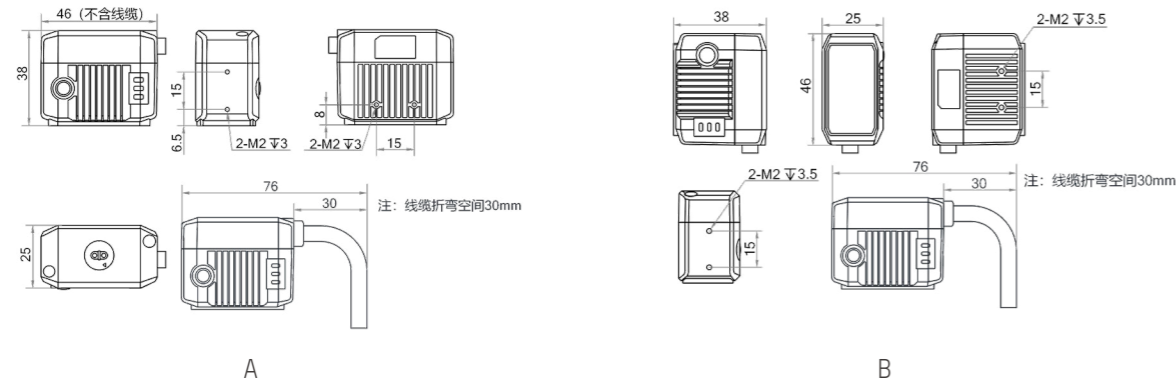

Accessories



I/O Power Cables	Standard	High Softness	Adaptive Camera
2m	MV-IDA-PE-M12A17pF-opensU2DB9-ST-2m	MV-IDA-PE-M12A17pF-opensU2DB9-HF-2m	ID2000M USB
3m	MV-IDA-PE-M12A17pF-opensRJ45DB9-ST-3m	MV-IDA-PE-M12A17pF-opensRJ45DB9-HF-3m	ID2000M GigE
5m	MV-IDA-PE-M12A17pF-opensRJ45DB9-ST-5m	Outcast line_ ID2000Composite function line_flexibility,5m,black	ID2000M GigE
10m	MV-IDA-PE-M12A17pF-opensRJ45DB9-ST-10m	---	ID2000M GigE
2m	External adapter_ID2013E ,HDB15M turn USB2.0	---	ID2000EM USB
2.5m	MV-ACP-DB9-USB2.0-ST-2.5m	---	ID2000EM USB
3.5m	External adapter_ID2013E	---	ID2000EM GigE



Power Supply	Power Adapter	Switching Power Supply	I/O Box	Model
Model	MSA-C1500IC12.0-18P-CN	KPL-060M-VI	Adaptive ID2000M Camera	MV-IDA-IO-33
			Adaptive ID2000EM Camera	MV-IDA-IO-22



Mounting Component	Model
Standard	ID2000 Mounting Component

Let us customize machine vision platforms to your needs

Contact us for brand new, refurbished or used Equipment

ID3000 Series Smart Code Reader

Based on the embedded deep-learning platform, ID3000 adopt compact & modular design. With easy debugging (mechanical focusing), automatic polarization function and controllable light source branching, ID3000 can be widely used in various code reading scenarios.

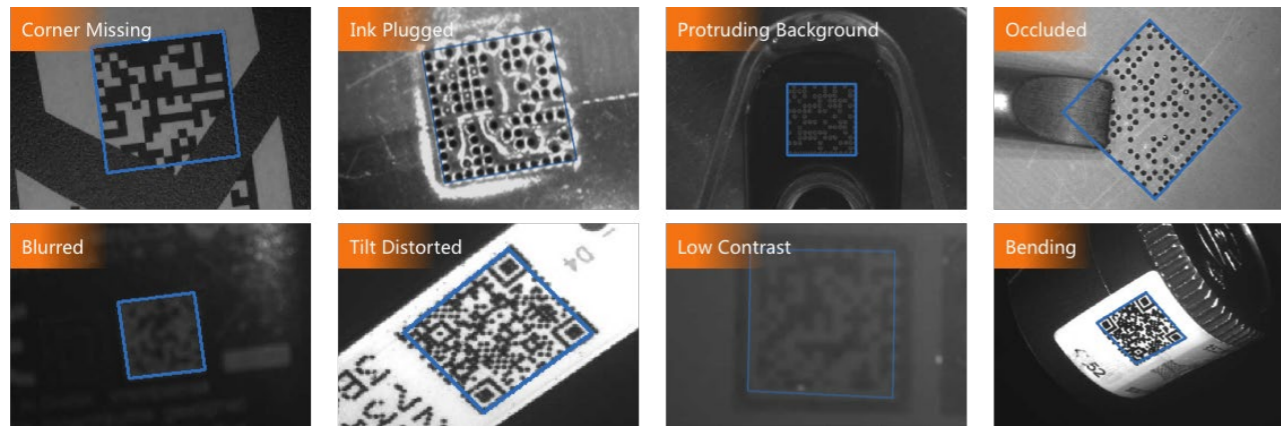

• Out-standing code reading effect

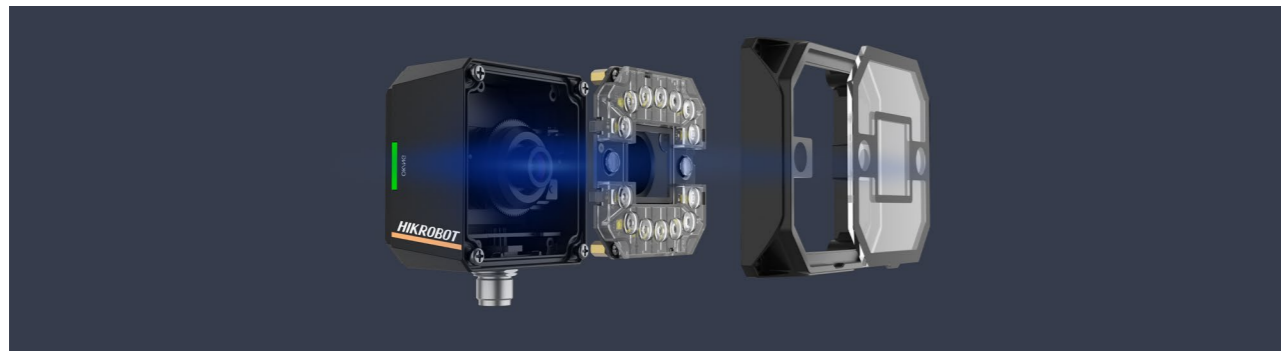

• Modular Design

Specifications



Model	Resolution	Max. frame rate	Max. reading speed	Data interface	Max. power consumption	Focal Length	Label
MV-ID3013PM	1280 × 1024	60 fps	84 codes/sec	Fast Ethernet	20 W@24 VDC	6/12/14.8 mm	A
MV-ID3016PM	1408 × 1024	60 fps	84 codes/sec	Fast Ethernet	20 W@24 VDC	6/12/14.8 mm	B
MV-ID3016XM*	1408 × 1024	60 fps	90 codes/sec	Fast Ethernet	20 W@24 VDC	6/12/16/25 mm	C
MV-ID3030XM*	2048 × 1536	60 fps	90 codes/sec	Fast Ethernet	20 W@24 VDC	6/12/16/25 mm	C
MV-ID3050PM	2368 × 1760	30 fps	60 codes/sec	Fast Ethernet	10.6 W@24 VDC	8/12/16/25 mm	A

Notice: * will be released soon.

Dimension

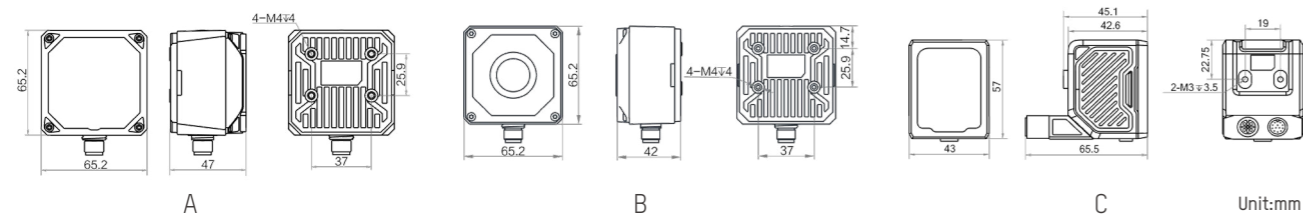

Accessories



I/O Power Cables	Standard	High Softness	Adaptive Camera
3m	MV-IDA-PE-M12A17pF-opensRJ45DB9-ST-3m	MV-IDA-PE-M12A17pF-opensRJ45DB9-HF-3m	MV-ACPE-M12A17F(back)-OPEN/RJ45-FL-3m
5m	MV-IDA-PE-M12A17pF-opensRJ45DB9-ST-5m	MV-ACPE-M12A17F-OPEN/RJ45-FL-5m	MV-IDA-PE-M12A17pF-RJ45M/DB9/Opens-SF-5m
10m	MV-IDA-PE-M12A17pF-opensRJ45DB9-ST-10m	MV-ACPE-M12A17F-OPEN/RJ45-FL-10m	MV-IDA-PE-M12A17pF-open/RJ45/DB9-HF-10m
15m	MV-ACP-M12A17pF-TB8pRJ45DB9F-ST-15m	MV-ACP-M12A17pF-TB8pRJ45DB9F-SF-15m	MV-IDA-PE-M12A17pF-opensRJ45DB9-HF-15m

Power Supply	Power Adapter	Switching Power Supply
Model	ADS-26FSG-12 12024EPCN	KPL-060M-VI

Lens	ID3013/ID3016	ID3050
6mm	BTY0640-MP	---
8mm	---	BHYB0856-12S
12mm	BTS1240-MP	BHP1256-12S
14.8mm	BTS1540-MP	---
16mm	---	BHP1656-12S
25mm	---	BHP2556-12S

Lens Cap	ID3013/ID3050	ID3016
Transparent	ID3050 transparent lens cap	ID3016 transparent lens cap
Semi-polarization	ID3050 Semi-polarization lens cap	---
Polarization	ID3050 polarization lens cap	ID3016 polarization lens cap
Diffusion	ID3050 diffusion lens cap	---

Light Source	ID3013/ID3050	ID3016 (BASE)	ID3016 (LED)
White	ID3050/ID3013 white light	ID3016 white light	ID3016 white light LED
Blue	ID3050/ID3013 blue light	ID3016 blue light	ID3016 blue light LED
Red	ID3050/ID3013 red light	ID3016 red light	ID3016 red light LED
Near-infrared	ID3050/ID3013 near-infrared light	ID3016 near-infrared light	---

Mounting Component	Model	IO Box	Model
Standard	V020-Mounting Component	Standard	MV-IDA-IO-33(N)

High Resolution Lens Cap	Model	Adapted Model
40mm	MV-IDA-C-Y-62-62-M1	MV-ID3050PM-16M-***
60mm	MV-IDA-C-Y-62-62-M2	

ID5000 Series Smart Code Reader

Based on multi-core deep learning processor, the full-featured code reader brings powerful code reading performance. Equipped with mechanical focus lens and various components, ID5000 can reach up to 20M pixels, suitable for various code reading applications.

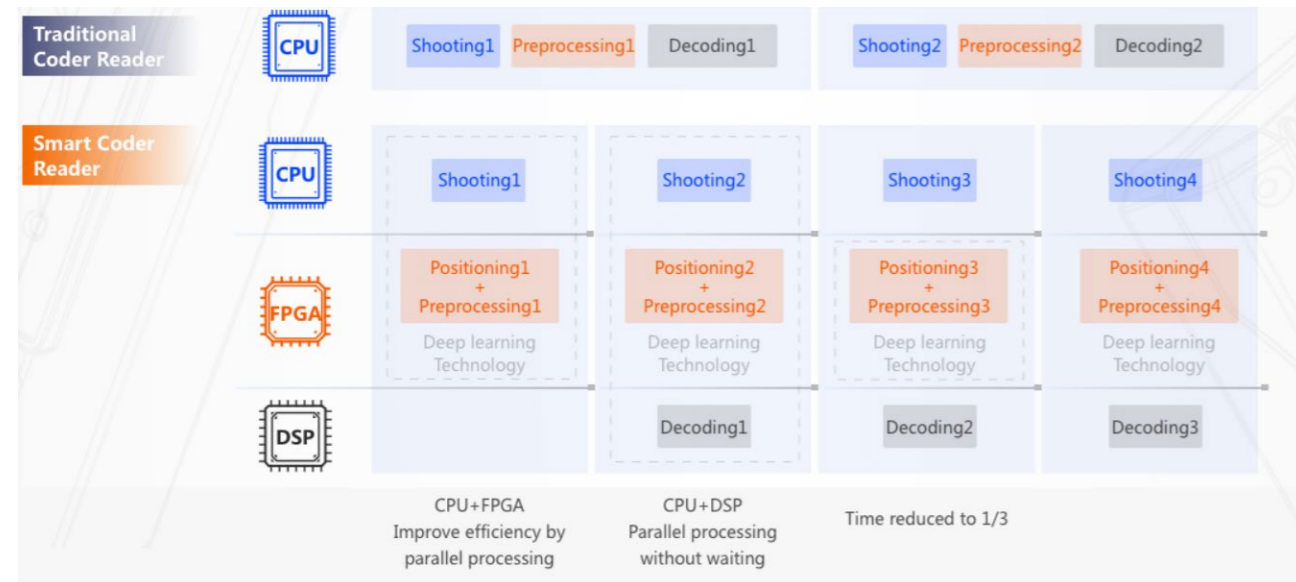

- Multi-core Processing

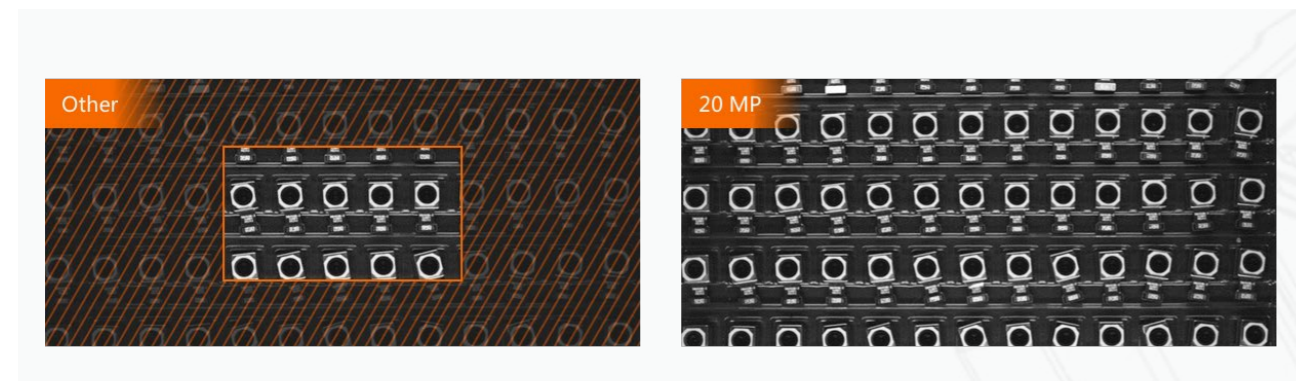

- High Accuracy & Wide View

Specifications



Model	Resolution	Max. frame rate	Max. reading speed	Data interface	Max. power consumption	Focal Length	Label
MV-ID5030M-xxS-WBN	2048 × 1536	60 fps	90 codes/sec	Gigabit Ethernet	60 W@24 VDC	8/12/16/25 mm	A
MV-ID5050M-xxS-WBN	2368 × 1760	40 fps	90 codes/sec	Gigabit Ethernet	60 W@24 VDC	8/12/16/25 mm	A
MV-ID5060M-xxS-WBN	3072 × 2048	30 fps	90 codes/sec	Gigabit Ethernet	20 W@24 VDC	8/12/16/25 mm	B
MV-ID5060M-00C-WBN	3072 × 2048	30 fps	90 codes/sec	Gigabit Ethernet	23 W@24 VDC	/	C
MV-ID5060M-00C-NNN	3072 × 2048	30 fps	90 codes/sec	Gigabit Ethernet	23 W@24 VDC	/	D
MV-ID5120M-00C-NNN	4096 × 3072	28 fps	84 codes/sec	Gigabit Ethernet	12 W@24 VDC	/	D
MV-ID5200M-00C-NNN	5440 × 3648	20 fps	36 codes/sec	Gigabit Ethernet	12 W@24 VDC	/	D

Notice: xx products with different focal Lengths

Dimension

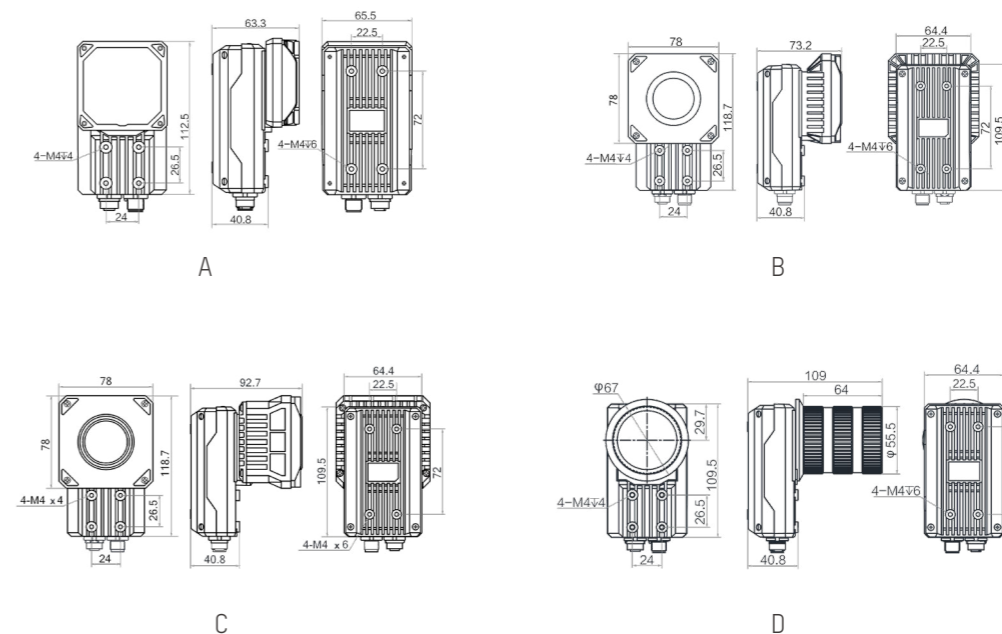

Unit:mm

Let us customize machine vision platforms to your needs

Contact us for brand new, refurbished or used Equipment

Accessories



I/O Power Cables	Standard	High Softness
3m	MV-IDA-P-M12A12pF-open-ST-3m	MV-IDA-P-M12A12pF-open-HF-3m
5m	MV-IDA-P-M12A12pF-open-ST-5m	MV-IDA-P-M12A12pF-open-HF-5m
7m	MV-IDA-P-M12A12pF-open-ST-7m	--
10m	MV-IDA-P-M12A12pF-open-ST-10m	MV-IDA-P-M12A12pF-open-HF-10m
15m	MV-IDA-P-M12A12pF-open-ST-15m	--
20m	--	MV-IDA-P-M12A12pF-open-HF-20m
30m	MV-IDA-P-M12A12pF-open-ST-30m	--

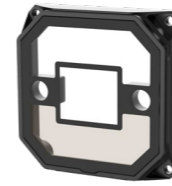

Lens Cap	ID5030/ID5050	ID5060
Transparent	ID5030/ID5050 transparent lens cap	ID5060 transparent lens cap
Semi-polarization	ID5030/ID5050 Semi-polarization lens cap	--
Polarization	ID5030/ID5050 polarization lens cap	ID5060 polarization lens cap
Diffusion	ID5030/ID5050 diffusion lens cap	ID5060 diffusion lens cap



Gigabit Network Cable	Standard	High Softness
3m	MV-IDA-E-M12A8pF-RJ45-ST-3m	MV-IDA-E-M12A8pF-RJ45-HF-3m
5m	MV-IDA-E-M12A8pF-RJ45-ST-5m	MV-IDA-E-M12A8pF-RJ45-HF-5m
7m	MV-IDA-E-M12A8pF-RJ45-ST-7m	--
10m	MV-IDA-E-M12A8pF-RJ45-ST-10m	MV-IDA-E-M12A8pF-RJ45-HF-10m
15m	MV-IDA-E-M12A8pF-RJ45-ST-15m	--
20m	--	MV-IDA-E-M12A8pF-RJ45-HF-20m
30m	MV-IDA-E-M12A8pF-RJ45-ST-30m	--

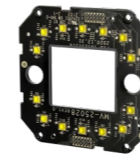

Light Source	ID5030/ID5050	ID5060
White	ID5030/ID5050 white light	ID5060 white light
Blue	ID5030/ID5050 blue light	ID5060 blue light
Red	ID5030/ID5050 red light	ID5060 red light
Near-infrared	ID5030/ID5050 near-infrared light	ID5060 near-infrared light



Power Supply	Power Adapter	Switching Power Supply
Model	PMC-24V150W1BA	KPL-060M-VI



Mounting Component	Model
Standard	V024-Mounting Component



Lens	ID5030/ID5050	ID5060	C-mount (install Lens Cap)	C-mount (not install Lens Cap)
8mm	BHYB0856-12S	BHC0856-05S	MAX: Φ 48 mm \times 62 mm with Lens	ALL
12mm	BHP1256-12S	BHC1256-05S		
16mm	BHP1656-12S	BHC1656-05S		
25mm	BHP2556-12S	BHC2556-05S		



AGS-TECH Inc.
 Phone: +1-505-550-6501 and +1-505-565-5102
 Fax: +1-505-814-5778
 Email: sales@agstech.net
 Web: http://www.agstech.net

Contact us for brand new, refurbished or used Equipment

Let us customize machine vision platforms to your needs

ID6000 Series Smart Code Reader

Image-based high-resolution barcode reader ID6000 is specialized for the logistics industry. ID6000 has especially developed in algorithm development to cope with various complex logistics code reading application scenarios.



• Powerful performance

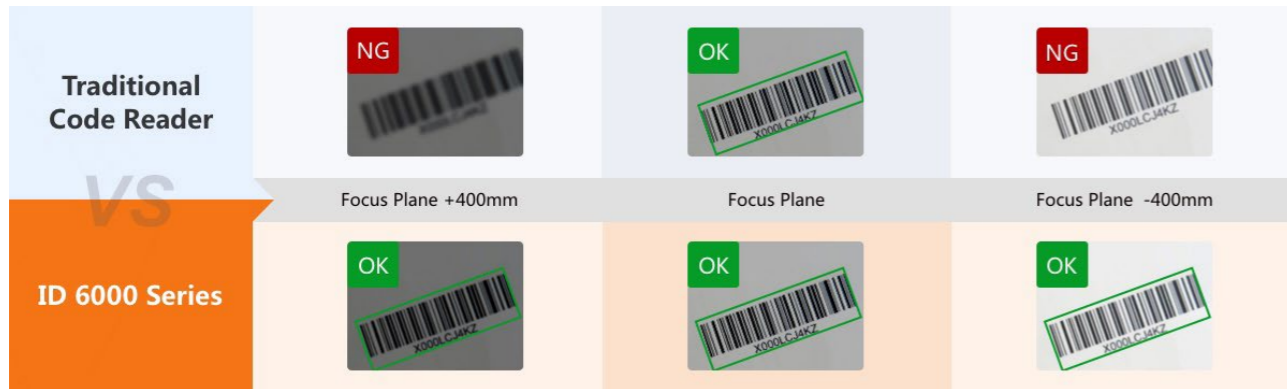

• Extra-wide field of view

Specifications

Model	Pixel size	Resolution	Max. frame rate	Max. reading speed	Data interface	Lens mount	Label
MV-ID6200EM-00C-NNG	2.4 μm	5440 × 3648	10 fps	30 codes/sec	Gigabit Ethernet	C	A
MV-ID6200M-00C-NNG	2.4 μm	5440 × 3648	20 fps	60 codes/sec	Gigabit Ethernet	C	B
MV-ID6089M-00C-NNG	3.45 μm	4096 × 2160	30 fps	90 codes/sec	Gigabit Ethernet	C	B



Dimension

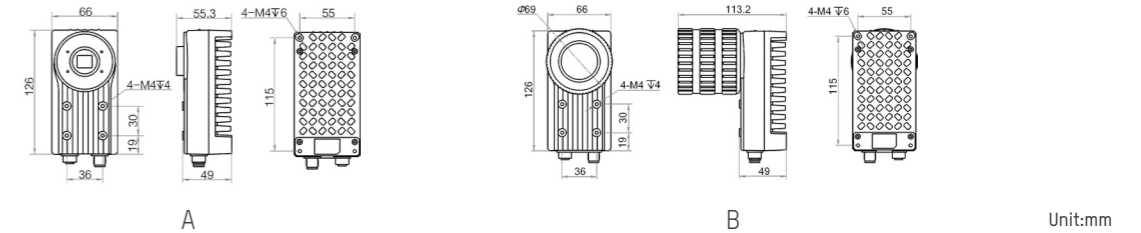

Accessories



Lens	10MP	12MP
6mm	MVL-HF0624M-10MP	--
8mm	MVL-HF0824M-10MP	MVL-KF0828M-12MP
12mm	MVL-HF1224M-10MP	MVL-KF1228M-12MP
16mm	MVL-HF1624M-10MP	MVL-KF1628M-12MP
20mm	MVL-KF2056M-10MP	--
25mm	MVL-HF2524M-10MP	MVL-KF2528M-12MP
35mm	MVL-HF3524M-10MP	MVL-KF3528M-12MP
50mm	MVL-HF5024M-10MP	MVL-KF5028M-12MP

Reading Light Source	Model
High power type	MV-LB-270-140-4030WL-A
High power type	MV-LB-230-230-4030WL-A

Controller	Model
VB2000 Series	MV-VB2100-120G
	MV-IPC-2302
	MV-IPC-2504
IPC2000 Series	MV-IPC-2504L
	MV-IPC-2504-2T
	MV-IPC-2504L-2T
	MV-IPC-2504-25661T
	MV-IPC-2506

Cable	Power Line of Camera	Network Cable of Camera	Trigger Line of Light	Connecting Line of Camera Power Line
3m	MV-ACC-02-2201-03m	MV-ACC-02-1101-03m		
5m	MV-ACC-02-2201-05m	MV-ACC-02-1101-05m		
7m	MV-ACC-02-2201-07m	MV-ACC-02-1101-07m	MV-ACC-02-T-light-07m	MV-ACC-02-link-0.5m
10m	MV-ACC-02-2201-10m	MV-ACC-02-1101-10m		
15m	MV-ACC-02-2201-15m	MV-ACC-02-1101-15m		

■ ID7000 Series Smart Code Reader

Based on the embedded platform, ID7000 series is developed according to the application scenarios and needs of the bottom surface of the logistics industry. With 48 particles of LED light source and integrated structure design, ID7000 can realize an ultra-wide coverage.

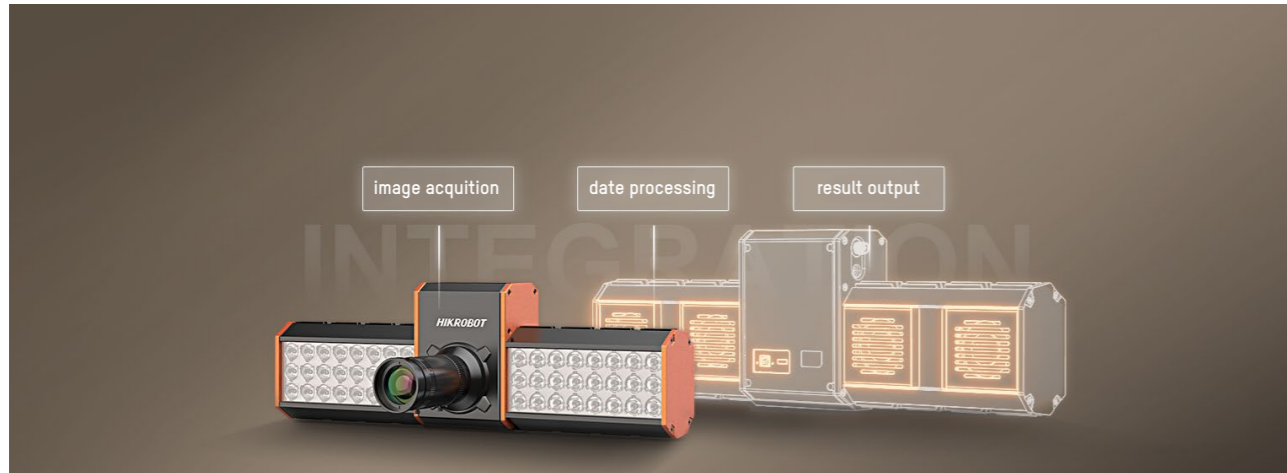
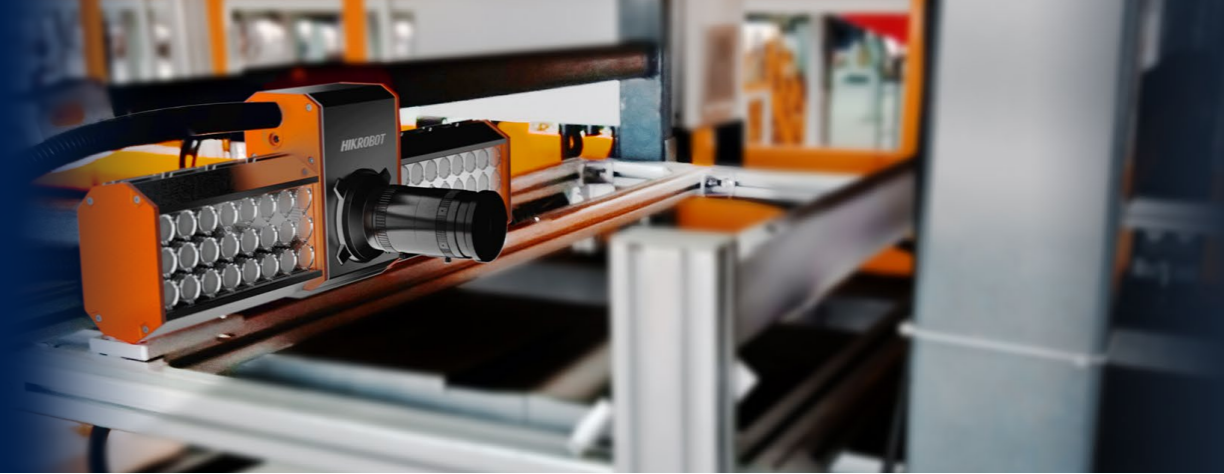

- Integrated design

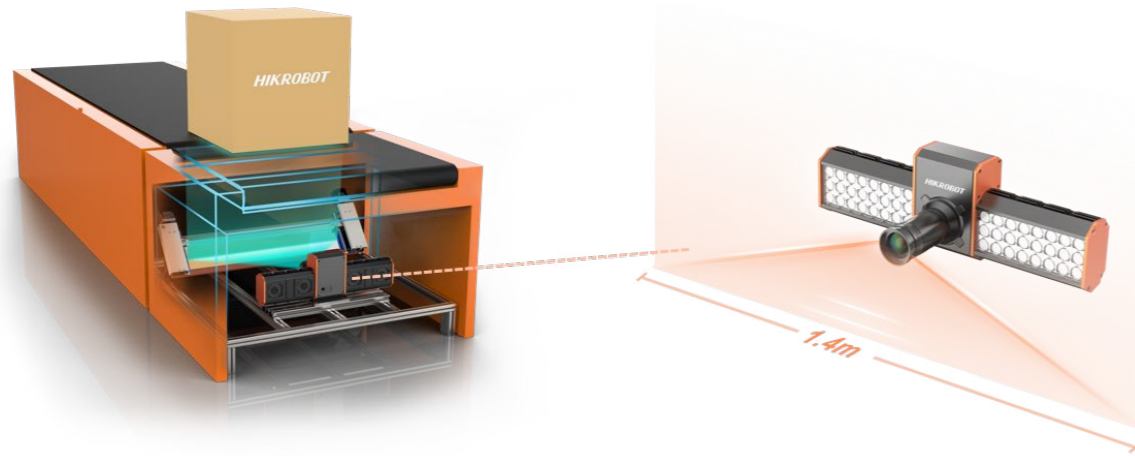

- Wide Coverage

Specifications

Model	Max. line frequency	Resolution	Data interface	Focal Length	Working distance	Field of view	Lens mount
MV-ID7080EM-35F-WHA	15 kHz	8K	Gigabit Ethernet	35 mm	1000 mm	1000 mm	F
MV-ID7080PM-35F-WHA	20 kHz	8K	Gigabit Ethernet	35 mm	1000 mm	1200 mm	F



Dimension

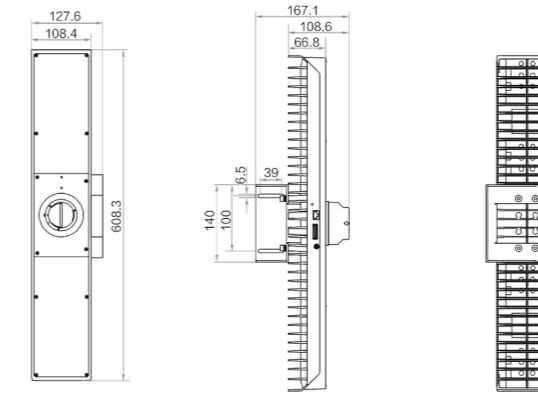

Unit:mm

Accessories



Mirror	Model
Mirror of Bottom	MV-ID7000-850mm-B
	MV-ID7000-1150mm-B
	MV-ID7000-550mm-B
	MV-ID7000-850mm-EB3.0



AGS-TECH Inc.
 Phone: +1-505-550-6501 and +1-505-565-5102
 Fax: +1-505-814-5778
 Email: sales@agstech.net
 Web: <http://www.agstech.net>

Let us customize machine vision platforms to your needs

PD Series Logistics Code Reader

As the core component of a code reading device, the product is divided into two categories: standard type and smart type. The product integrates the functions of image acquisition, data processing and result output. With its features of convenient use, excellent performance and rich supporting functions, it can be widely used in various types of code reading application scenarios.



- Flexible collocation and rapid deployment

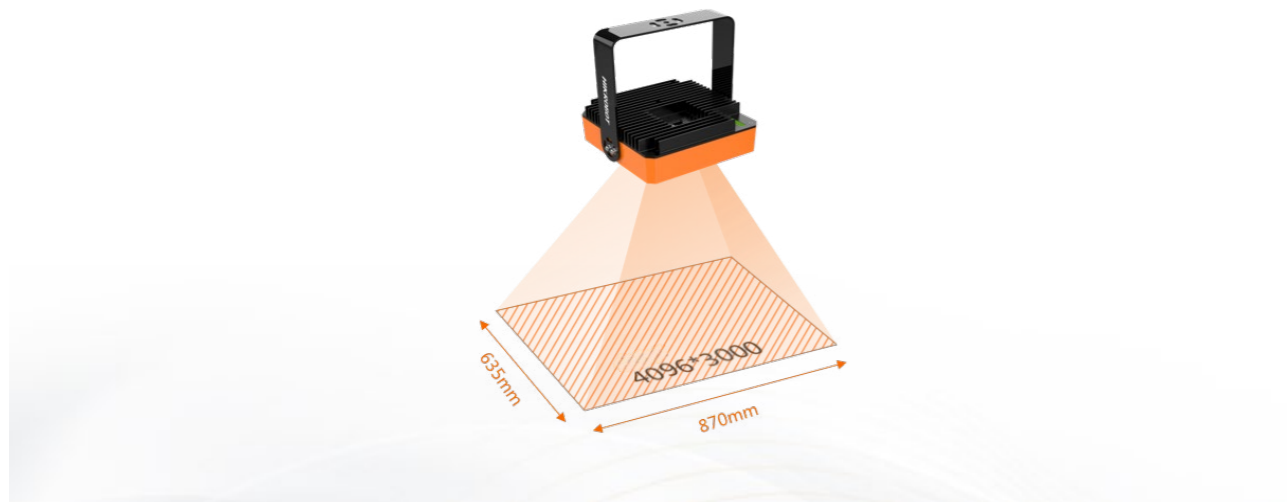

- Built-in embedded high performance processor

Specifications



Model	Type	Max. frame rate	Resolution	Focal Length	Working distance	Field of view	Depth of field
MV-PD010003-06M-12C	Standard type	15 fps	3072 × 2048	12 mm	900 mm	550 mm × 340 mm	500 mm
MV-PD010003-12M-16C	Standard type	5.5 fps	4024 × 3036	16 mm	1550 mm	730 mm × 550 mm	650 mm
MV-IDS012M-16C-C*	Smart type	10 fps	4096 × 3000	16 mm	1870 mm	870 mm × 635 mm	700 mm

Notice: * will be released soon.

Dimension

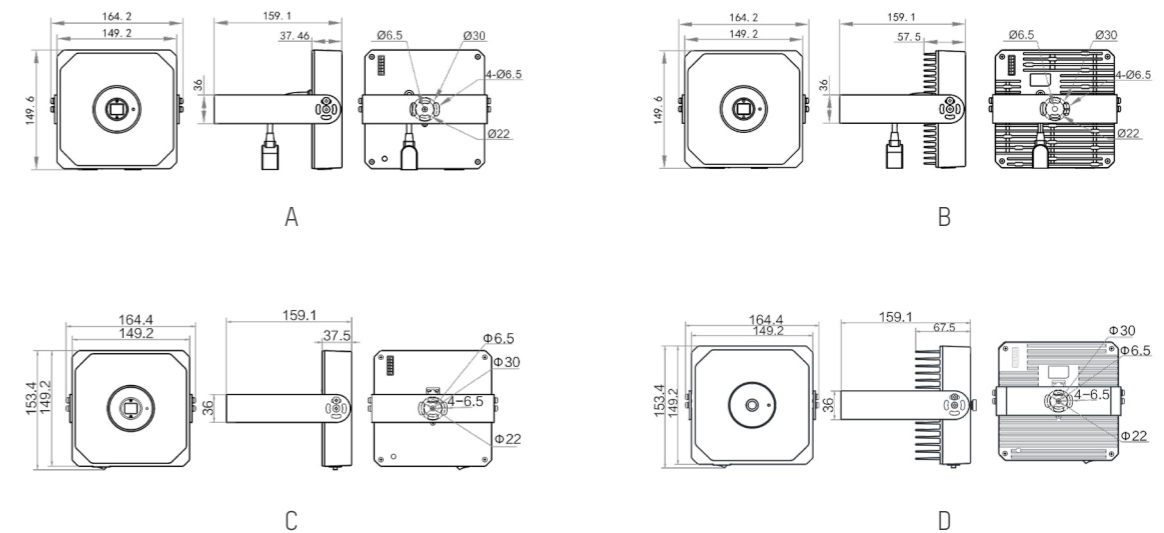

Unit:mm

Let us customize machine vision platforms to your needs

Contact us for brand new, refurbished or used Equipment

IDH Series Handheld Smart Code Reader

As a powerful handheld barcode scanner, the IDH series adopt a million-resolution global exposure sensor. With high-level protection, IDH has red/white fill light which can be automatically adjusted. Support USB/ network port, simple and convenient to use.

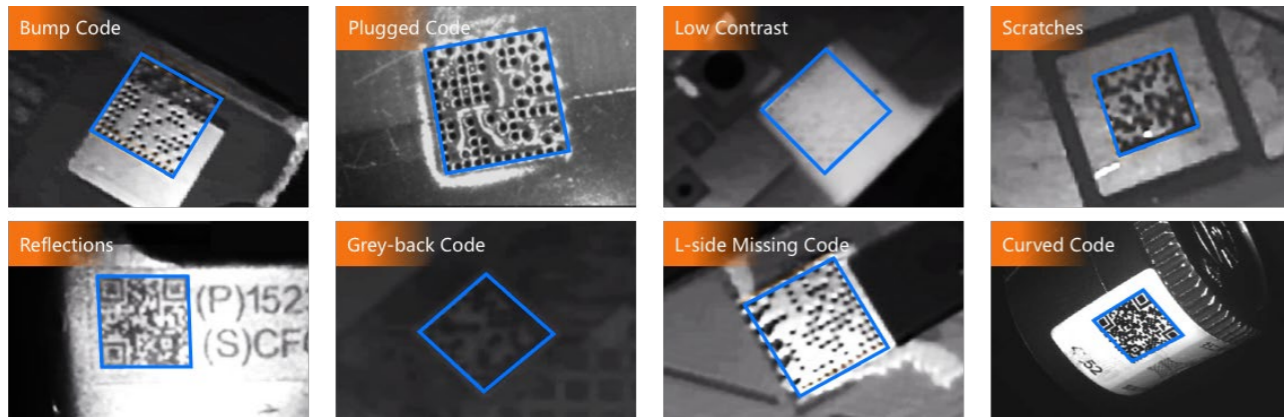

- Excellent DPM code identify function

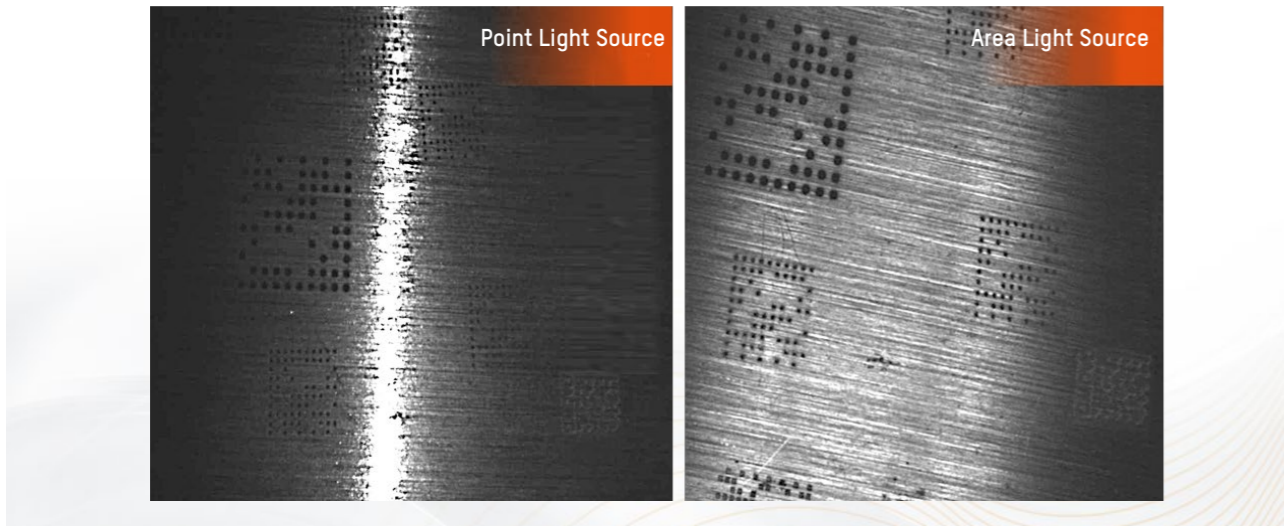

- Multi-light source design, adapt to more scenes

Specifications



Model	Resolution	Frame rate	Min. accuracy	Data interface	Max. power consumption	Focal length	Label
MV-IDH2003-03S-R1U*	640 × 480	24.9 fps	4 mil	USB2.0,DC terminal	USB2.0:1.5 W@5 VDC DC terminal:1.8 W@24 VDC	3.1 mm	A
MV-IDH2003B-03S-R1U*	640 × 480	24.9 fps	4 mil	USB2.0,DC terminal	Standby mode:0.8 W@ 3.8 VDC Working mode:1.6 W @ 3.8 VDC Sleep mode:0.6 W@ 3.8 VDC	3.1 mm	B
MV-IDH3013-05x-R1L	1280 × 1024	50 fps	S: 4 mil N: 3 mil	Fast Ethernet,RS-232,DC terminal	1.8 W@24 VDC	4.7 mm	C

Model	Resolution	Frame rate	Min. accuracy	Data interface	Max. power consumption	Focal length	Label
MV-IDH3013-05x-R1U	1280 × 1024	50 fps	S: 4 mil N: 3 mil	USB2.0,DC terminal	USB2.0:1.5 W@5 VDC DC terminal:1.8 W@24 VDC	4.7 mm	C
MV-IDH3013B-05x-R1	1280 × 1024	50 fps	S: 4 mil N: 3 mil	Fast Ethernet,RS-232,DC terminal	Standby mode:0.8 W@ 3.8 VDC Working mode:1.6 W @ 3.8 VDC Sleep mode:0.6 W@ 3.8 VDC	4.7 mm	D
MV-IDH3013B-05x-R1L	1280 × 1024	50 fps	S: 4 mil N: 3 mil	Bluetooth,Fast Ethernet,RS-232,DC terminal	Standby mode:0.8 W@ 3.8 VDC Working mode:1.6 W @ 3.8 VDC Sleep mode:0.6 W@ 3.8 VDC	4.7 mm	D
MV-IDH3013B-05x-R1U	1280 × 1024	50 fps	S: 4 mil N: 3 mil	Bluetooth,USB2.0,DC terminal	Standby mode:0.8 W@ 3.8 VDC Working mode:1.6 W @ 3.8 VDC Sleep mode:0.6 W@ 3.8 VDC	4.7 mm	D
MV-IDH5010-05-xR-L	1280 × 800	50 fps	S: 4 mil N: 3 mil	Fast Ethernet, RS-232	Standby mode:1.34 W@ 12 VDC Working mode:4.94 W @ 12 VDC	4.7 mm	E
MV-IDH5010-05-xR-U	1280 × 800	50 fps	S: 4 mil N: 3 mil	USB3.0	Standby mode:1.05 W@ 12 VDC Working mode:4.36 W @ 12 VDC	4.7 mm	E
MV-IDH7010P-07-xR-L	1280 × 800	50 fps	S: 4 mil N: 3 mil	Fast Ethernet,RS-232,DC terminal	6 W@24 VDC	6.7 mm	F
MV-IDH7010P-07-xR-U	1280 × 800	50 fps	S: 4 mil N: 3 mil	USB2.0,DC terminal	USB2.0:4.6 W@5 VDC DC terminal:6 W@24 VDC	6.7 mm	F
MV-IDH7010P-07-xR-LP	1280 × 800	50 fps	S: 4 mil N: 3 mil	/	6 W@24 VDC	6.7 mm	F
MV-IDH7010B-07-xR	1280 × 800	50 fps	S: 4 mil N: 3 mil	/	Standby mode:1.1 W@ 3.8 VDC Working mode:6.4 W@ 3.8 VDC Sleep mode:0.8 W@ 3.8 VDC	6.7 mm	G
MV-IDH7010B-07-xR-L	1280 × 800	50 fps	S: 4 mil N: 3 mil	/	Standby mode:1.1 W@ 3.8 VDC Working mode:6.4 W@ 3.8 VDC Sleep mode:0.8 W@ 3.8 VDC	6.7 mm	H
MV-IDH7010B-07-xR-U	1280 × 800	50 fps	S: 4 mil N: 3 mil	/	Standby mode:1.1 W@ 3.8 VDC Working mode:6.4 W@ 3.8 VDC Sleep mode:0.8 W@ 3.8 VDC	6.7 mm	H

Notice: * will be released soon.
x=S denotes the standard focus, x=N denotes the near focus

Dimension

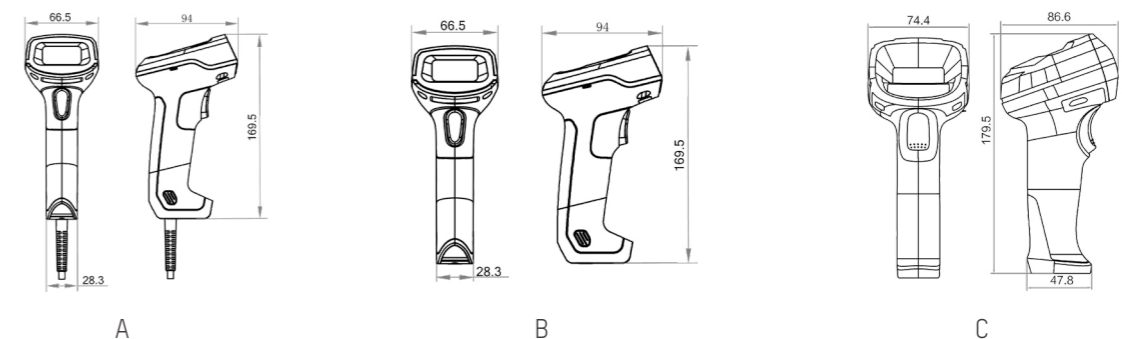

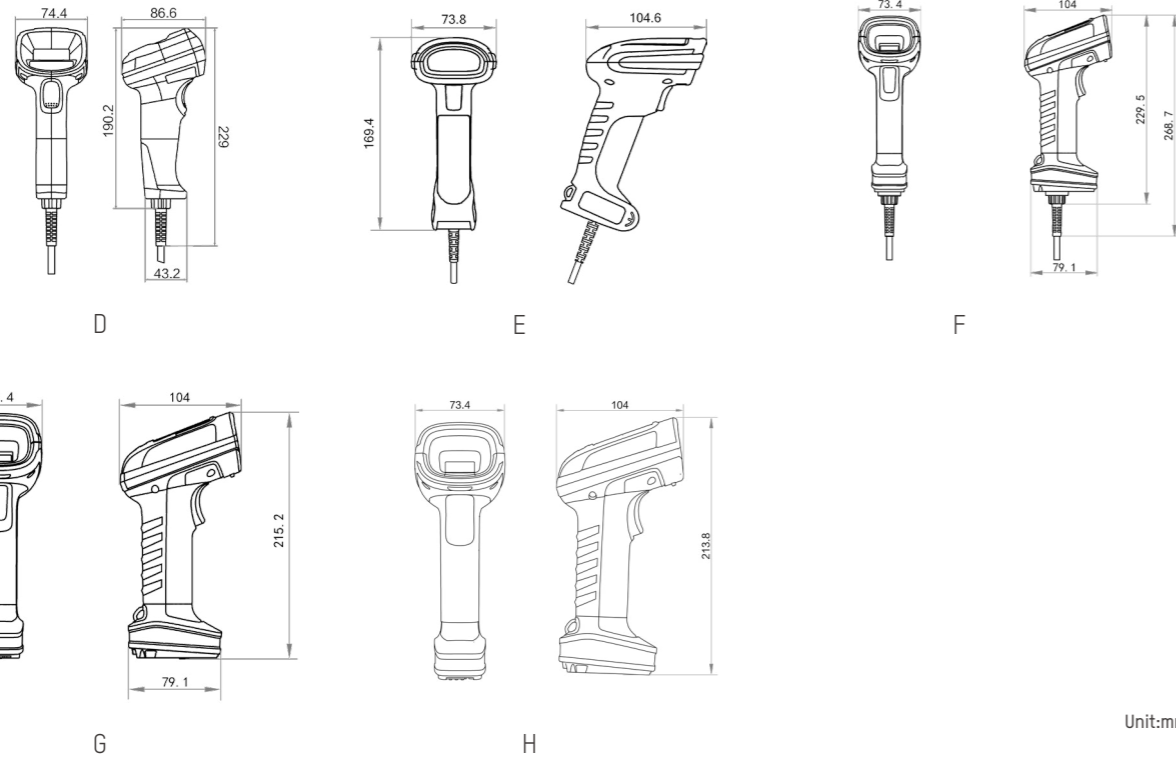

Unit:mm

Accessories



Power/IO Cable	IDH2003	IDH2003B	IDH3013	IDH3013B	IDH7010	IDH7010B
2.5m	Optional cable configuration_USB, Black Optional cable configuration_Serial, RS232, Black	Optional cable configuration_USB, Black, the base cable Optional cable configuration_Serial, RS232, Black, the base cable	Optional cable configuration_USB, 2.5m, Black, Spin Cover	Optional cable configuration_USB, 2.5m, Black	Optional cable configuration_USB, 2.5m, Black Optional cable configuration_USB, Spring wire	Optional cable configuration_USB, Black, the base cable
3m			Optional cable configuration_USB+Serial RS232, 2.5m, Black, Spin Cover	Optional cable configuration_Ethernet, 3m, Black, the base cable	Optional cable configuration_USB+Serial RS232, 3m, Black Optional cable configuration_Ethernet+POE, 3m, Black(only for POE model)	Optional cable configuration_Ethernet, Black, the base cable
5m	--	--	--	--	Optional cable configuration_Ethernet+Serial RS232, Spring wire	--



Bracket	Type
Handheld Scanner Bracket	Wall-mounted bracket
	Desktop stand

IDMVS Client

IDMVS client is an application software developed by Hikrobot exclusively for code reading cameras, which supports the debugging of all series of industrial code readers, handheld scanners, code reading modules and other code reading products. Through IDMVS, you can perform a series of debugging operations such as code reader focusing, parameter setting and establishing communication, etc. You can follow the seven-step guide bar on the left side of the software interface to complete the equipment setting and easily complete the preparation before the equipment comes online.

Key Features

- Directly connected to the code reader debugging, with interface operation for all code reading functions, easy to operate and start
- Real-time display of code reading effects for imaging optimization and debugging
- Integrated FTP client for direct local storage via FTP
- Provide SDK secondary development, support C, C++, C# development language
- Provide UI interface and other in-depth customization services to meet customer needs in all aspects

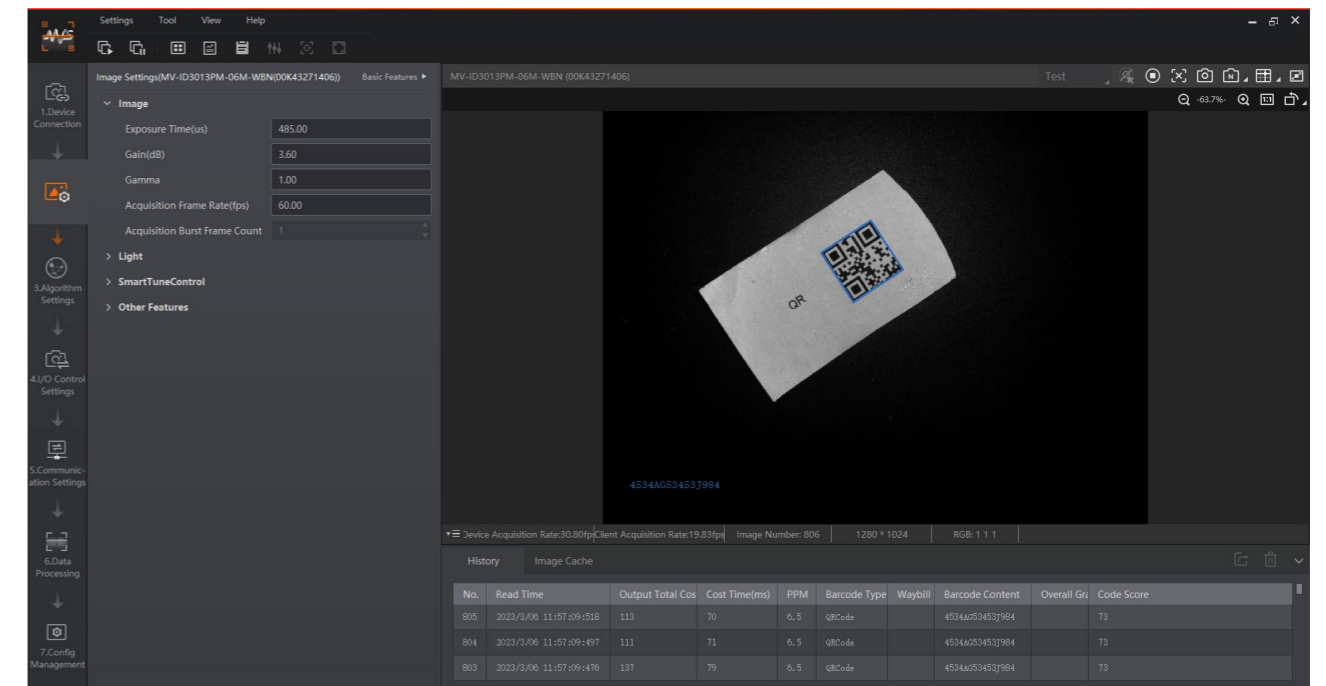

AGS-TECH Inc.

Phone: +1-505-550-6501 and +1-505-565-5102

Fax: +1-505-814-5778

Email: sales@agstech.net

Web: <http://www.agstech.net>

Let us customize machine vision platforms to your needs

Performance and Application of 3D Camera

Product Background

In the field of machine vision, upgrading from 2D vision to 3D vision can enable machines to understand the 3D physical world like humans, thus giving more possibilities to machine vision. hikrobot is committed to accelerating manufacturing automation upgrade with 3D technology, after years of research and development, we have now perfected our 3D product line including line laser stereo camera, RGB-D intelligent stereo camera, etc. Widely used in consumer electronics, electronics manufacturing, logistics and other industries.

Key Features

Strong robustness

The product is equipped with deep learning and HDR image algorithm, it has high accuracy and adaptability to ambient light, parcel type and workpiece material, ensuring high accuracy and reliability of the system.

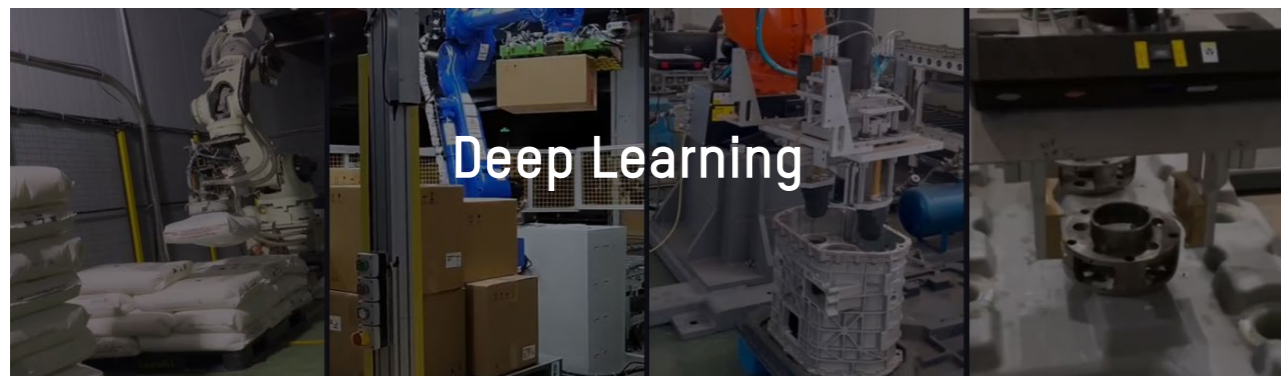

Wide field of view coverage

A variety of camera models, covering multiple working distances and field of view, and across a variety of technology types, so as to flexibly adapt to a variety of application scenarios.



Contact us for brand new, refurbished or used Equipment

High openness

Flexible SDK usage with comprehensive interface for easy secondary development.



High stability

The whole series is equipped with IP65 protection grade as standard, which is suitable for various harsh usage environments.



Let us customize machine vision platforms to your needs

3D Camera

Line Laser 3D Camera

Built-in high accuracy measurement algorithm and wider dynamic image processing algorithm, 3D cameras can output objects' size information in logistics and warehousing applications, a wider dynamic detection range, and stronger robustness ability.

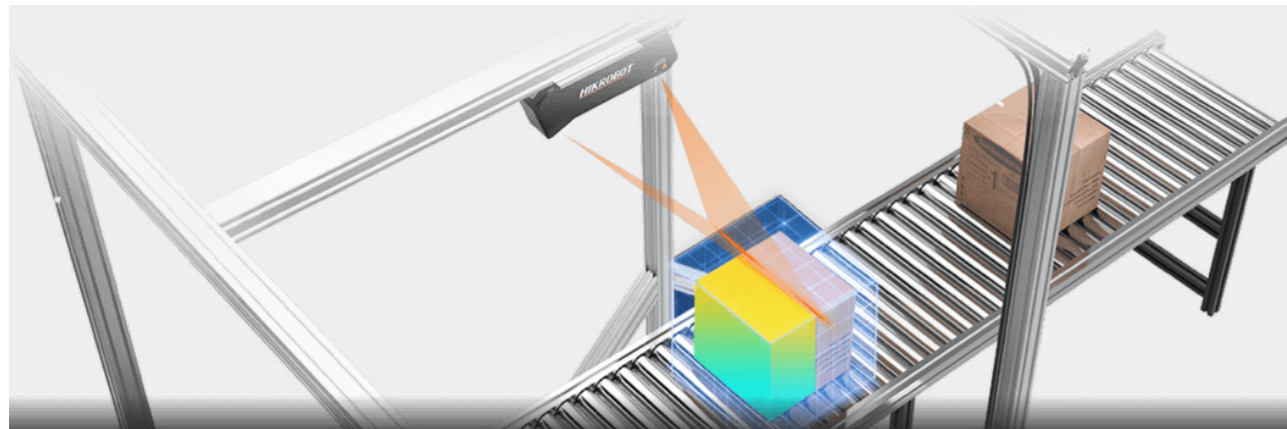

- Output real-time point cloud data in high-precision



- High-speed scanning with 3m/s speed max



Specifications

CE RoHS

Model	Near FOV	Far FOV	Clearance distance (CD)	Measurement range (MR)	Detection accuracy	Inspection speed	Scan frame rate	Label
MV-DL1617-05L /Metrological certification set	1000 mm	2235 mm	750 mm	1000 mm	± 5 mm	1.5m/s@±5mm Accuracy	600Hz@1m³ MR	A
MV-DL2125-03H-R	1000 mm	2600 mm	700 mm	1000 mm	± 5 mm	3 m/s @±5 mm Accuracy	600 fps @1 m³ measurement range	B
MV-DL2125-04H-H	1000 mm	2600 mm	700 mm	1000 mm	± 5 mm	3m/s@±5mm Accuracy	600 fps @1 m³ measurement range	B

Dimension

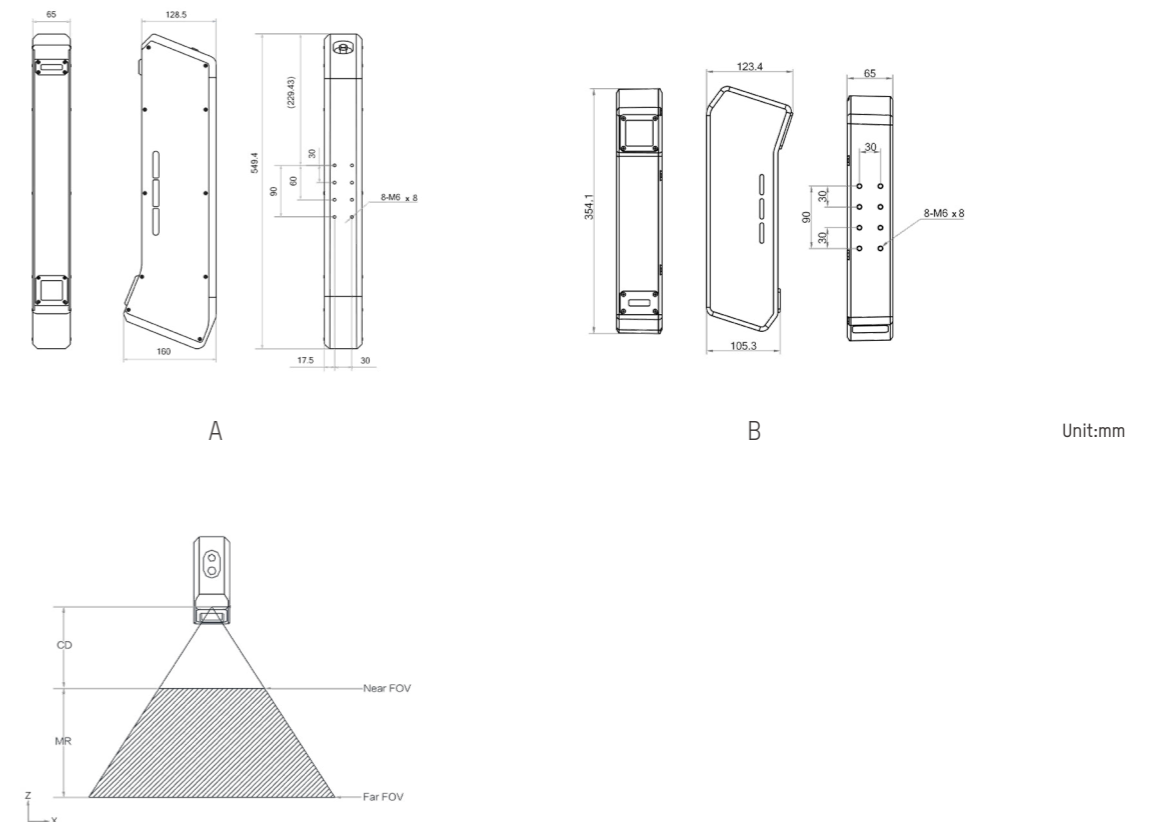

Unit:mm

Let us customize machine vision platforms to your needs

Contact us for brand new, refurbished or used Equipment

RGB-D smart 3D camera

By virtue of active binocular stereo imaging technology and in conjunction with color cameras, it can output RGB-D images at high frame rate. With the built-in AI algorithms, multiple tasks can be completed within the camera. It can be used as the vision core for applications such as singulation system, robotic parcel-feeding system, and depalletizing & palletizing system.

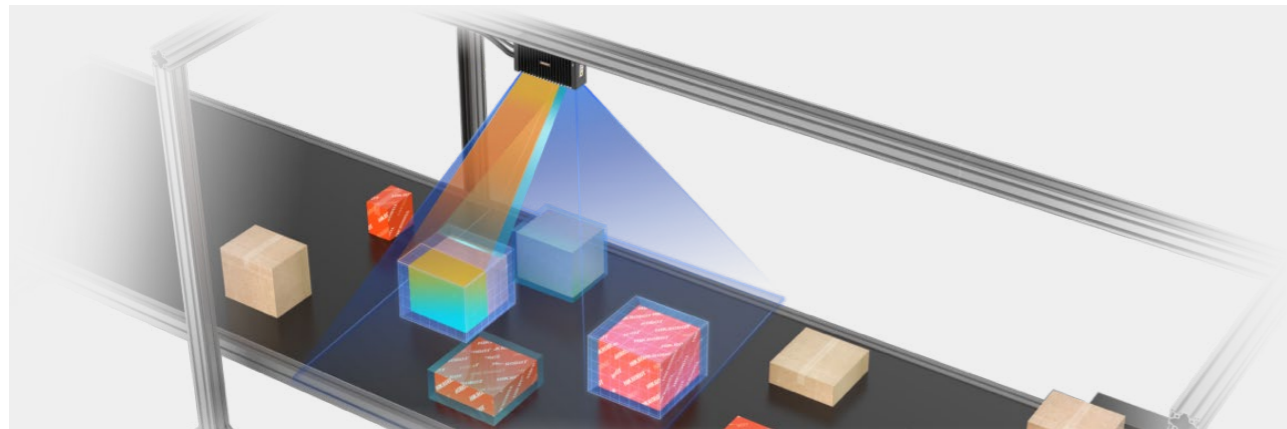

- One device with image and data integrated

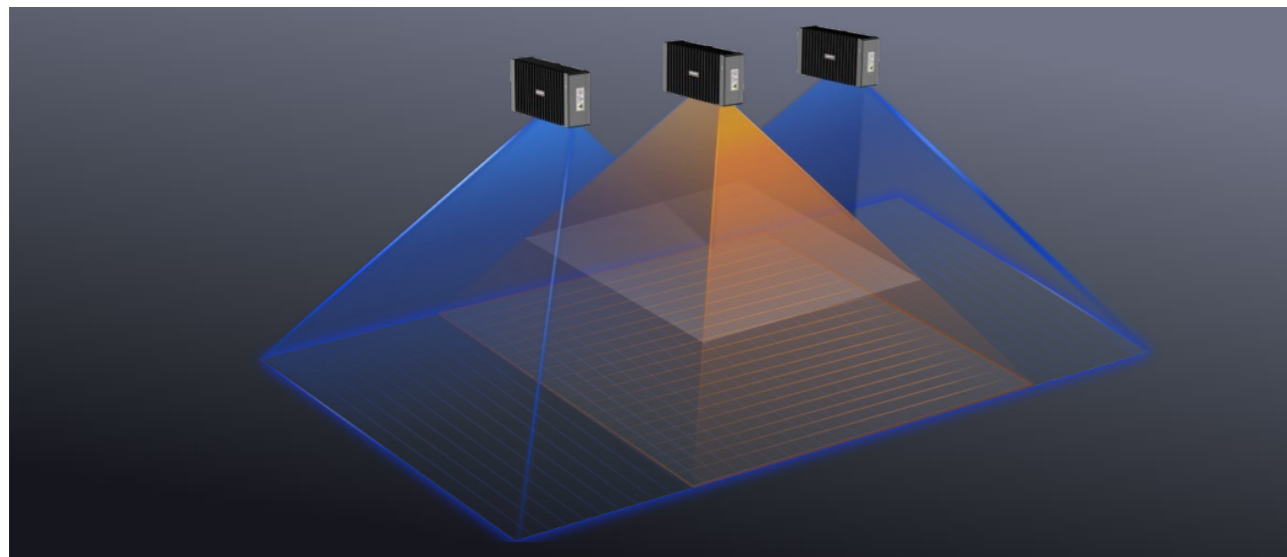

- One-click calibration and user-friendly deployment

Let us customize machine vision platforms to your needs

Specifications

CE RoHS

Model	Near FOV	Far FOV	Clearance distance (CD)	Measurement range (MR)	Accuracy (Depth Image)	Accuracy (RGB Image)	Output Frame Rate	Data Format
MV-DB500S	580 mm × 470 mm	2400 mm × 1800 mm	500 mm	1500 mm	XY:5 mm@1 m; 10 mm@2 m Z:5 mm@1 m; 10 mm@2 m	XY:2.6 mm@1 m; 5.5 mm@2 m	RGB-Depth sync output 18fps@1408×1024 30fps@704×512	Original image (mono and color images), correction image (left and right), depth image
MV-DB500S-C	580 mm × 470 mm	2400 mm × 1800 mm	500 mm	1500 mm	XY:5 mm@1 m; 10 mm@2 m Z:5 mm@1 m; 10 mm@2 m	XY:2.6 mm@1 m; 5.5 mm@2 m	7 fps@EDP Mode	Original image (mono and color images), depth image, RGB-D image, EDP detection result
MV-DB500S-S	580 mm × 470 mm	2400 mm × 1800 mm	500 mm	1500 mm	XY:5 mm@1 m; 10 mm@2 m Z:5 mm@1 m; 10 mm@2 m	XY:2.6 mm@1 m; 5.5 mm@2 m	30 fps@ Singulation Mode	Original image (mono and color images), depth image, RGB-D image, package posture information
MV-DB500S-R	580 mm × 470 mm	2400 mm × 1800 mm	500 mm	1500 mm	XY:5 mm@1 m; 10 mm@2 m Z:5 mm@1 m; 10 mm@2 m	XY:2.6 mm@1 m; 5.5 mm@2 m	8 fps@Grasp Mode Support HDR	Original image (mono and color images), depth image, RGB-D image, package grasping point information, instance segmentation image
MV-DB500S-V	580 mm × 470 mm	2400 mm × 1800 mm	500 mm	1500 mm	XY:5 mm@1 m; 10 mm@2 m Z:5 mm@1 m; 10 mm@2 m	XY:2.6 mm@1 m; 5.5 mm@2 m	8fps@ Measuring mode	Original image (mono and color images), depth image, volume data

Dimension

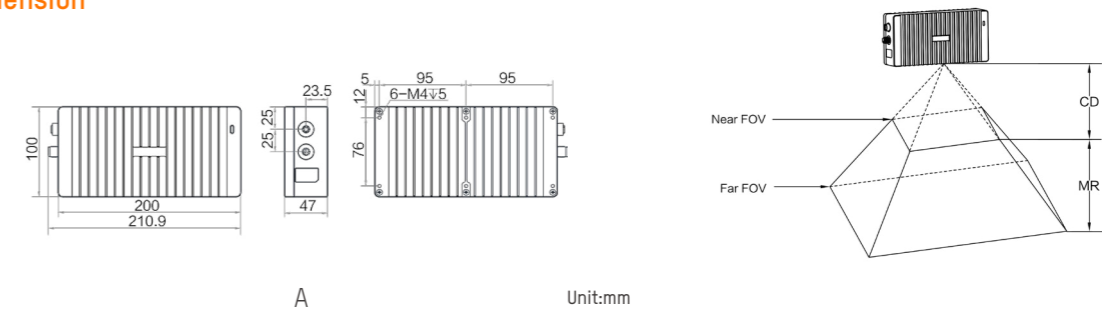

Contact us for brand new, refurbished or used Equipment

3DMVS Client

Product Background

Stereo Camera Client Software and Software Development Kit is a software application developed specifically for Hikrobot stereo cameras, which is applicable to line laser stereo cameras, RGB-D stereo cameras and other products. The client supports real-time preview, parameter configuration, calibration, data saving, firmware upgrade and other functions. Preview image types are available as raw, depth, contour and point cloud maps.

Key Features

- Simple installation, no need to install other drivers to operate and use.
- A variety of sample programs, source code and development documentation to make it easy for users to get started quickly.
- Rich API interface for fast and effective secondary development.
- Support preview of different types of images, including original, depth, point cloud, and contour maps.
- User-friendly interaction design, easy to operate and intuitive functions.
- Support multi-platform operation, compatible with Windows 7/10 32/64-bit OS.

3DMVS

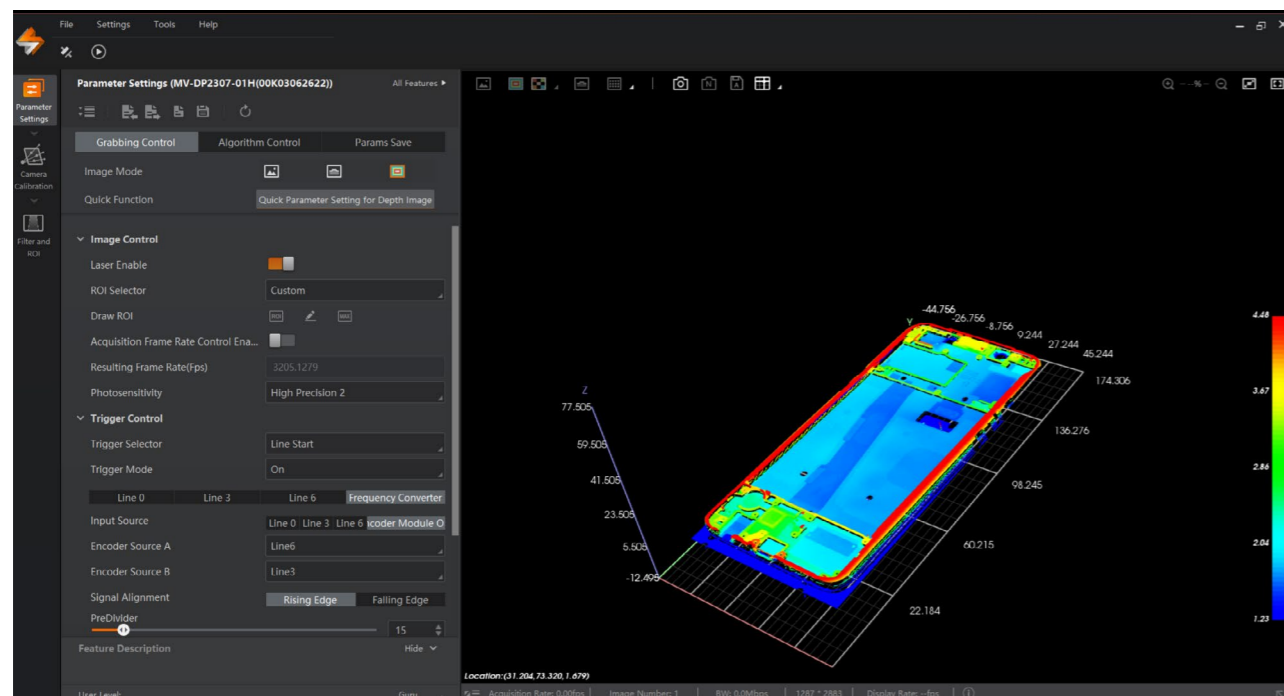

Contact us for brand new, refurbished or used Equipment



AGS-TECH Inc.

Phone: +1-505-550-6501 and +1-505-565-5102

Fax: +1-505-814-5778

Email: sales@agstech.net

Web: <http://www.agstech.net>

Let us customize machine vision platforms to your needs

Vision Controller

VB2000 Series Vision Controller

VB2000 series vision controller is a central processing device for integrated control and processing of machine vision, provides comprehensive interfaces for machine vision system control and data transaction which is also adoptable for normal vision system components.

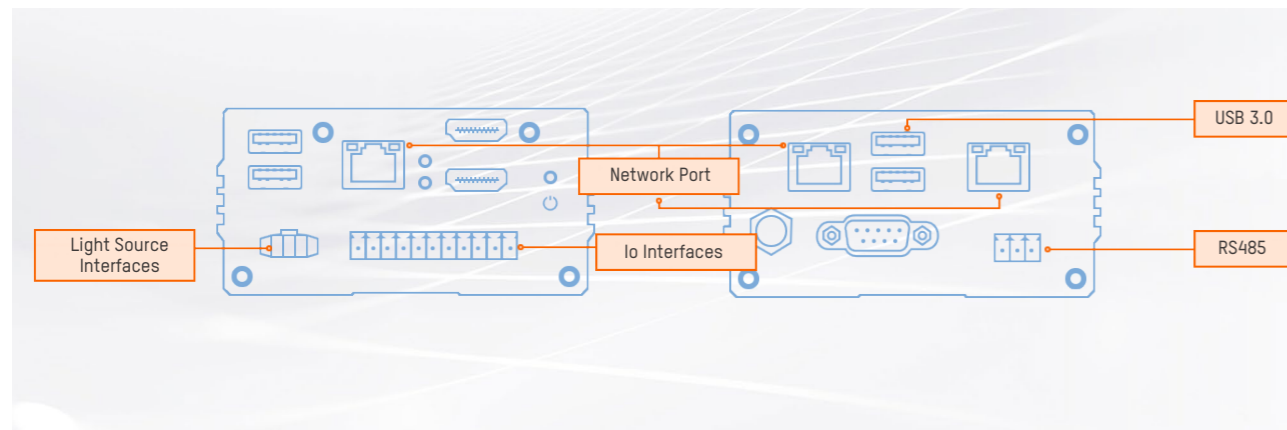

- Highly integrated, Rich interfaces

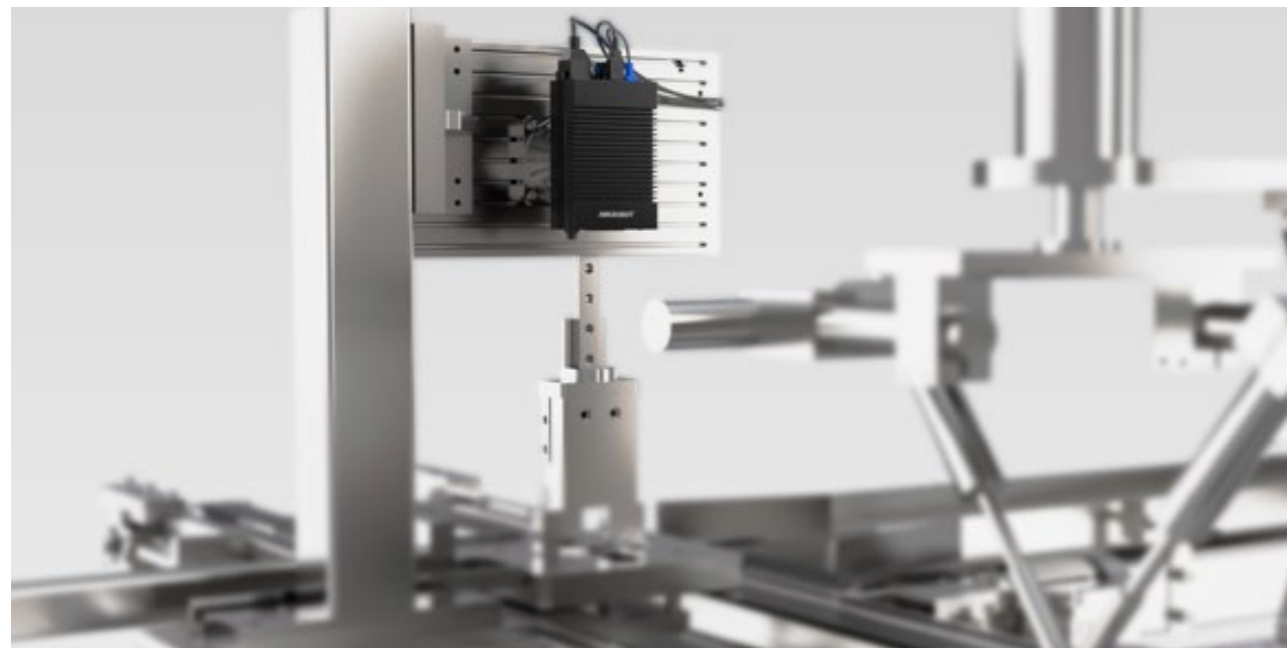

- Compact and Easy Set-up

Let us customize machine vision platforms to your needs

Specifications



Model	CPU	Memory	Storage	Digital I/O	Light Interface	GigE	USB3.0	USB2.0(+built-in)
MV-VB2210-1206	Intel® Atom™ E3845	4 GB	128 GB SSD	Opto-isolated input × 4, opto-isolated output × 4	1	3	1	3 + 1
MV-VB2220-1206	Intel® Atom™ E3845	4 GB	128 GB SSD	Opto-isolated input × 4, opto-isolated output × 4	1	3	1	3 + 1

Dimension

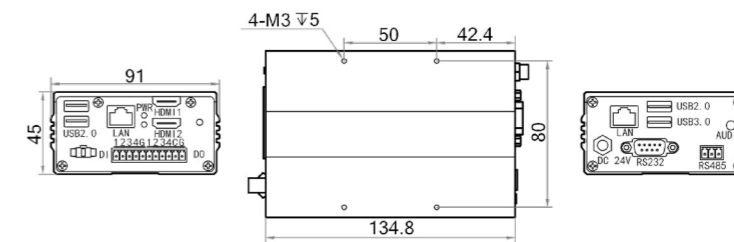

Unit:mm

Accessories



Power Supply	Power Adapter	Mounting Bracket	Model
Model	MV-ACC-03-4201	Standard	V901-Mounting plate

Contact us for brand new, refurbished or used Equipment

VC2000 Series Vision Controller

VC2000 series vision controller is equipped with Intel high-performance processing chip and rich data acquisition and control interfaces, including gigabit network port, IO, light source, serial port, etc; The whole machine is compact in structure and excellent in performance, providing a complete solution for simple visual applications of multiple cameras.

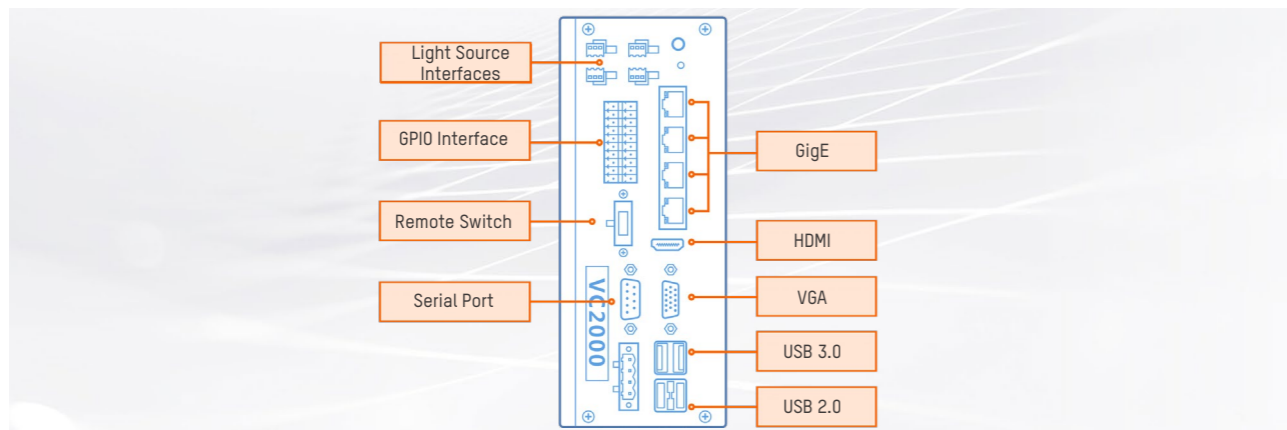

• Rich interface and simple application



• Compact and convenient installation

Specifications



Model	CPU	Memory	Storage	Digital I/O	Light Interface	GigE	USB3.0	USB2.0(+built-in)
MV-VC2040-128G40-NN	Intel® J6412	8GB	128GB SSD	Opto-isolated input × 8, opto-isolated output × 8	4	4	2	2 + 1
MV-VC2040-128G40-1T	Intel® J6412	8GB	128GB SSD+ 1T HDD	Opto-isolated input × 8, opto-isolated output × 8	4	4	2	2 + 1

Dimension

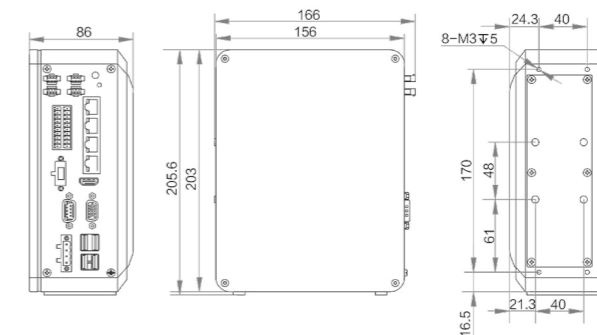

Unit:mm

Accessories



Power Supply	Power Adapter
Model	KPE150M-VI

Terminal Head	Power Supply Terminal	Remote Switch Terminal
2pin	HW0250520000G	--
4pin	HW0450520000G	power cable(SR4A01433)

Mounting Component	Rail Hanging
Accessories Package	V-Controller 004-Rail Hanging

Let us customize machine vision platforms to your needs

Contact us for brand new, refurbished or used Equipment

VC3000 Series Vision Controller

VC3000 vision controller is a new generation of IPC for visual inspection, which is characterized with the flagship computing power and comprehensive control/data interface. It has desirable compatibility with machine vision components in common tasks such as positioning, inspection, measurement and recognition.



- Well-designed machine structure



- Flexible installation

Specifications



Model	CPU	Memory	Storage	Digital I/O	GigE	USB3.0	USB2.0 (+built-in)
MV-VC3101P-128G60	Intel® Celeron™ G4900	8 GB	128 G SSD	Opto-isolated input × 3, Opto-isolated output × 8	6	4	4 + 1
MV-VC3102P-128G60	Intel® Celeron™ G4900	8 GB	128 G SSD + 2T HDD	Opto-isolated input × 3, Opto-isolated output × 8	6	4	4 + 1
MV-VC3201P-128G60	Intel® Pentium™ G5400	8 GB	128 G SSD	Opto-isolated input × 3, Opto-isolated output × 8	6	4	4 + 1
MV-VC3202P-128G60	Intel® Pentium™ G5400	8 GB	128 G SSD + 2T HDD	Opto-isolated input × 3, Opto-isolated output × 8	6	4	4 + 1
MV-VC3301P-128G60	Intel® Core™ i3-8100	8 GB	128 G SSD	Opto-isolated input × 3, Opto-isolated output × 8	6	4	4 + 1
MV-VC3302P-128G60	Intel® Core™ i3-8100	8 GB	128 G SSD + 2T HDD	Opto-isolated input × 3, Opto-isolated output × 8	6	4	4 + 1

Model	CPU	Memory	Storage	Digital I/O	GigE	USB3.0	USB2.0 (+built-in)
MV-VC3303P-128G60	Intel® Core™ i3-8100	8 GB	128 G SSD + 2T HDD	Opto-isolated input × 3, Opto-isolated output × 8	6	2 + 4(PoE)	4 + 1
MV-VC3304P-128G60	Intel® Core™ i3-8100	16 GB	128 G SSD + 2T HDD	Opto-isolated input × 3, Opto-isolated output × 8	6	4	4 + 1
MV-VC3501P-128G60	Intel® Core™ i5-8500	8 GB	128 G SSD	Opto-isolated input × 3, Opto-isolated output × 8	6	4	4 + 1
MV-VC3502P-128G60	Intel® Core™ i5-8500	8 GB	128 G SSD + 2T HDD	Opto-isolated input × 3, Opto-isolated output × 8	6	4	4 + 1
MV-VC3503P-128G60	Intel® Core™ i5-8500	8 GB	128 G SSD + 2T HDD	Opto-isolated input × 3, Opto-isolated output × 8	6	2 + 4(PoE)	4 + 1
MV-VC3504P-128G60	Intel® Core™ i5-8500	16 GB	128 G SSD + 2T HDD	Opto-isolated input × 3, Opto-isolated output × 8	6	4	4 + 1
MV-VC3701P-128G60	Intel® Core™ i7-8700	8 GB	128 G SSD	Opto-isolated input × 3, Opto-isolated output × 8	6	4	4 + 1
MV-VC3702P-128G60	Intel® Core™ i7-8700	8 GB	128 G SSD + 2T HDD	Opto-isolated input × 3, Opto-isolated output × 8	6	4	4 + 1
MV-VC3703P-128G60	Intel® Core™ i7-8700	8 GB	128 G SSD + 2T HDD	Opto-isolated input × 3, Opto-isolated output × 8	6	2 + 4(PoE)	4 + 1
MV-VC3704P-128G60	Intel® Core™ i7-8700	16 GB	128 G SSD + 2T HDD	Opto-isolated input × 3, Opto-isolated output × 8	6	4	4 + 1

Dimension

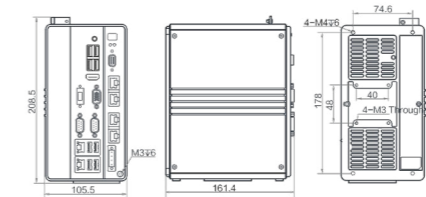

Unit:mm

Accessories



Power Supply	Host	Light Source Expansion Panel
Model	KPE150M-VI	KPL-060M-VI

Terminal Head	Power Supply Terminal	Remote Switch Terminal
2pin	HW02505200006	--
4pin	HW04505200006	power cable(SR4A01433)



Expansion Panel	Serial Port	Light Source	IO
Model	MV-VC-SR004	MV-VC-LV004	MV-VC-I0008

Mounting Component	Vertical Position	Rail Hanging
Accessories Package	V-Controller 004-Vertical Position	V-Controller 004-Rail Hanging

VM Algorithm development platform

Algorithm development platform is a machine vision software independently developed by Hikrobot, which is dedicated to providing customers with algorithm tools to quickly solve vision applications, and can meet machine vision applications such as visual positioning, size measurement, defect detection and information recognition.

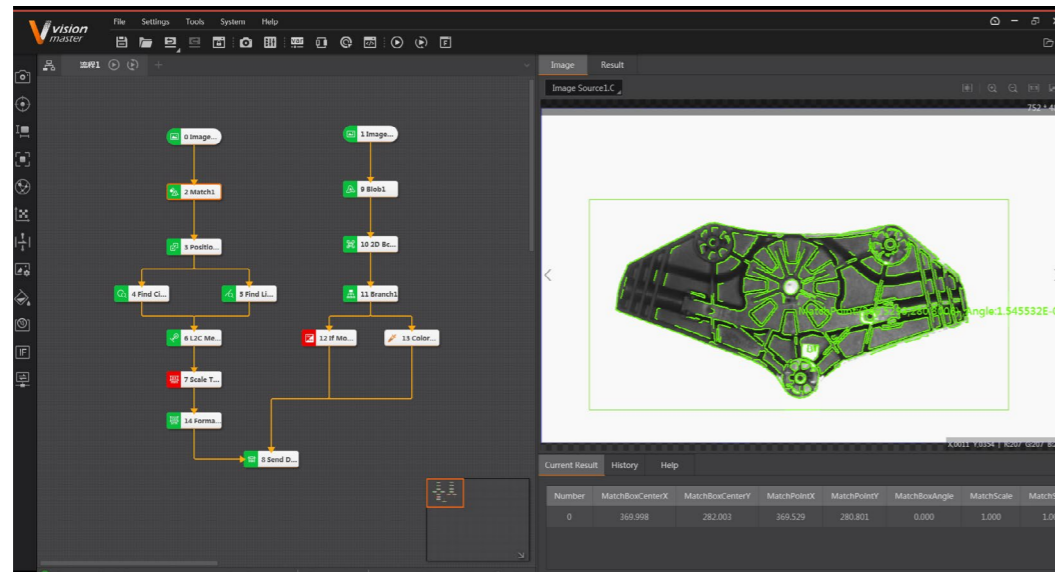

Key Features

- It consists of nearly a thousand completely self-developed image processing operators and a variety of interactive development tools, including 140 + module tools, supporting a variety of operating systems and image acquisition hardware devices, which can meet the needs of positioning, measurement, identification and detection in the field of machine vision applications.
- Fully graphical interactive interface, function icons are intuitive and easy to understand. Dragging operation can quickly set up visual scheme. Module operation status is independently identified and displayed in real time.
- Users can create visual solutions according to their needs, customize the running interface, and integrate background images or company logos on the running interface to meet the personalized needs of customers.
- Compatible with GigE Vision and USB3 Vision protocol standards, allowing access to multiple camera brands. Support local image and camera real-time image processing.
- The secondary development is simple and easy to use. The simplified interface can save 90% of the code. The new tool can be imported into Visual Studio with one key. It supports the interface development of QT, MFC, WPF and WinForm.
- Support the development of user-defined modules. Users can directly drag and use the user-defined algorithm after it is packaged as a VM module.
- Support TCP/IP, ModBus, serial port, UDP, Ethernet/IP and other common industrial communication protocols, compatible with the communication of mainstream PLC models.

Locating and measuring tools

Accurately and efficiently locate any geometric element in the image with 1/16 pixel accuracy.

- Efficient template matching tool to overcome differences in sample translation, rotation, scaling, and illumination.
- Quickly and accurately find the position of circles, lines, blobs, edges, vertices, and other geometric objects.
- Accurately measure shapes, dimensions, areas, distances, angles, intersections, and other geometric properties.
- It can be used in robot guidance and other vision tools to provide position information and presence information.

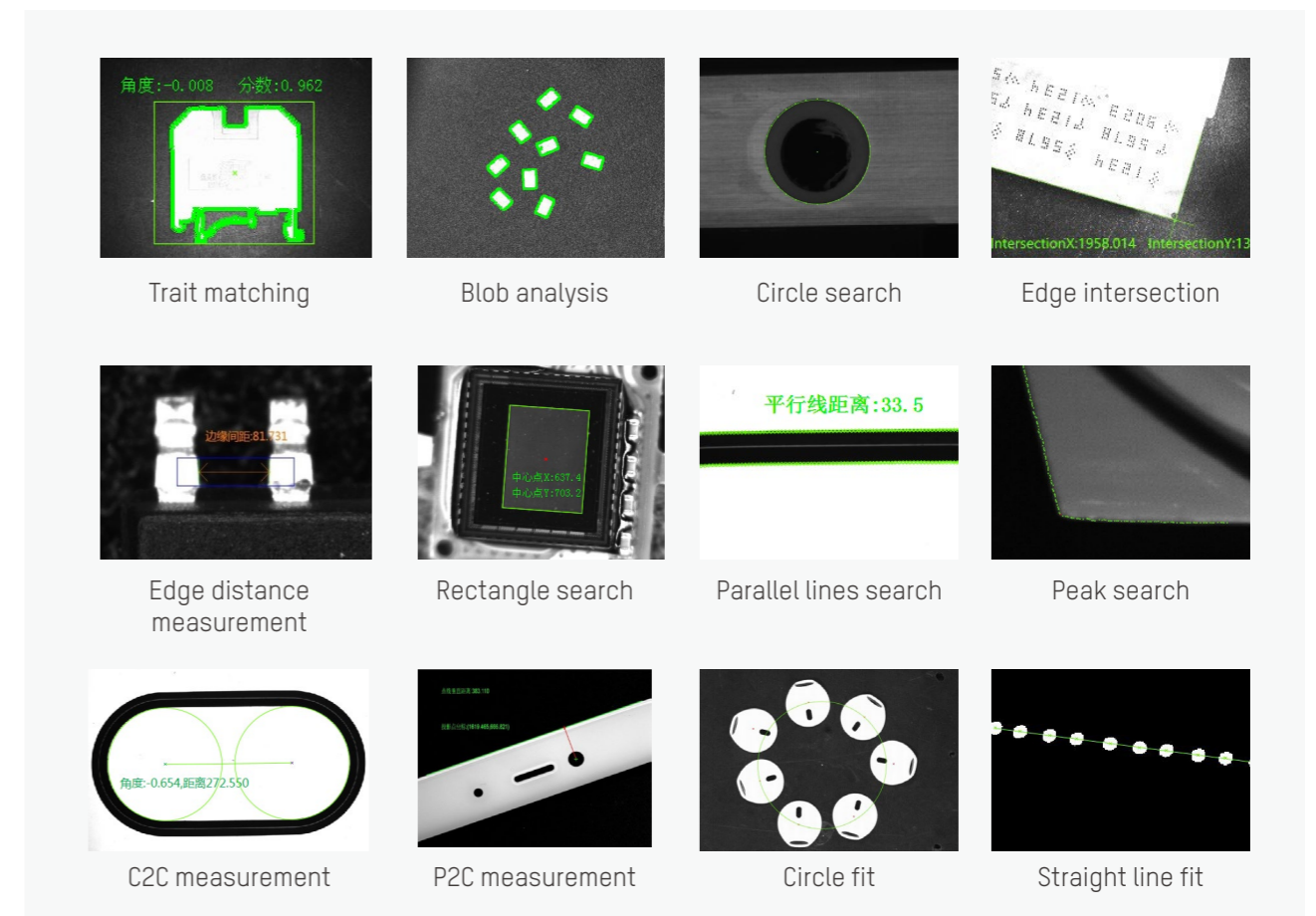

Identification tools

- Fast and accurate reading of digital information code.
- OCR algorithm based on deep learning can adapt to the recognition of complex background, low contrast, deformation and other characters.
- One-dimensional code and two-dimensional code of various types can be identified with different positions, angles and illumination. The influence of image distortion can be effectively overcome.
- Provides continuous, accurate, high-speed reading of ID information for part tracking.
- Support multiple VeriCode accurate identification in case of strong interference.
- It supports CPU and GPU versions of deep learning code reading algorithm, and also carries out accurate positioning and recognition in complex background.



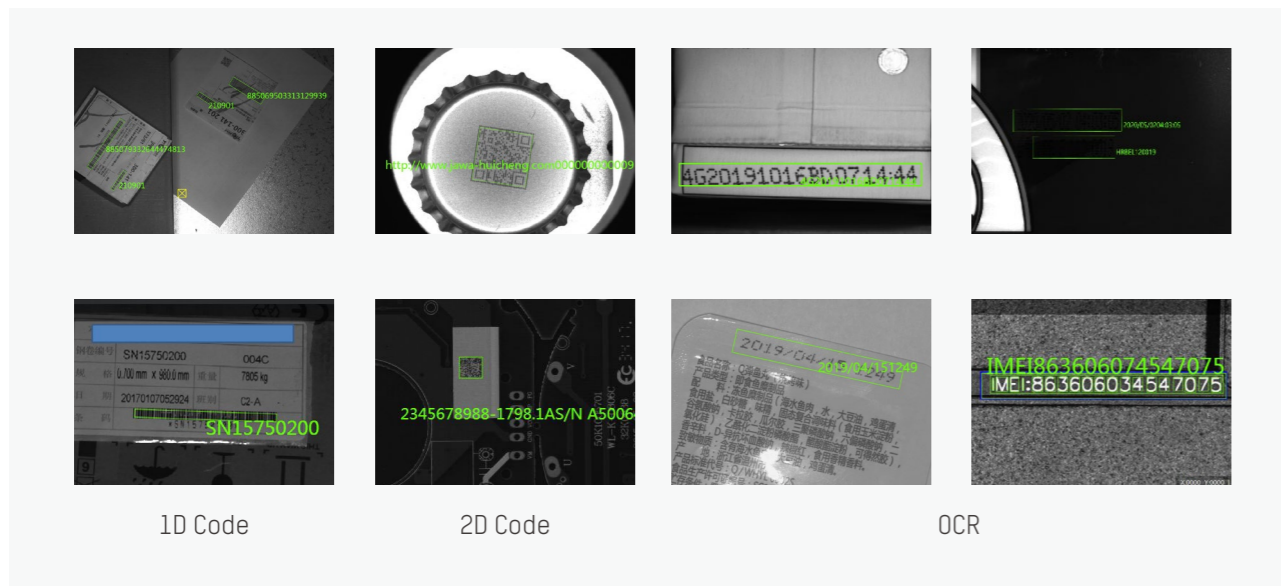

Defect detection tool

Accurately identify defects on the surface, shape and contour of the workpiece.

- Based on deep learning technology, it can detect fine surface scratches and spots, and overcome the interference of surface texture, color and noise.
- Accurate detection of workpiece shape and contour defects, can overcome the interference of burrs, color, noise.
- Reliable tool for comparing standard parts to locate small differences in workpiece.

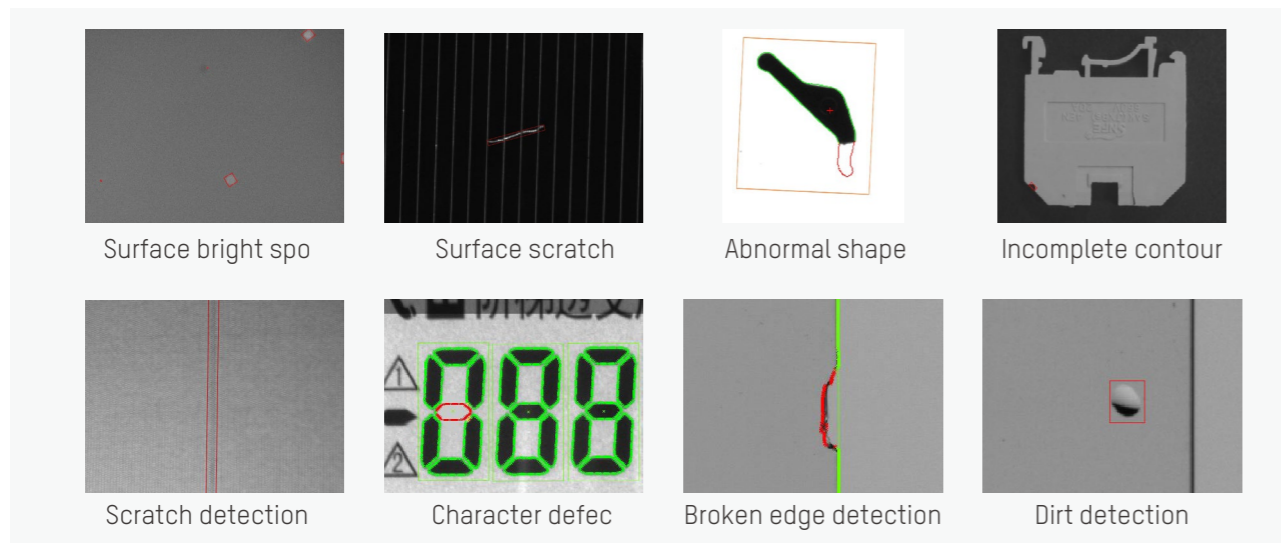

List of algorithm platform tools

Toolbox	Enumeration Of Tools
Acquisition (5)	Image Source, Multi-Image Acquisition, Image Output, Image Buffer, Light Source
Locating (27)	Contour Match, High-Precision Match, Fast Match, Gray Model Match, Mark Locating, Position Fixture, Blbo Analysis, Blob Label Analysis, Circle Search, Ellipse Find, Matrix Circle Find, Line Search, Line Search Group, Multi-Line Search, Edge Intersection, Quadrilateral Search, Parallel Line Search, Calculate Parallel Line, Rectangle Search, Find Median Line, Find Vertical Line, Caliper, Edge Search, Peak Search, Position Fixture, Target Tracking
Image Generation (3)	Circle Fit, Line Fit, Geometry Generation

Toolbox	Enumeration Of Tools
Measurement (10)	Line-to-Circle Measurement, Circle-to-Circle Measurement, Point-to-Circle Measurement, Point-to-Line Measurement, Line-to-Line Measurement, Point-To-Point Measurement, Intensity Measurement, Edge Distance Measurement, Pixel Count, Histogram
Recognition (12)	BcR, 2D BcR, OCR, DL Character Recognition G/C, DL Code Reading G/C, DL Character Locating G/C, DL Single Character Detection G/C, ML Classifier
Calibration (9)	Calibration Board Calibration, Camera Mapping, N-point Calibration, Translation Calibration, Distortion Calibration, Mapping Calibration, N-image Calibration, Load Calibration, Rotate Calibration
Deep Learning (16)	DL Image Segmentation G/C, DL Classification G/C, DL Object Detection G/C, DL Image Retrieval G/C, DL Anomaly Detection G/C, DL Instance Segmentation G/C, DL Unsupervised Segmentation G, Quick Image Segment, DL Register Classify G/C
Calculation (11)	Single Point Alignment, Single Point Grab, Single Point Map Alignment, Single Point Rectify, Calibration Transformation, Point Set Alignment, Rotation Calculate, Line Alignment, Scale Transformation, Variable Calculation, Coordinate Transform
Image Processing (21)	Image Processing Combination, Image Morphology, Image Binarization, Image Filtering, Image Enhancement, Distortion Correction, Image Computing, Image Clarity Estimation, Image Fixture, Shading Correction, Image Resize, Affine Transformation, Ring Expansion, Copy Fill, Frame Mean, Normalization, Image Correction, Geometric Transformation, Image Stitching, Multi-image Fusion, Normalization
Split Combination (6)	Divide Image, 2D Array Correct, Label Filter, Box Merge, Box Overlap, Box Filter
Color Processing (4)	Color Extraction, Color Measurement, Color Transformation, Color Recognition,
Defect Detection (13)	OCV, Surface Defect Filter, Arc Edge Defect Detection, Line Edge Defect Detection, Arc-pair Defects Detection, Line-pair Defects Detection, Edge Combination Defect Detection And Edge-pair Combination Defect Detection Respectively, Edge Model Defect Detection, Edge-pair Model Defect Detection, Anomaly Detection, Edge Position Trend Analysis, Edge Pair Position Trend Analysis
Logic Tools (15)	Condition Branch, Condition Detection, Branch, Branch String, Save Text, Logic, Format, String Comparison, Shell, Group, Point Set, Time-consuming Statistics, Data Set, Trigger Module, Graphics Collection
Communication (5)	Receive Data, Send Data, Camera IO (Support TCP/IP, Modbus, UDP, Serial Port, Ethernet/IP And Other Common Industrial Protocols; Support Communication With Mainstream Brand PLC), Protocol Analysis, Protocol Assembly

Classic Application

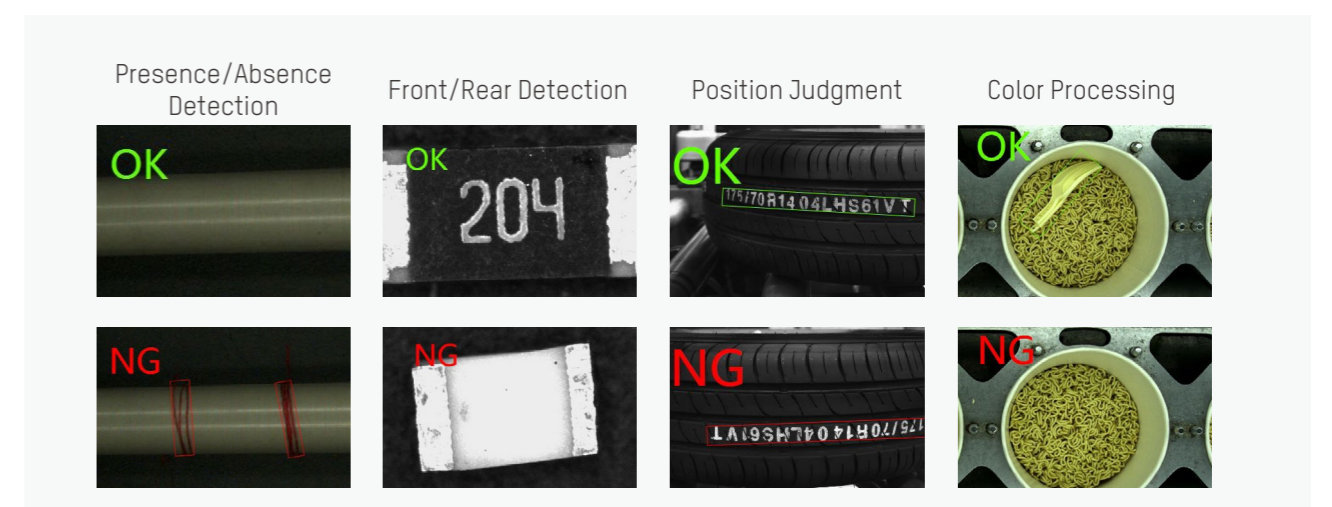

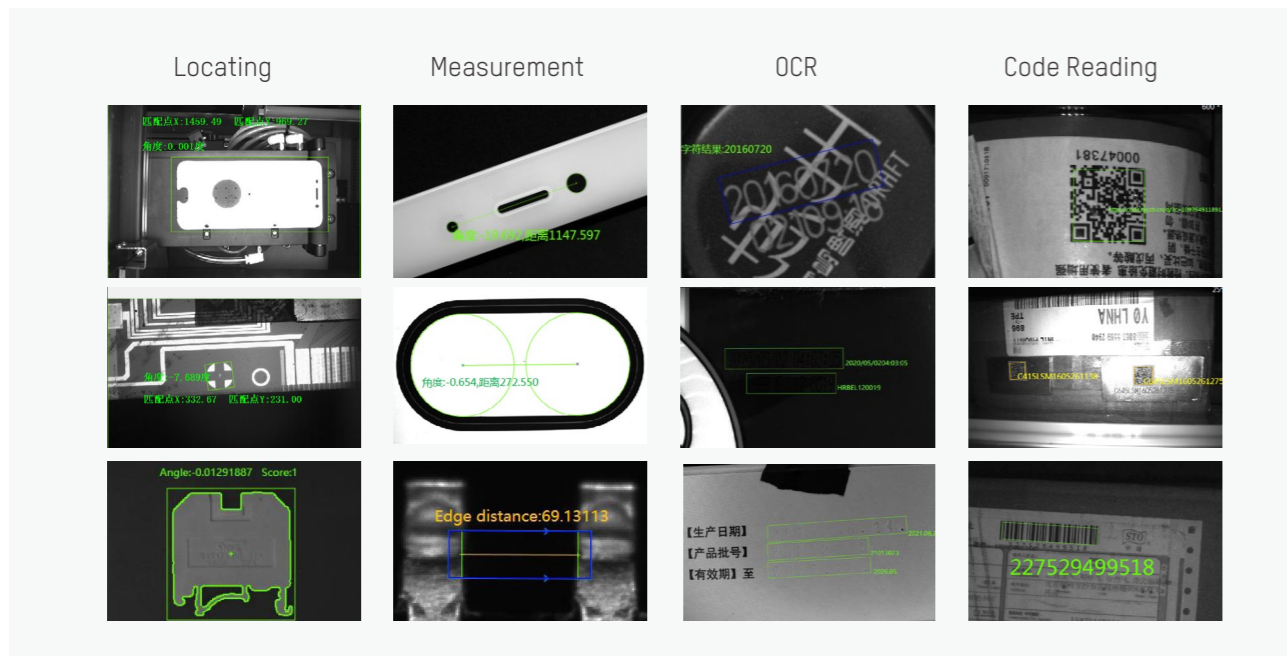

Applicable Industries



Application Case

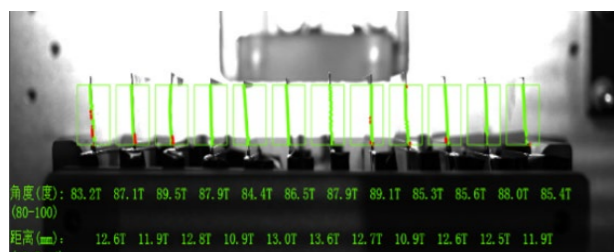

Li-ion battery lug measurement: Use the positioning and measurement module to measure the data related to Li-ion battery lugs, and design the software interface through secondary development.

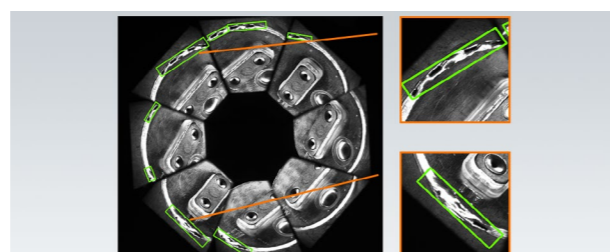

Lithium battery sealing welding defect detection: using deep learning algorithms for lithium battery sealing welding defect detection, can effectively detect welding defects such as welding offset, welding penetration, welding disconnection.

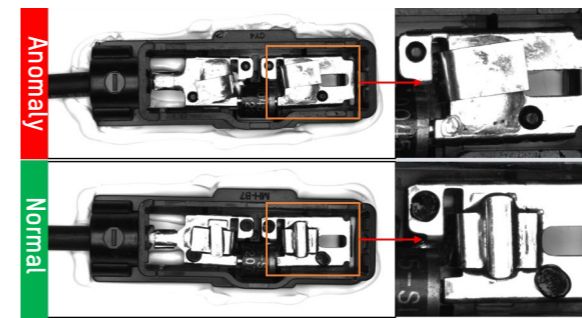

PV module junction box welding scar detection: using deep learning with traditional detection algorithms to detect PV module junction box welding scars.

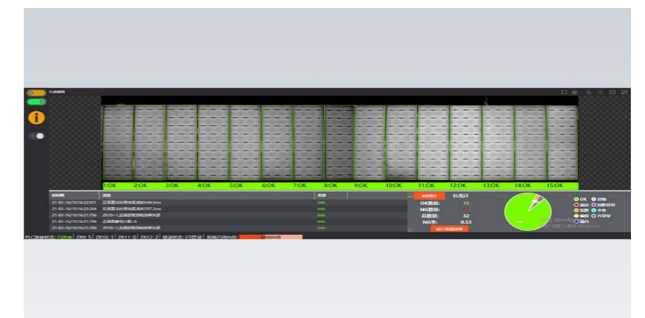

PV panel defect detection: using deep learning with traditional algorithms for defect detection during EL inspection of PV panels.

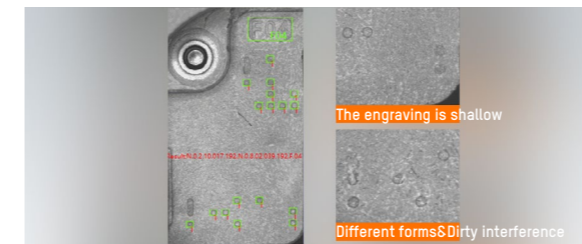

Consumer electronics industry 8421 code reading: using deep learning algorithms to extract the smallest unit of 8421 code from the complex environment, with the script module to decode it.

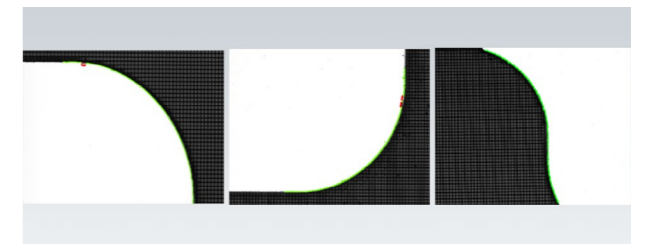

Cell phone screen edge defect detection: the use of traditional defect detection module to achieve the detection of defects on the edge of the cell phone screen.

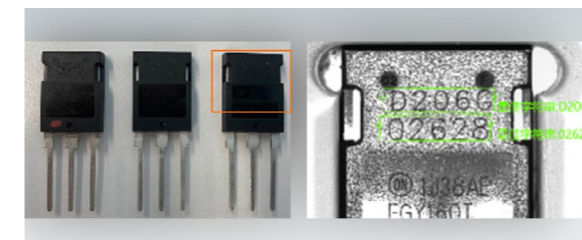

OCR recognition of electronic components: using deep learning algorithms to cope with OCR recognition of low contrast and complex backgrounds on electronic components

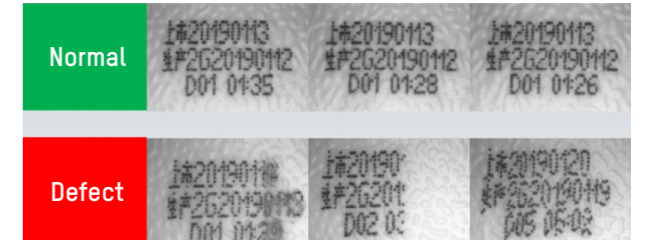

Food packaging character defect detection: using deep learning algorithms to achieve defect detection of spray code characters on food packaging.

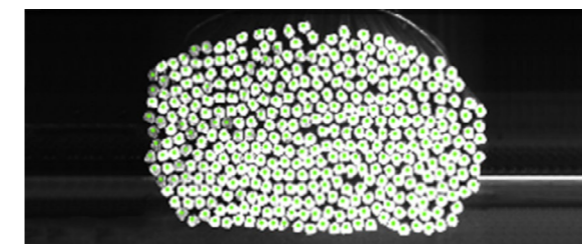

Rebar counting: Use deep learning algorithm to implement counting function when rebar is bundled.

CodePlatform

Hikrobot's CodePlatform is a comprehensive code-reading software platform, including data collection, image processing, communication output, data statistics and other functions. With strong compatibility and rich functions, the platform meets most demands of common code-reading application scenarios.

- **Multi-business scenarios:** Modular software design, high expansion, suitable for multi-business scenarios such as express logistics, pallet access door code reading, and on-site logistics workstations
- **Rich interface information:** Including real-time information area, picture display area, history record area, menu configuration area, running status display, quick function area, user rights management, etc., rich in information
- **Product access:** Can access all series cameras such as code reading cameras, volume cameras, panoramic industrial cameras, and support multi-camera combination applications
- **Convenient data connection:** Supports the upgrade of a separate protocol gateway plug-in, and supports highly customized business output

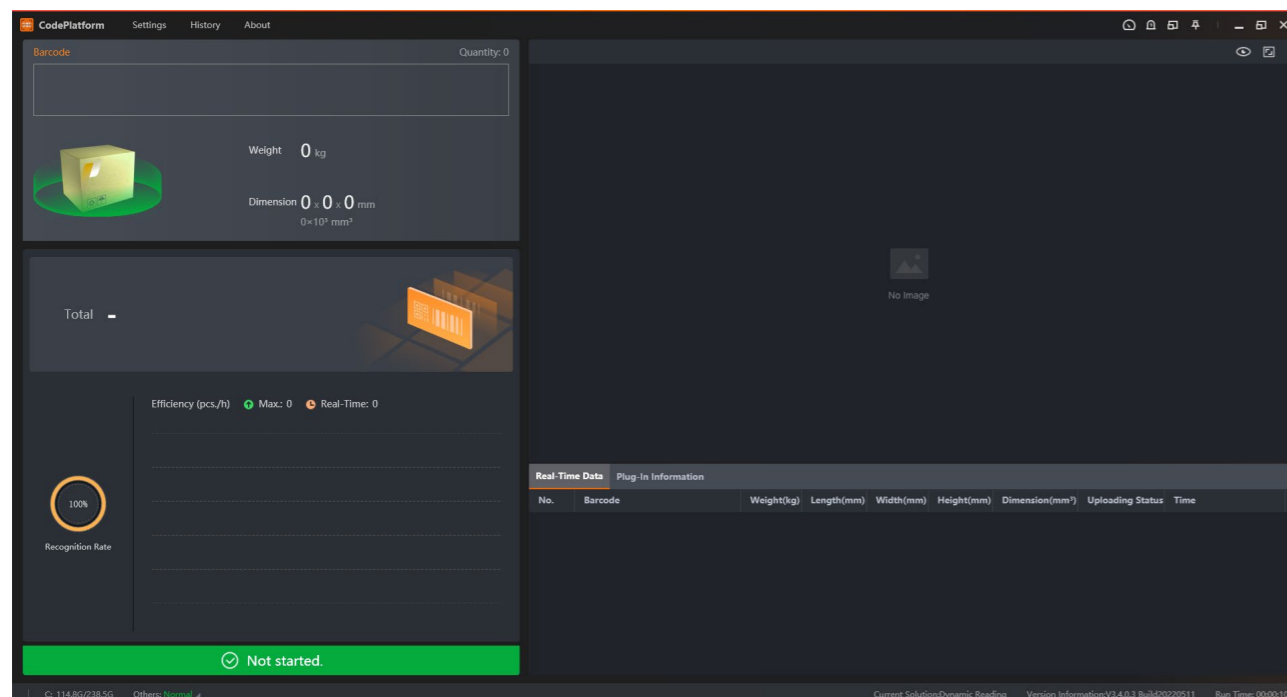

AGS-TECH Inc.
Phone: +1-505-550-6501 and +1-505-565-5102
Fax: +1-505-814-5778
Email: sales@agstech.net
Web: <http://www.agstech.net>

Let us customize machine vision platforms to your needs

Appendix

Pixel size

The size of 1 pixel, which is the smallest unit that makes up the image.

Sensor size

The diagonal size of the CMOS, the pixel size and the resolution together determine the size of the camera's sensor.

Resolution

Determine the accuracy of the image, in general, the higher the resolution of the image, the more pixels it contains, the clearer the image will be.

Frame rate

Number of frames per second transmitted, In fps units.

Line rate

The number of horizontal scans per second, in unit of Hz.

Reading speed

Number of codes read per second.

Focal length

Distance from the optical center of the lens to the imaging plane of the CMOS.

Working distance

Refers to the distance from the front of the lens to the surface of the subject, the lens can be clearly imaged at that distance.

FOV

Visible range of the camera.

DOF

The farthest and closest imaging distance at the front of the lens to obtain a clear image of the object being measured.

Acquisition frame rate

The number of images acquired by the device per unit of time.

Clear distance

The minimum distance between the measured object and the device when it is within the measurement range
If the distance between the measured object and the device is less than this value, valid data will not be obtained.

Measurement ranger

Depth range that can be measured by the device
If the measured object is not in the measuring range, valid data cannot be obtained.

Near FOV

The size of the field of view corresponding to the nearest end of the measurement range from the device.

Far FOV

The size of the field of view corresponding to the farthest end of the measurement range from the device.

Contact us for brand new, refurbished or used Equipment



AGS-TECH Inc.
Phone: +1-505-550-6501 and +1-505-565-5102
Fax: +1-505-814-5778
Email: sales@agstech.net
Web: <http://www.agstech.net>

Let us customize machine vision platforms to your needs