

AGS-TECH Inc

Phone: +1-505-550-6501 and +1-505-565-5102 Fax: +1-505-814-5778

Email: sales@agstech.net Web: http://www.agstech.net



### SOCKETS AND ACCESSORIES

### DIMENSION(mm)

**8PFA**

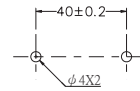
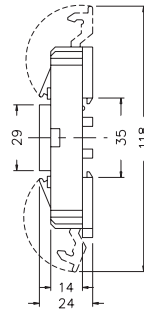
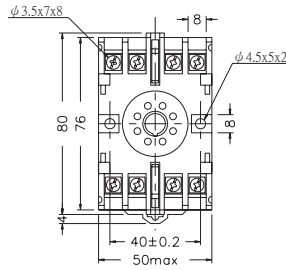

**PF085A**

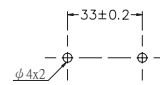
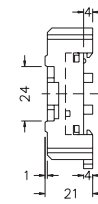
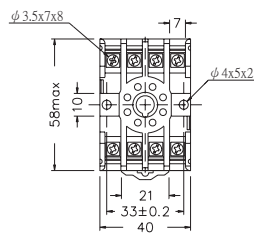

**PF083A**

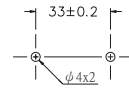
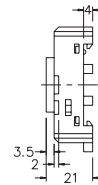
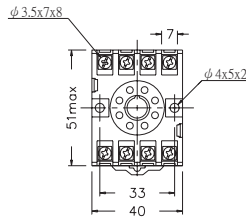

**PF083A-E**

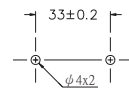
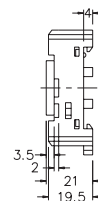
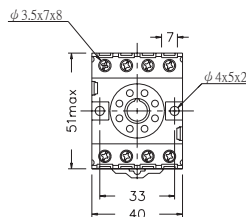

**P2CF-08**

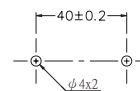
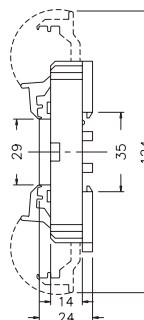
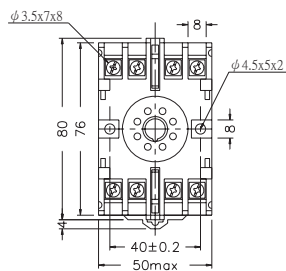

# DIMENSION(mm)

## PF113A

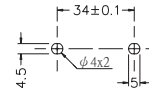
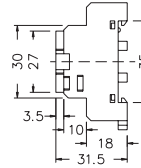
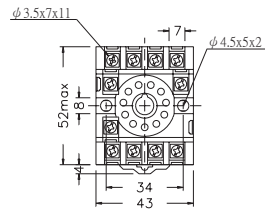

## PF113A-E

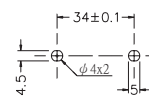
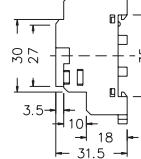
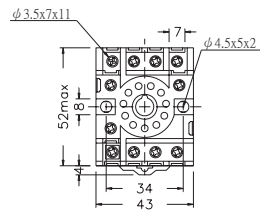

## P3G-08

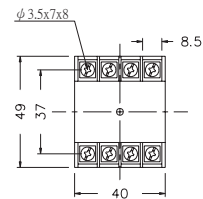
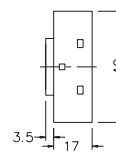
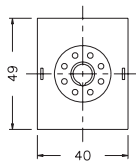

## US-08

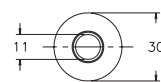
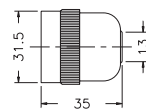
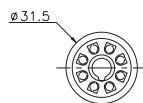

## PYF08A

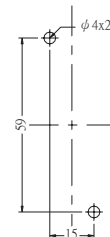
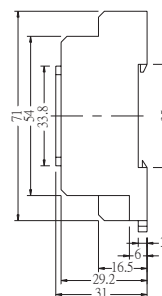
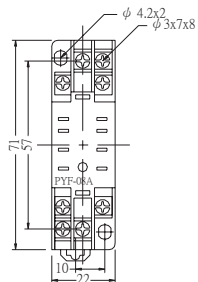

# DIMENSION(mm)

**PYF08A-E**

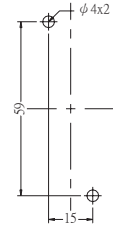
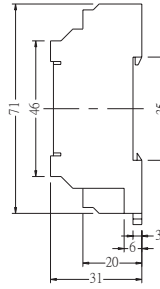
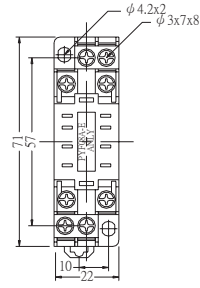

**PYF14A**

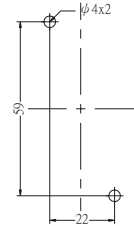
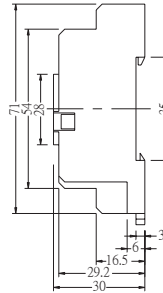
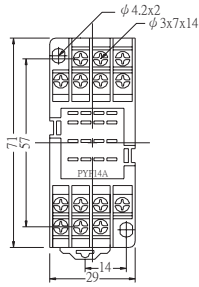

**PYF14A-E**

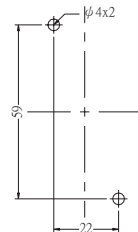
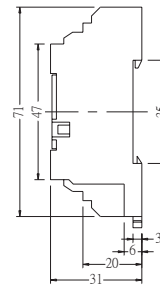
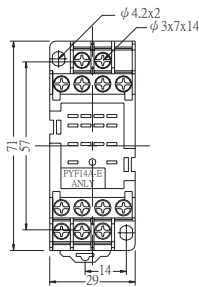

**PTF08A**

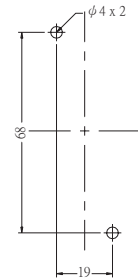
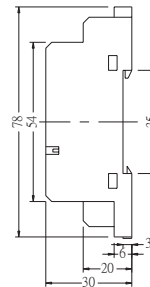
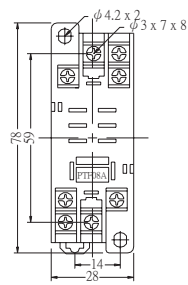

**PTF08A-E**

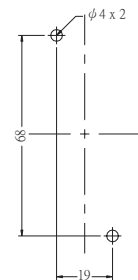
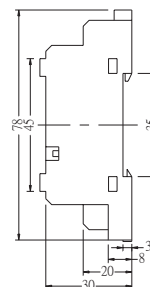
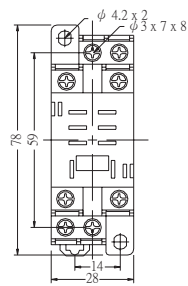

## DIMENSION(mm)

### APS-3

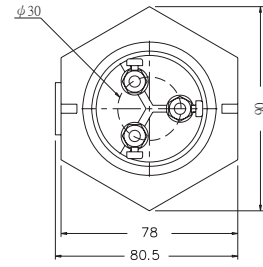
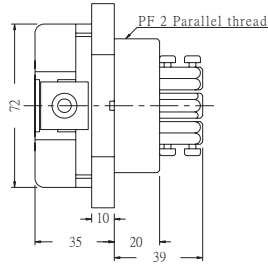

### PS-3S, PS-4S, PS-5S

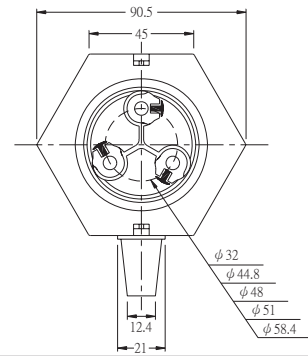
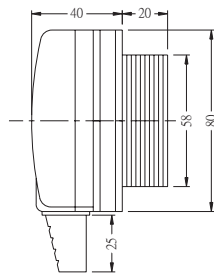

### AF-12

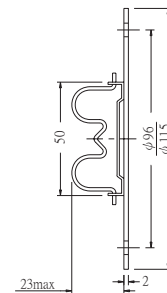
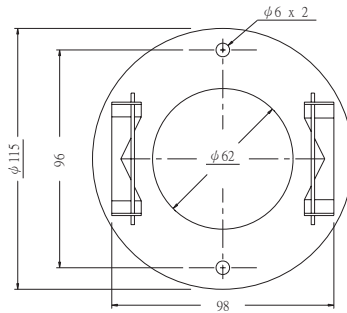

### STAINLESS

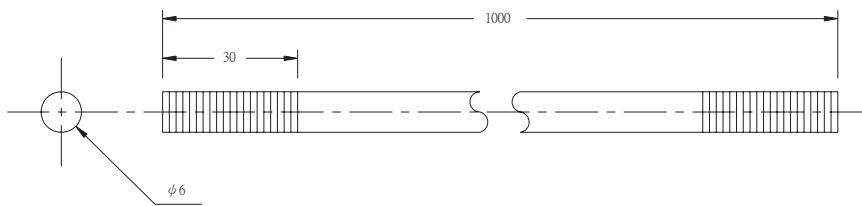

### SUSQ

### CONNECTING NUT

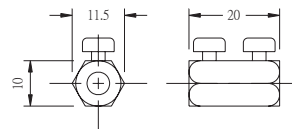
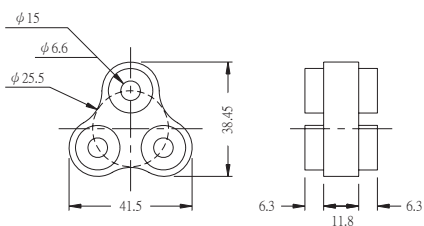

**DIMENSION(mm)**

**Y-20**

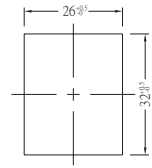
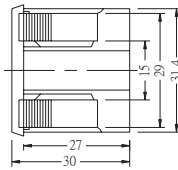
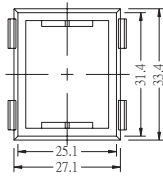

**Y-30**



$\phi 5.9$   
 $\phi 4.5$   
 $\phi 2.5$

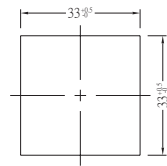
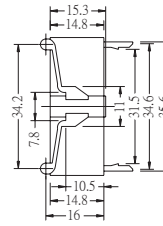
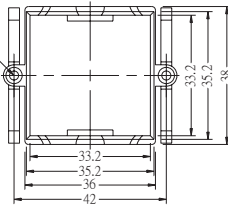

**Y-40**

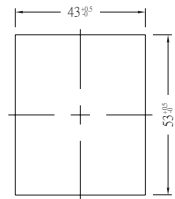
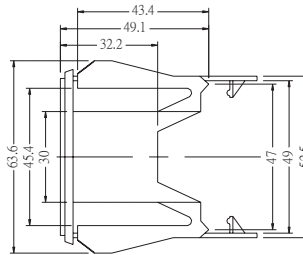
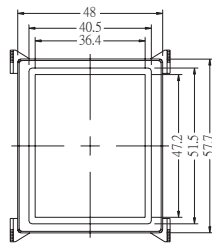

**Y-50**

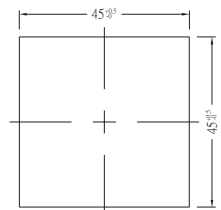
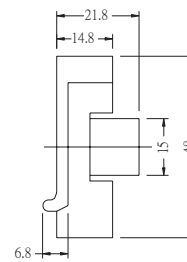
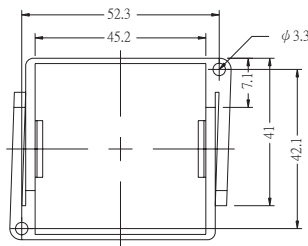
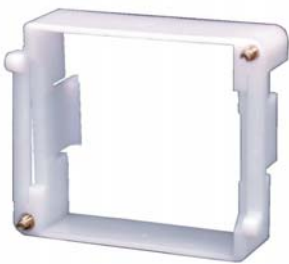

**Y-57**

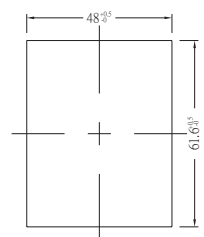
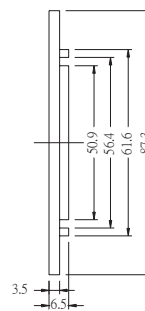
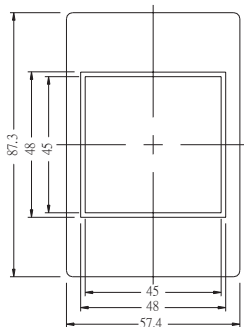

# DIMENSION(mm)

## Y-70

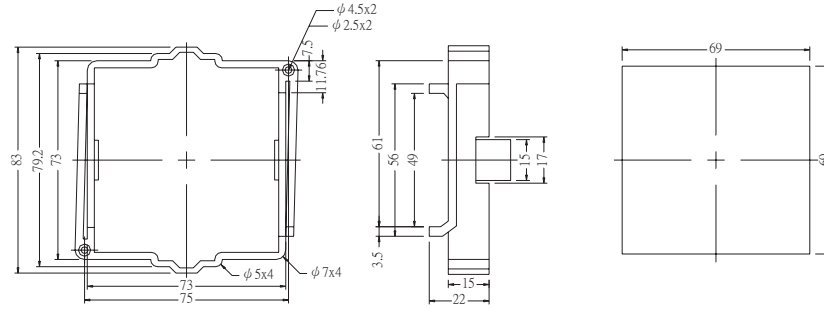

## DUST COVER - ASY SERIES

## DUST COVER - AH5 SERIES

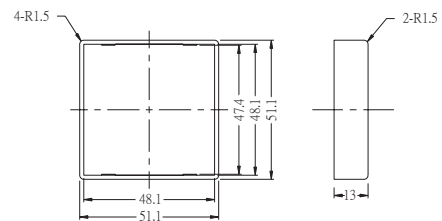
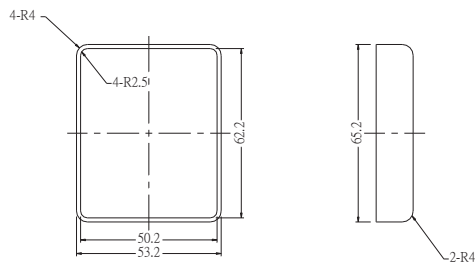

## AL-100

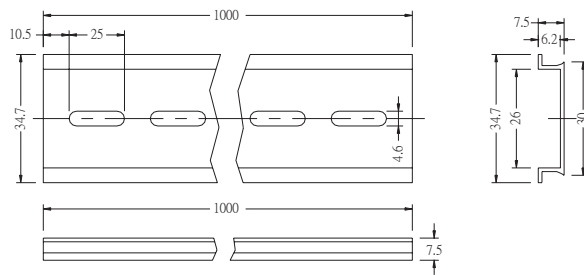

## FM-4

## FY-2

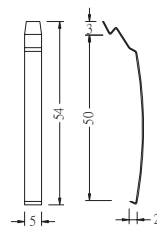
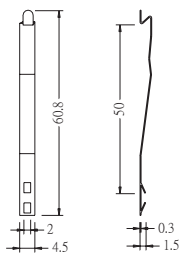

## FG-3

## FH-3

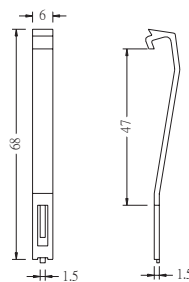
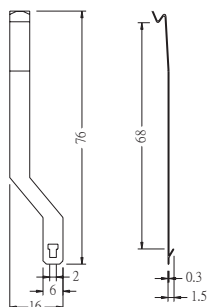

**DIMENSION(mm)**

**SUSQ-5**

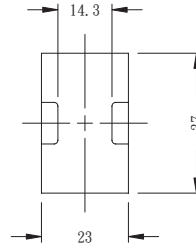
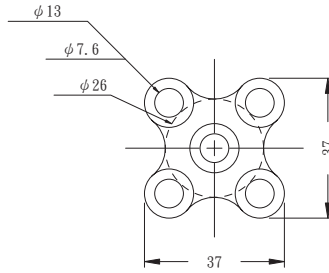

**PF-083BE**

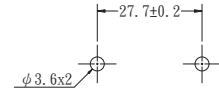
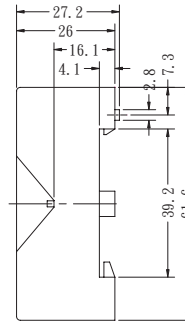
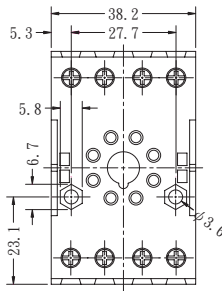
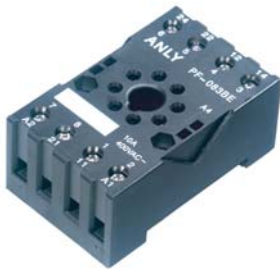

**PF-113BE**

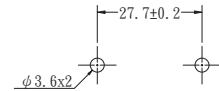
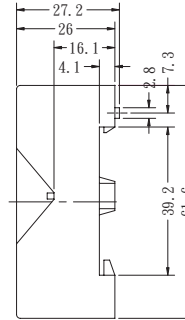
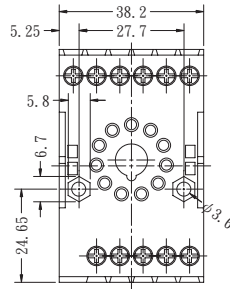

AGS-TECH Inc

Phone: +1-505-550-6501 and +1-505-565-5102 Fax: +1-505-814-5778

Email: sales@agstech.net Web: <http://www.agstech.net>